

SIEMENS



Application Example • 11/2016

# Application examples for High-Speed Counters (HSC)

TIA Portal, S7-1200 V4.2



<https://support.industry.siemens.com/cs/ww/en/view/109742346>

## Warranty and Liability

### Note

The Application Examples are not binding and do not claim to be complete with regard to configuration, equipment or any contingencies. The Application Examples do not represent customer-specific solutions. They are only intended to provide support for typical applications. You are responsible for the correct operation of the described products. These Application Examples do not relieve you of the responsibility of safely and professionally using, installing, operating and servicing equipment. When using these Application Examples, you recognize that we cannot be made liable for any damage/claims beyond the liability clause described. We reserve the right to make changes to these Application Examples at any time and without prior notice. If there are any deviations between the recommendations provided in this Application Example and other Siemens publications – e. g. catalogs – the contents of the other documents shall have priority.

We do not accept any liability for the information contained in this document. Any claims against us – based on whatever legal reason – resulting from the use of the examples, information, programs, engineering and performance data etc., described in this Application Example shall be excluded. Such an exclusion shall not apply in the case of mandatory liability, e. g. under the German Product Liability Act (“Produkthaftungsgesetz”), in case of intent, gross negligence, or injury of life, body or health, guarantee for the quality of a product, fraudulent concealment of a deficiency or breach of fundamental contractual obligations (“wesentliche Vertragspflichten”). The compensation for damages due to a breach of a fundamental contractual obligation is, however, limited to the foreseeable damage, typical for the type of contract, except in the event of intent or gross negligence or injury to life, body or health. The above provisions do not imply a change of the burden of proof to your detriment.

Any form of duplication or distribution of these Application Examples or excerpts hereof is prohibited without the expressed consent of Siemens AG.

### Security information

Siemens provides products and solutions with Industrial Security functions that support the secure operation of plants, systems, machines and networks.

In order to secure plants, systems, machines and networks against cyber threats it is necessary to implement (and to maintain continuously) a holistic, state-of-the-art Industrial Security concept. With this in mind, Siemens' products and solutions are only part of such a concept.

It is the client's responsibility to prevent unauthorized access to his plants, systems, machines and networks. Systems, machines and components should only be connected with the company's network or the Internet, when and insofar as this is required and the appropriate protective measures (for example, use of firewalls and network segmentation) have been taken.

In addition, the recommendations by Siemens regarding the respective protective measures have to be observed. For more information on Industrial Security, visit <http://www.siemens.com/industrialsecurity>.

Siemens' products and solutions undergo continuous development in order to make them even more secure. Siemens explicitly recommends to carry out updates as soon as the respective updates are available and always only to use the current product versions. Use of product versions that are no longer supported, and failure to apply latest updates may increase customer's exposure to cyber threats.

In order to always be informed about product updates, subscribe to the Siemens Industrial Security RSS Feed at <http://www.siemens.com/industrialsecurity>.

# Table of Contents

<b>Warranty and Liability .....</b>	<b>2</b>
<b>1 Introduction .....</b>	<b>4</b>
1.1 Overview.....	4
1.1.1 Measuring the speed in case of only one pulse or a few pulses per rotation .....	4
1.1.2 Determining the length by means of a HW gate .....	4
1.1.3 Determining the velocity by means of a HW gate .....	5
1.2 Components used .....	5
<b>2 Engineering: Speed measurement .....</b>	<b>6</b>
2.1 Hardware setup .....	6
2.2 Configuration .....	6
2.3 Integration into the user project.....	8
2.3.1 Period duration measurement using the "CTRL_HSC_EXT" instruction .....	8
2.3.2 Calculating the speed.....	9
<b>3 Engineering: Determining the length by means of a HW gate.....</b>	<b>10</b>
3.1 Hardware setup .....	10
3.2 Configuration .....	10
3.3 Integration into the user project.....	13
<b>4 Engineering: Determining the velocity by means of a HW gate .....</b>	<b>15</b>
4.1 Hardware setup .....	15
4.2 Configuration .....	15
4.3 Integration into the user project.....	19
<b>5 Appendix .....</b>	<b>23</b>
5.1 Service and support .....	23
5.2 Links and literature .....	24
5.3 Change documentation .....	24

# 1 Introduction

In automation technology, there are many fast events that cannot be detected in the program cycle of the main OB. The high-speed counters (HSC) of the S7-1200 help you to process even those events.

## 1.1 Overview

This application example presents three possible applications for high-speed counters (HSC) of an S7-1200.

### 1.1.1 Measuring the speed in case of only one pulse or a few pulses per rotation

In the first example, the instruction "CTRL\_HSC\_EXT" is used to determine the speed of a rotary motion in case of only one pulse or a few pulses per rotation.

Figure 1-1: Speed measurement in case of one pulse per rotation

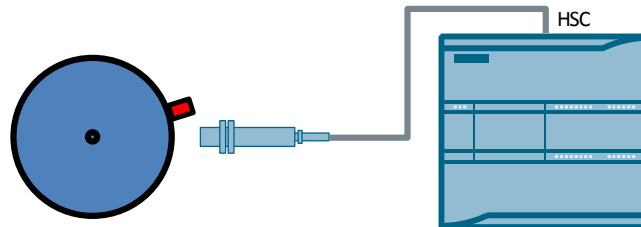

### 1.1.2 Determining the length by means of a HW gate

The second example explains the use of a HW gate. In this case, the pulses of an incremental encoder are counted as long as a light barrier detects an object. The number of pulses is used to calculate the size of an object given a known shifting length per pulse.

Figure 1-2: Determining the length by means of a HW gate

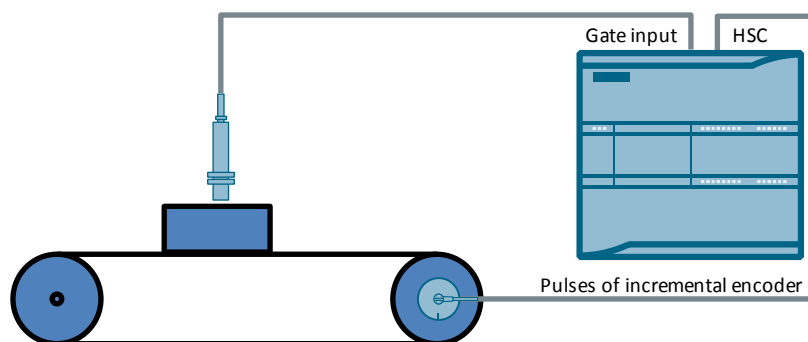

### 1.1.3 Determining the velocity by means of a HW gate

In the third example, the pulses of an incremental encoder (PWM) of the S7-1200 are counted by means of the HW gate as long as a light barrier detects an object. The number of pulses and the cycle time of the PWM signal are used to determine the duration of the HIGH signal at the HW gate. The velocity will be calculated from the duration and the defined known size of an object.

Figure 1-3: Determining the velocity by means of a HW gate

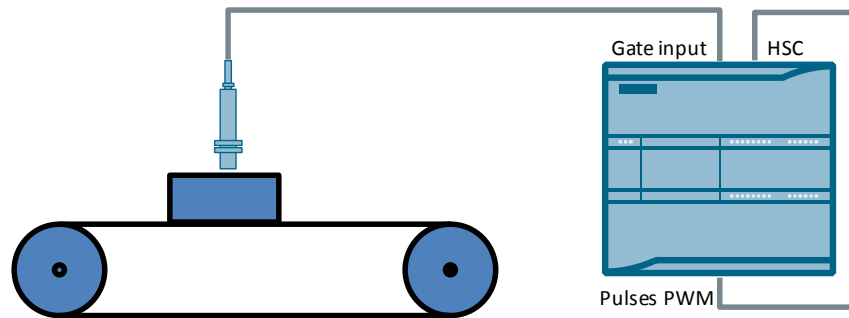

**Note** For precise time measurement, this example uses the impulse encoder (PWM) with a time base of 10 µs.

## 1.2 Components used

This application example has been created with the following hardware and software components:

Table 1-1

Component	Qty.	Article number	Note
CPU 1214C DC/DC/DC	1	6ES7214-1AG40-0XB0	Alternatively, any other CPU of the S7-1200 with firmware V4.2 can also be used.
STEP 7 Professional V14	1	6ES7822-1..04-..	-

This application example consists of the following components:

Table 1-2

Component	File name	Note
Documentation	109742346_HSC_S7_1200_DOCU_v10_en.docx	-
STEP 7 project	109742346_HSC_S7_1200_CODE_v10.zip	-

## 2 Engineering: Speed measurement

The example for measuring the speed in case of only one pulse or a few pulses per rotation has been realized in the STEP 7 project "Ex01\_Speed".

### 2.1 Hardware setup

Figure 2-1: Hardware setup for speed measurement

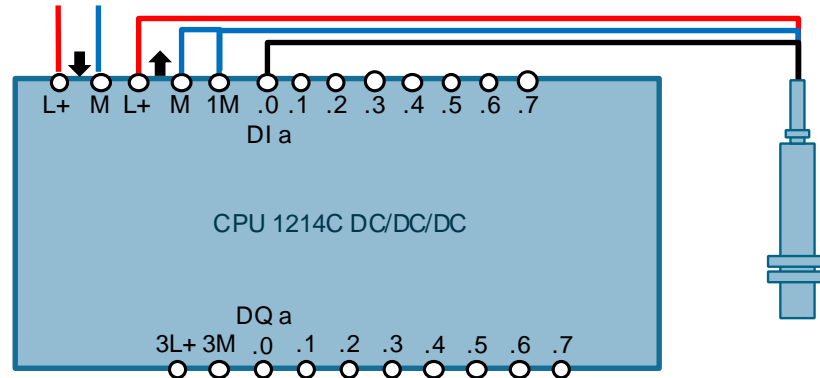

**Note** Use a precise and highly responsive sensor.  
Use shielded cables for high-frequency signals.

### 2.2 Configuration

#### Configuring a high-speed counter

To configure a high-speed counter, proceed as follows:

1. In the device or network view, select an S7-1200 CPU.
2. In the inspector window, go to "Properties > General > High speed counters (HSC)" and click the high-speed counter "HSC1".
3. Enable the high-speed counter in the "General" parameter group by ticking the corresponding checkbox. Under "Project information", you can enter a name and a comment for the counter.

Figure 2-2: Enabling the HSC

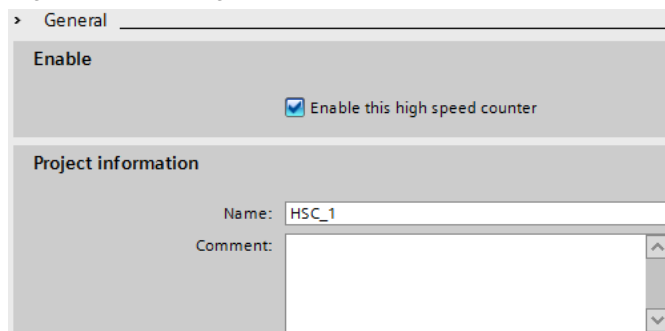

- In the "Function" parameter group, define the functioning of the counter as follows:
  - "Type of counting": "Period"
  - "Operating phase": "Single phase"
  - "Counting direction is specified by": "User program (internal direction control)"
  - "Initial counting direction": "Count up"
  - "Frequency measuring period": 1.0 sec

Figure 2-3: Function of the HSC

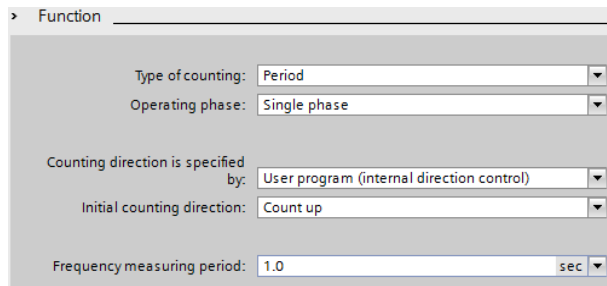

The screenshot shows the 'Function' parameter group with the following settings:

- Type of counting: Period
- Operating phase: Single phase
- Counting direction is specified by: User program (internal direction control)
- Initial counting direction: Count up
- Frequency measuring period: 1.0 sec

- In the "Hardware inputs" parameter group, go to "Clock generator input" and enter the hardware input "%I0.0".

Figure 2-4: Hardware input for clock generator

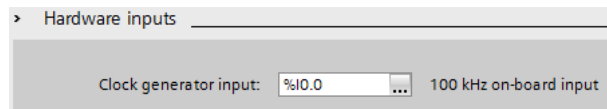

The screenshot shows the 'Hardware inputs' parameter group with the following setting:

- Clock generator input: %I0.0 (with a dropdown arrow) 100 kHz on-board input

- In the "I/O addresses" area, you can set the parameters of the input addresses.

### Configuring a digital input

To ensure safe detection of the clock generator pulses, the filter time of the digital input must be set to be less than the duration of the input signal. Set the filter time as follows:

- In the device or network view, select an S7-1200 CPU.
- In the inspector window, go to "Properties > General > DI 14/DQ 10 > Digital inputs" and click "Channel0".
- Set the "Input filters", e. g. "0.8 millisec".

Figure 2-5: Input filters for clock generator

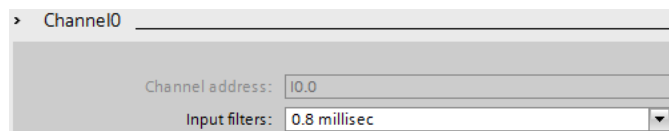

The screenshot shows the 'Channel0' parameter group with the following settings:

- Channel address: I0.0
- Input filters: 0.8 millisec

## 2.3 Integration into the user project

### 2.3.1 Period duration measurement using the "CTRL\_HSC\_EXT" instruction

#### Calling the "CTRL\_HSC\_EXT" instruction

Using the instruction "CTRL\_HSC\_EXT" ("Control high-speed counters (extended)"), you can configure and control the high-speed counters supported by the CPU. The "CTRL\_HSC\_EXT" instruction supports period duration measurement. It offers program access to the number of input pulses over a specified measurement interval. The instruction is called in the cyclic program as follows.

Figure 2-6: Calling the "CTRL\_HSC\_EXT" instruction

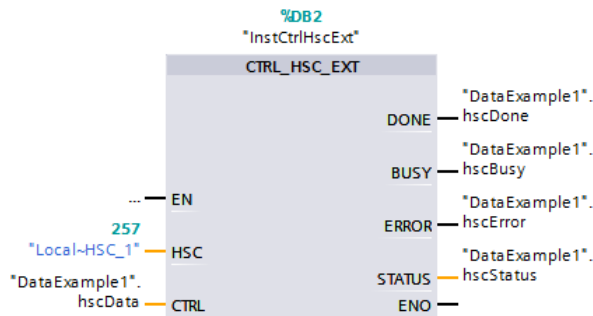

At the "HSC" input, specify the hardware identifier (HW-ID) of the high-speed counter "HSC1". The "CTRL" parameter requires a tag of system data type "HSC\_Period".

#### Using the system data type "HSC\_Period"

The tag of system data type "HSC\_Period" is defined in the data block "DataExample1".

Figure 2-7: Structure of the system data type "HSC\_Period"

DataExample1			
	Name	Data type	Start value
1	Static		
2	hscData	HSC_Period	
3	ElapsedTime	UDInt	0
4	EdgeCount	UDInt	0
5	EnHSC	Bool	TRUE
6	EnPeriod	Bool	false
7	NewPeriod	Int	1000

"ElapsedTime" specifies the time in nanoseconds between the last counting events of successive measurement intervals.

"EdgeCount" outputs the number of counting events received during a measurement interval.

With the start value "TRUE" for "EnHSC", the measurement is permanently enabled.

For the "NewPeriod" parameter, specify the interval of the period measurement in milliseconds. You can choose between 10, 100 and 1000. In the application example, 1000 is specified as measurement interval.

You can update the period by setting "TRUE" for "EnPeriod".



**Note**

For a detailed description of the "CTRL\_HSC\_EXT" instruction and of the "HSC\_Period" system data type, refer to the TIA Portal V14 online help or to the "SIMATIC STEP 7 Professional V14.0" system manual.

<https://support.industry.siemens.com/cs/ww/en/view/109742272>

**2.3.2 Calculating the speed**

The function block (FB) "CalcSpeed" is used to calculate the speed from the values determined from "elapsedTime" and "edgeCount" and then outputs the speed at the "speed" parameter.

Figure 2-8: Calling "CalcSpeed"

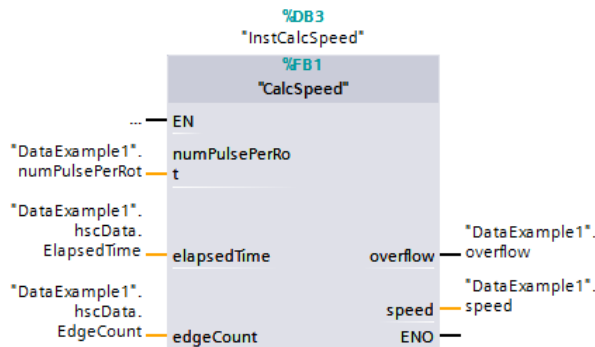

Table 2-1: Parameters of FB "CalcSpeed"

Name	P type	Data type	Comment
numPulsePerRot	IN	Int	Number of pulses per rotation
elapsedTime	IN	UDInt	Time in ns between the rising edges from "edgeCount"
edgeCount	IN	UDInt	Number of rising edges within the elapsed time from "elapsedTime"
overflow	OUT	Bool	Period overflow
speed	OUT	Real	Calculated speed in 1/min.

The FB first calculates the period in s by means of the following formula:

$$Period = \frac{elapsedTime}{edgeCount * 1.0E+09} * numPulsePerRot$$

The period will only be calculated if the value of "edgeCount" is greater than zero and the value of "elapsedTime" is within the range of 0 to 4.294.967.280. If "elapsedTime" has reached the value 4.294.967.295 (0xFFFF FFFF), a period overflow occurs. The overflow is displayed at the "overflow" output and the period is set to zero.

The "speed" parameter is calculated by means of the following formula:

$$speed = \frac{1}{Period} * 60.0$$

"speed" will only be calculated if the period is greater than zero.

## 3 Engineering: Determining the length by means of a HW gate

The example for determining the length of an object by means of the HW gate has been realized in the STEP 7 project in "Ex02\_Length".

### 3.1 Hardware setup

Figure 3-1: Hardware setup for calculating the length by means of the HW gate

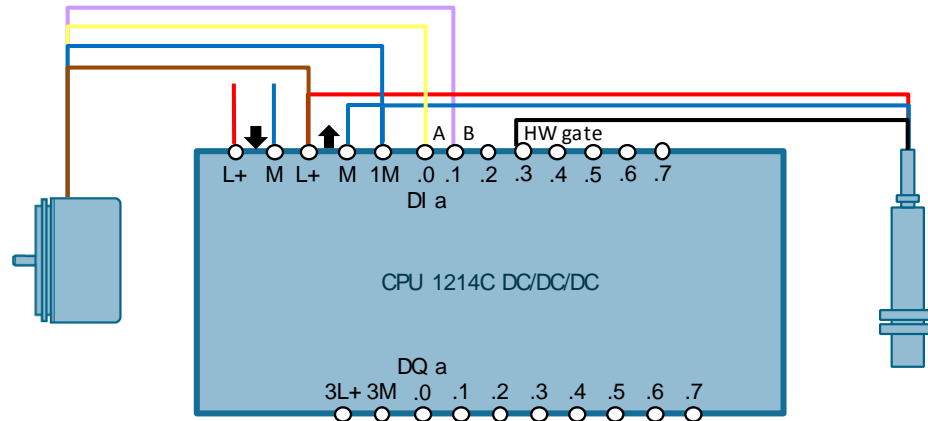

**Note** Use a precise and highly responsive sensor.  
Use shielded cables for high-frequency signals.

### 3.2 Configuration

#### Configuring a high-speed counter

To configure a high-speed counter, proceed as follows:

1. In the device or network view, select an S7-1200 CPU.
2. In the inspector window, go to "Properties > General > High speed counters (HSC)" and click the high-speed counter "HSC1".
3. Enable the high-speed counter in the "General" parameter group by ticking the corresponding checkbox. Under "Project information", you can enter a name and a comment for the counter.

Figure 3-2: Enabling the HSC

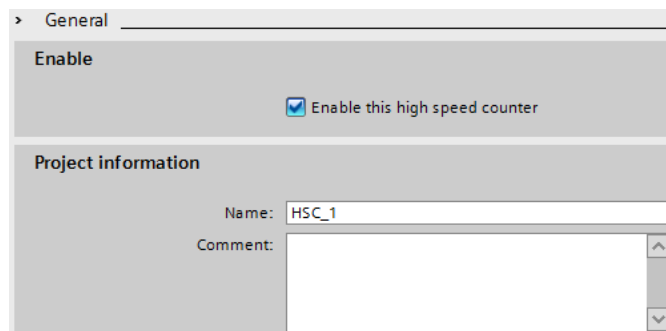

4. In the "Function" parameter group, define the functioning of the counter as follows:
  - "Type of counting": "Count"
  - "Operating phase": "A/B counter"
  - "Initial counting direction": "Count up"

Figure 3-3: Defining the function of the HSC

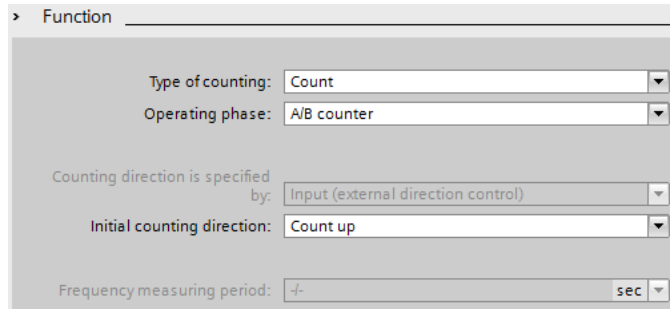

5. Enable "Use external gate input" in the "Gate input" parameter group. In the "Signal level of the hardware gate" drop-down list, select the option "Active high".

Figure 3-4: Enabling the hardware gate

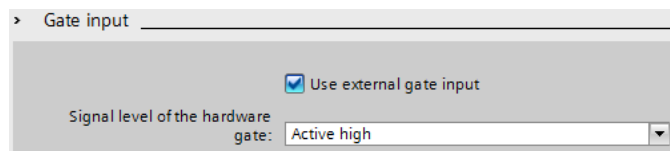

6. In the "Hardware inputs" parameter group, enter the following hardware inputs:
  - "Clock generator A input": "%I0.0"
  - "Clock generator B input": "%I0.1"
  - "Gate input": "%I0.3"

Figure 3-5: Hardware inputs

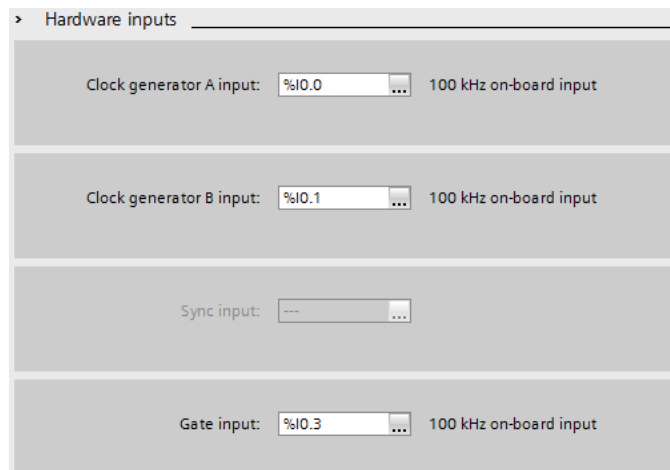

7. In the "I/O addresses" area, set the following parameters of the input addresses:

Figure 3-6: Parameters for input addresses

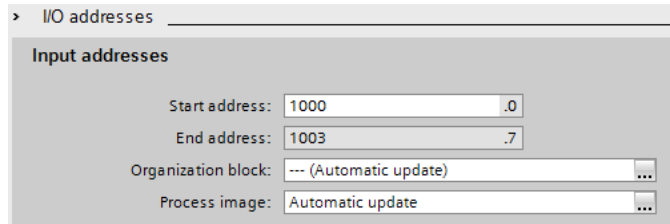

**Note** The S7-1200 stores the current value of the HSC as DINT in the input address that you have specified under "Start address". Here, you can query the value with ED1000.

### Configuring a digital input

To ensure safe detection of the pulses for clock generator A, clock generator B and the gate input, the filter time of the digital inputs must be set to be less than the duration of the input signal. Set the filter time as follows:

1. In the device or network view, select an S7-1200 CPU.
2. In the inspector window, go to "Properties > General > DI 14/DQ 10 > Digital inputs" and click "Channel0".
3. Set the "Input filters", e. g. to "10 microsec".

Figure 3-7: Input filters for clock generators A and B

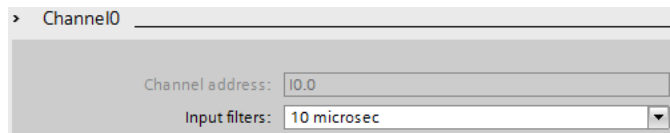

4. Repeat steps 2 and 3 for "Channel1".
5. In the inspector window, go to "Properties > General > DI 14/DQ 10 > Digital inputs" and click "Channel3".
6. Set the "Input filters", e. g. to "0.8 millisec".

Figure 3-8: Input filters for gate input

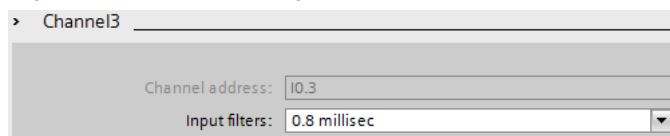

### 3.3 Integration into the user project

A light barrier is connected to the hardware input “Gate input” (HW gate) of HSC1. The pulses of an incremental encoder are counted by the high-speed counter HSC1 as long as the light barrier detects an object.

#### Calling the “CalcLength” function block

The function block (FB) “CalcLength” is used to calculate the length of an object. Figure 3-9: Calling “CalcLength”

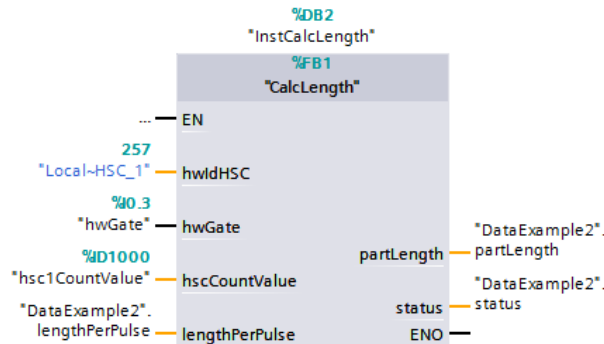

Table 3-1: Parameters of FB “CalcLength”

Name	P type	Data type	Comment
hwIdHSC	IN	HW_HSC	Hardware identifier (HW-ID) of the high-speed counter
hwGate	IN	Bool	Gate input signal (HW gate)
hscCountValue	IN	DInt	Counter value of the high-speed counter (HSC)
lengthPerPulse	IN	Real	Defined shifting length per pulse in mm
partLength	OUT	Real	Calculated length in mm
status	OUT	Word	Status of the “CTRL_HSC” instruction

#### Edge evaluation of the HW gate

The program first evaluates the falling edge of the HW gate.

Figure 3-10: Edge evaluation of the HW gate

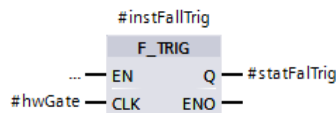

### Calculating the length

The falling edge "#statFalTrig" is used to calculate the size of an object "#partLength" from the number of pulses "#hscCountValue" and the defined shifting length per pulse "#lengthPerPulse".

Figure 3-11: Calculating the length

```

1 IF (#statFalTrig = TRUE)
2 THEN
3   #partLength := DINT_TO_REAL(#hscCountValue) * #lengthPerPulse;
4 END_IF;

```

### Calling the "CTRL\_HSC" instruction ("Control high-speed counters")

After calculation, you have to reset the count value of HSC1 to zero. Using the instruction "CTRL\_HSC", you can configure and control the high-speed counter supported by the CPU via the software. The falling edge at the HW gate "#statFalTrig" is used to set the bit at the "CV" input. Thus, the count value "0" specified at the "NEW\_CV" input will be loaded into the high-speed counter. At the "HSC" input, specify the hardware identifier (HW-ID) of the high-speed counter.

Figure 3-12: Calling "CTRL\_HSC"

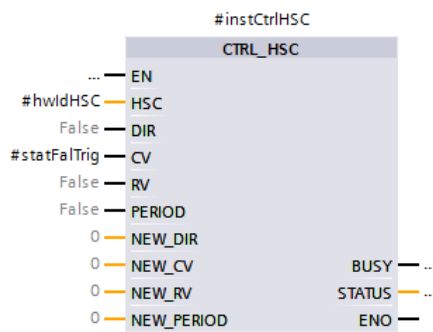

#### Note

For a detailed description of the "CTRL\_HSC" instruction, refer to the TIA Portal V14 online help or to the "SIMATIC STEP 7 Professional V14.0" system manual.

<https://support.industry.siemens.com/cs/ww/en/view/109742272>

## 4 Engineering: Determining the velocity by means of a HW gate

The example for determining the velocity of an object by means of the HW gate has been realized in the STEP 7 project in "Ex03\_Velo".

### 4.1 Hardware setup

Figure 4-1: Hardware setup for calculating the velocity by means of the HW gate

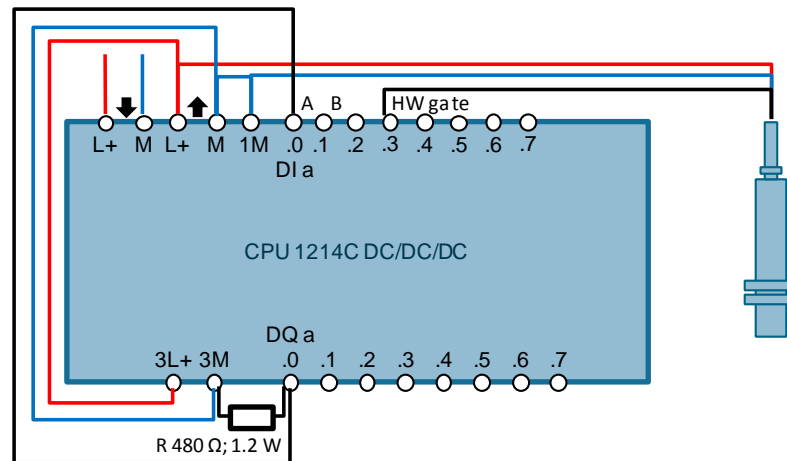

**Note** Depending on the pulse receiver and the cable used, an additional load resistor (for at least 10 % of the rated current) may improve the quality of the pulse signals and the interference immunity.

**Note** Use a precise and highly responsive sensor.  
Use shielded cables for high-frequency signals.

### 4.2 Configuration

#### Configuring the pulse generator

To configure a pulse generator (PWM), proceed as follows:

1. In the device or network view, select an S7-1200 CPU.
2. In the inspector window under "Properties > General > Pulse generators (PTO/PWM)", click on "PTO1/PWM1".
3. Enable the pulse generator in the "General" parameter group by ticking the corresponding checkbox. Under "Project information", you can enter a name and a comment for the pulse generator.

Figure 4-2: Enabling the pulse generator

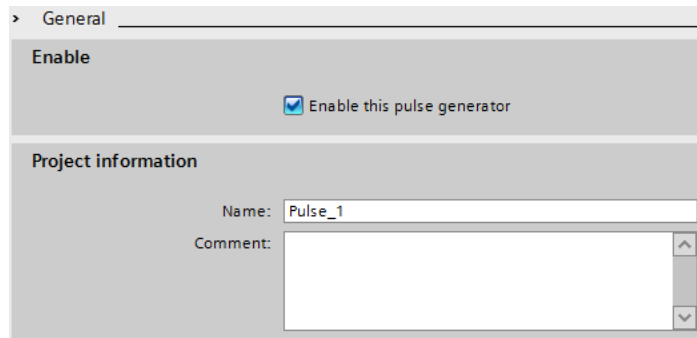

4. Define the pulse options of the pulse generator in the "Parameter assignment" parameter group as follows:
  - "Signal type" "PWM"
  - "Time base" "Microseconds"
  - "Pulse duration format" "Thousandths"
  - "Cycle time" 10  $\mu$ s
  - "Initial pulse duration": 500 "Thousandths"
  - Enable "Allow runtime modification of the cycle time"

Figure 4-3: Defining pulse options of the pulse generator

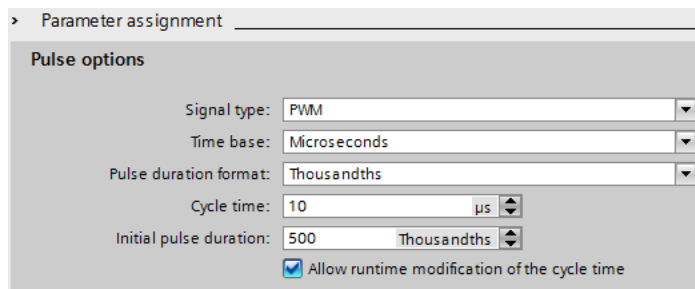

**Note**

The shorter the cycle time, the more precisely the velocity can be determined.

5. In the "Hardware outputs" parameter group, enter the hardware output "%Q0.0" for the "Pulse output":

Figure 4-4: Hardware outputs

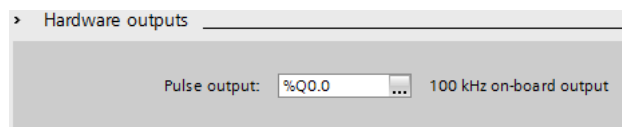



6. In the "I/O addresses" area, set the parameters of the output addresses.

Figure 4-5: Parameters for output addresses

**Note**

You can change the pulse duration and the cycle time by describing the output word QW1008 or the output double word QD1010.

**Configuring a high-speed counter**

To configure a high-speed counter, proceed as follows:

1. In the device or network view, select an S7-1200 CPU.
2. In the inspector window, go to "Properties > General > High speed counters (HSC)" and click the high-speed counter "HSC1".
3. Enable the high-speed counter in the "General" parameter group by ticking the corresponding checkbox. Under "Project information", you can enter a name and a comment for the counter.

Figure 4-6: Enabling the HSC

4. In the "Function" parameter group, define the functioning of the counter as follows:
  - "Type of counting": "Count"
  - "Operating phase": "Single phase"
  - "Counting direction is specified by": "User program (internal direction control)"
  - "Initial counting direction": "Count up"

Figure 4-7: Defining the function of the HSC

The 'Function' configuration window includes the following settings:

- Type of counting: Count
- Operating phase: Single phase
- Counting direction is specified by: User program (internal direction control)
- Initial counting direction: Count up
- Frequency measuring period: +/- sec

5. Enable the "Use external gate input" checkbox in the "Gate input" parameter group. In the "Signal level of the hardware gate" drop-down list, select the option "Active high".

Figure 4-8: Enabling the hardware gate

The 'Gate input' configuration window shows:

- Use external gate input
- Signal level of the hardware gate: Active high

6. In the "Hardware inputs" parameter group, enter the following hardware inputs:
  - "Clock generator input": "%I0.0"
  - "Gate input": "%I0.3"

Figure 4-9: Hardware inputs

The 'Hardware inputs' configuration window shows the following settings:

- Clock generator input: %I0.0 100 kHz on-board input
- Direction input: ---
- Sync input: ---
- Gate input: %I0.3 100 kHz on-board input

- In the "I/O addresses" area, set the following parameters of the input addresses:

Figure 4-10: Parameters for input addresses

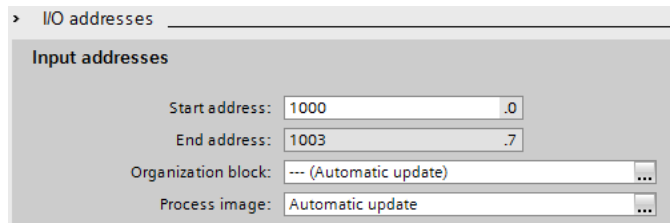

**Note**

The S7-1200 stores the current value of the HSC as DINT in the input address that you have specified under "Start address". Here, you can query the value with ED1000.

**Configuring a digital input**

To ensure safe detection of the pulses of inputs for the clock generator and the gate input, the filter time of the digital inputs must be set to be less than the duration of the input signal. Set the filter time as follows:

- In the device or network view, select an S7-1200 CPU.
- In the inspector window, go to "Properties > General > DI 14/DQ 10 > Digital inputs" and click "Channel0".
- Set the "Input filters", e. g. to "0.8 microsec".

Figure 4-11: Input filters for clock generator

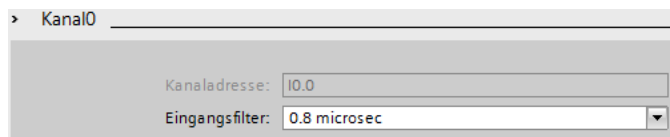

- In the inspector window, go to "Properties > General > DI 14/DQ 10 > Digital inputs" and click "Channel3".
- Set the "Input filters", e. g. to "0.8 millisc".

Figure 4-12: Input filters for gate input

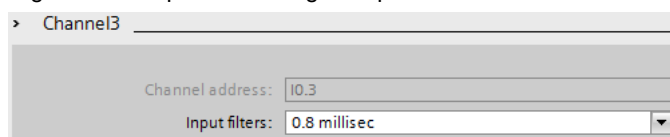

**4.3 Integration into the user project**

A light barrier is connected to the hardware input "Gate input" (HW gate) of HSC1. The pulses of a pulse generator are counted by the high-speed counter HSC1 as long as the light barrier detects an object. The pulses of the pulse generator are generated by the program.

### Calling the "CalcVelo" function block

The function block (FB) "CalcVelo" is used to calculate the velocity of an object.

Figure 4-13: Calling "CalcVelo"

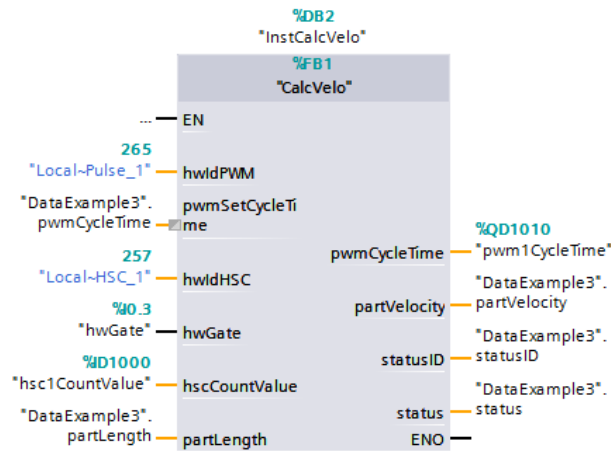

Table 4-1: Parameters of FB "CalcVelo"

Name	P type	Data type	Comment
hwdPWM	IN	HW_PWM	Hardware identifier (HW-ID) of the pulse generator
pwmSetCycleTime	IN	DInt	Specified cycle time for PWM in $\mu$ s
hwdHSC	IN	HW_HSC	Hardware identifier (HW-ID) of the high-speed counter
hwGate	IN	Bool	Gate input signal (HW gate)
hscCountValue	IN	DInt	Counter value of the high-speed counter (HSC)
partLength	OUT	Real	Defined length of an object in mm
pwmCycleTime	IN	DInt	Cycle time output for PWM in $\mu$ s
partVelocity	OUT	Real	Calculated velocity of an object in mm/s
statusID	OUT	UInt	Status ID of instructions The following applies: statusID = 1: Status of "CTRL_PWM" at "status" statusID = 2: Status of "CTRL_HSC" at "status"
status	OUT	Word	Status of the instructions "CTRL_PWM" and "CTRL_HSC"

### Specified cycle time for PWM1

In the program, the cycle time of the "#pwmSetCycleTime" input first is assigned to the "#pwmCycleTime" output. This means that the cycle time defined in the "DataExample3".pwmCycleTime tag is written into the output double word QD1010 ("pwm1CycleTime") of pulse generator PWM1.

Figure 4-14: Specified cycle time for PWM1

```
1 #pwmCycleTime := #pwmSetCycleTime;
```

### Calling the "CTRL\_PWM" instruction ("pulse width modulation")

Use the "CTRL\_PWM" instruction to enable a pulse generator via the software. At the "PWM" input, specify the hardware identifier (HW-ID) of the pulse generator. The pulse generator is enabled with "ENABLE = true".

Figure 4-15: Calling the "CTRL\_PWM" instruction

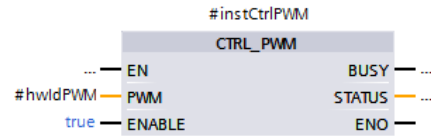

### Edge evaluation of the HW gate

To calculate the velocity, the falling edge of the HW gate will be evaluated first.

Figure 4-16: Edge evaluation of the HW gate

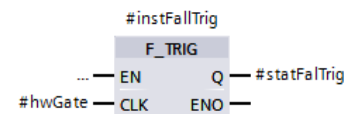

### Calculating the velocity

The falling edge "#statFalTrig" is used to calculate the velocity of an object "#partVelocity" from the following values:

- Defined size of an object "#partLength"
- Number of pulses "#hscCountValue"
- Cycle time of the pulse generator "#pwmSetCycleTime"

If the motor is in standstill, there is no falling edge. After a waiting time is over, the tag for the velocity of an object "#partVelocity" is set to zero.

Figure 4-17: Calculating the velocity

```

1 // Calculate speed of part
2 IF (#statFalTrig = TRUE)
3   AND (#hscCountValue > 0)
4   AND (#instIONFalTrig.Q = FALSE)
5 THEN
6   #partVelocity := #partLength / DINT_TO_REAL(#hscCountValue) / DINT_TO_REAL(#pwmSetCycleTime) * #MILLION;
7 END_IF;
8
9 // Start timer, if no falling edge of "hwGate"
10 #instIONFalTrig(IN := NOT #statFalTrig,
11   PI := #WAIT_SPEED_ZERO);
12
13 // Set speed to zero, if time elapsed
14 IF #instIONFalTrig.Q
15 THEN
16   #partVelocity := 0;
17 END_IF;

```

**Calling the "CTRL\_HSC" instruction ("Control high-speed counters")**

After calculation, the count value of HSC1 must be reset to zero. Using the instruction "CTRL\_HSC", you can configure and control the high-speed counter supported by the CPU via the software. The falling edge at the HW gate "#statFalTrig" is used to set the bit at the "CV" input. Thus, the count value "0" specified at the "NEW\_CV" input will be loaded into the high-speed counter. At the "HSC" input, specify the hardware identifier (HW-ID) of the high-speed counter.

Figure 4-18: Calling "CTRL\_HSC"

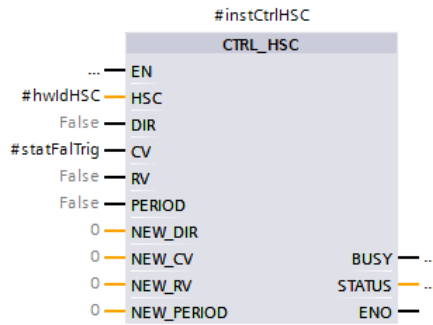

**Note**

For a detailed description of the "CTRL\_HSC" instruction, refer to the TIA Portal V14 online help or to the "SIMATIC STEP 7 Professional V14.0" system manual.

<https://support.industry.siemens.com/cs/ww/en/view/109742272>

## 5 Appendix

### 5.1 Service and support

#### Industry Online Support

Do you have any questions or need support?

Siemens Industry Online Support offers access to our entire service and support know-how as well as to our services.

Siemens Industry Online Support is the central address for information on our products, solutions and services.

Product information, manuals, downloads, FAQs and application examples – all information is accessible with just a few mouse clicks at

<https://support.industry.siemens.com/> .

#### Technical Support

Siemens Industry's Technical Support offers quick and competent support regarding all technical queries with numerous tailor-made offers – from basic support to individual support contracts.

Please address your requests to the Technical Support via the web form:

[www.siemens.com/industry/supportrequest](http://www.siemens.com/industry/supportrequest) .

#### Service offer

Our service offer comprises, among other things, the following services:

- Product Training
- Plant Data Services
- Spare Parts Services
- Repair Services
- Field & Maintenance Services
- Retrofit & Modernization Services
- Service Programs and Agreements

Detailed information on our service offer is available in the Service Catalog:

<https://support.industry.siemens.com/cs/sc>

#### Industry Online Support app

Thanks to the "Siemens Industry Online Support" app, you will get optimum support even when you are on the move. The app is available for Apple iOS, Android and Windows Phone.

<https://support.industry.siemens.com/cs/de/en/sc/2067>

## 5.2 Links and literature

Table 5-1

No.	Topic
\1\	Siemens Industry Online Support <a href="https://support.industry.siemens.com">https://support.industry.siemens.com</a>
\2\	<a href="https://support.industry.siemens.com/cs/ww/en/view/109742346">https://support.industry.siemens.com/cs/ww/en/view/109742346</a>
\3\	SIMATIC STEP 7 Professional V14.0 system manual <a href="https://support.industry.siemens.com/cs/ww/en/view/109742272">https://support.industry.siemens.com/cs/ww/en/view/109742272</a>
\4\	System Manual SIMATIC S7-1200 automation system <a href="https://support.industry.siemens.com/cs/ww/en/view/109741593">https://support.industry.siemens.com/cs/ww/en/view/109741593</a>

## 5.3 Change documentation

Table 5-2

Version	Date	Modifications
V1.0	11/2016	First version