

SIEMENS



Manual

SIMATIC

S7-1500 / ET 200MP

Analog Input Module
AI 8xU/I/RTD BA (6ES7531-7QF00-0AB0)

Edition

03/2019

support.industry.siemens.com

SIEMENS

SIMATIC

S7-1500/ET 200MP
Analog Input Module
AI 8xU/I/R/RTD BA
(6ES7531-7QF00-0AB0)

Manual

Preface

Documentation guide

1

Product overview

2

Wiring

3

Parameters/address space

4

Interrupts/diagnostics alarms

5

Technical specifications

6

Dimensional drawing

A

Parameter data records

B

Representation of analog
values

C

Legal information

Warning notice system

This manual contains notices you have to observe in order to ensure your personal safety, as well as to prevent damage to property. The notices referring to your personal safety are highlighted in the manual by a safety alert symbol, notices referring only to property damage have no safety alert symbol. These notices shown below are graded according to the degree of danger.

⚠ DANGER
indicates that death or severe personal injury will result if proper precautions are not taken.
⚠ WARNING
indicates that death or severe personal injury may result if proper precautions are not taken.
⚠ CAUTION
indicates that minor personal injury can result if proper precautions are not taken.
NOTICE
indicates that property damage can result if proper precautions are not taken.

If more than one degree of danger is present, the warning notice representing the highest degree of danger will be used. A notice warning of injury to persons with a safety alert symbol may also include a warning relating to property damage.

Qualified Personnel

The product/system described in this documentation may be operated only by **personnel qualified** for the specific task in accordance with the relevant documentation, in particular its warning notices and safety instructions. Qualified personnel are those who, based on their training and experience, are capable of identifying risks and avoiding potential hazards when working with these products/systems.

Proper use of Siemens products

Note the following:

⚠ WARNING
Siemens products may only be used for the applications described in the catalog and in the relevant technical documentation. If products and components from other manufacturers are used, these must be recommended or approved by Siemens. Proper transport, storage, installation, assembly, commissioning, operation and maintenance are required to ensure that the products operate safely and without any problems. The permissible ambient conditions must be complied with. The information in the relevant documentation must be observed.

Trademarks

All names identified by ® are registered trademarks of Siemens AG. The remaining trademarks in this publication may be trademarks whose use by third parties for their own purposes could violate the rights of the owner.

Disclaimer of Liability

We have reviewed the contents of this publication to ensure consistency with the hardware and software described. Since variance cannot be precluded entirely, we cannot guarantee full consistency. However, the information in this publication is reviewed regularly and any necessary corrections are included in subsequent editions.

Preface

Purpose of the documentation

This manual supplements the system manual S7-1500/ET 200MP (<https://support.industry.siemens.com/cs/ww/en/view/59191792>).

Functions that relate in general to the systems are described in this system manual.

The information provided in this manual and in the system/function manuals supports you in commissioning the systems.

Conventions

The term "CPU" is used in this manual both for the CPUs of the S7-1500 automation system, as well as for interface modules of the ET 200MP distributed I/O system.

Please also observe notes marked as follows:

Note

A note contains important information on the product described in the documentation, on the handling of the product or on the section of the documentation to which particular attention should be paid.

Recycling and disposal

For environmentally friendly recycling and disposal of your old equipment, contact a certified electronic waste disposal company and dispose of the equipment according to the applicable regulations in your country.

Security information

Siemens provides products and solutions with industrial security functions that support the secure operation of plants, systems, machines and networks.

In order to protect plants, systems, machines and networks against cyber threats, it is necessary to implement – and continuously maintain – a holistic, state-of-the-art industrial security concept. Siemens' products and solutions constitute one element of such a concept.

Customers are responsible for preventing unauthorized access to their plants, systems, machines and networks. Such systems, machines and components should only be connected to an enterprise network or the internet if and to the extent such a connection is necessary and only when appropriate security measures (e.g. firewalls and/or network segmentation) are in place.

For additional information on industrial security measures that can be implemented, please visit (<https://www.siemens.com/industrialsecurity>).

Siemens' products and solutions undergo continuous development to make them more secure. Siemens strongly recommends that product updates are applied as soon as they are available and that the latest product versions are used. Use of product versions that are no longer supported, and failure to apply the latest updates may increase customers' exposure to cyber threats.

To stay informed about product updates, subscribe to the Siemens Industrial Security RSS Feed visit (<https://www.siemens.com/industrialsecurity>).

Open Source Software

Open-source software is used in the firmware of the I/O modules. Open Source Software is provided free of charge. We are liable for the product described, including the open-source software contained in it, pursuant to the conditions applicable to the product. Siemens accepts no liability for the use of the open source software over and above the intended program sequence, or for any faults caused by modifications to the software.

For legal reasons, we are obliged to publish the original text of the license conditions and copyright notices. Please read the information relating to this on the Internet (<https://support.industry.siemens.com/cs/ww/en/view/109757558>).

Table of contents

	Preface	3
1	Documentation guide	6
2	Product overview	10
	2.1 Properties	10
3	Wiring	13
4	Parameters/address space	18
	4.1 Measuring types and ranges	18
	4.2 Parameters	20
	4.3 Declaration of parameters	23
	4.4 Address space	25
5	Interrupts/diagnostics alarms	31
	5.1 Status and error displays	31
	5.2 Interrupts	33
	5.3 Diagnostics alarms.....	35
6	Technical specifications	36
A	Dimensional drawing	43
B	Parameter data records	45
	B.1 Parameter assignment and structure of the parameter data records.....	45
C	Representation of analog values	52
	C.1 Representation of input ranges.....	53
	C.2 Representation of analog values in voltage measuring ranges.....	54
	C.3 Representation of analog values in the current measuring ranges	55
	C.4 Representation of the analog values of resistance-based sensors/resistance thermometers	56
	C.5 Measured values for wire break diagnostic	59

Documentation guide

The documentation for the SIMATIC S7-1500 automation system and the SIMATIC ET 200MP distributed I/O system is arranged into three areas. This arrangement enables you to access the specific content you require.

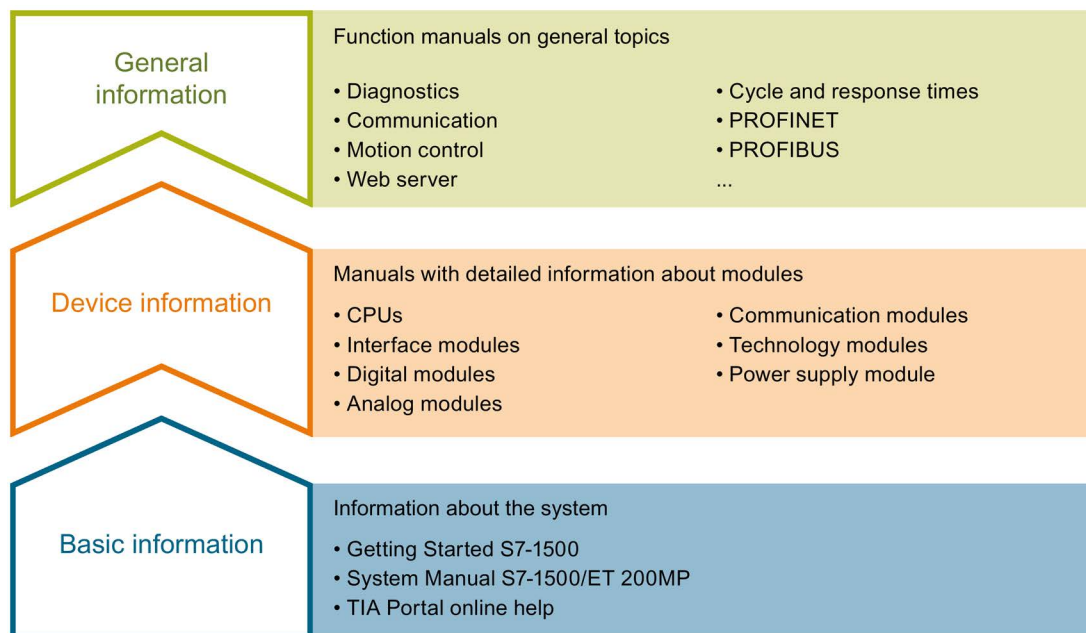

Basic information

The System Manual and Getting Started describe in detail the configuration, installation, wiring and commissioning of the SIMATIC S7-1500 and ET 200MP systems. The STEP 7 online help supports you in the configuration and programming.

Device information

Product manuals contain a compact description of the module-specific information, such as properties, wiring diagrams, characteristics and technical specifications.

General information

The function manuals contain detailed descriptions on general topics regarding the SIMATIC S7-1500 and ET 200MP systems, e.g. diagnostics, communication, motion control, Web server, OPC UA.

You can download the documentation free of charge from the Internet (<https://support.industry.siemens.com/cs/ww/en/view/109742691>).

Changes and supplements to the manuals are documented in a Product Information.

You can download the product information free of charge from the Internet (<https://support.industry.siemens.com/cs/us/en/view/68052815>).

Manual Collection S7-1500/ET 200MP

The Manual Collection contains the complete documentation on the SIMATIC S7-1500 automation system and the ET 200MP distributed I/O system gathered together in one file.

You can find the Manual Collection on the Internet (<https://support.industry.siemens.com/cs/ww/en/view/86140384>).

SIMATIC S7-1500 comparison list for programming languages

The comparison list contains an overview of which instructions and functions you can use for which controller families.

You can find the comparison list on the Internet (<https://support.industry.siemens.com/cs/ww/en/view/86630375>).

"mySupport"

With "mySupport", your personal workspace, you make the best out of your Industry Online Support.

In "mySupport", you can save filters, favorites and tags, request CAx data and compile your personal library in the Documentation area. In addition, your data is already filled out in support requests and you can get an overview of your current requests at any time.

You must register once to use the full functionality of "mySupport".

You can find "mySupport" on the Internet (<https://support.industry.siemens.com/My/ww/en>).

"mySupport" - Documentation

In the Documentation area in "mySupport" you can combine entire manuals or only parts of these to your own manual.

You can export the manual as PDF file or in a format that can be edited later.

You can find "mySupport" - Documentation on the Internet (<http://support.industry.siemens.com/My/ww/en/documentation>).

"mySupport" - CAx data

In the CAx data area in "mySupport", you can access the current product data for your CAx or CAe system.

You configure your own download package with a few clicks.

In doing so you can select:

- Product images, 2D dimension drawings, 3D models, internal circuit diagrams, EPLAN macro files
- Manuals, characteristics, operating manuals, certificates
- Product master data

You can find "mySupport" - CAx data on the Internet (<http://support.industry.siemens.com/my/ww/en/CAxOnline>).

Application examples

The application examples support you with various tools and examples for solving your automation tasks. Solutions are shown in interplay with multiple components in the system - separated from the focus on individual products.

You will find the application examples on the Internet (<https://support.industry.siemens.com/sc/ww/en/sc/2054>).

TIA Selection Tool

With the TIA Selection Tool, you can select, configure and order devices for Totally Integrated Automation (TIA).

This tool is the successor of the SIMATIC Selection Tool and combines the known configurators for automation technology into one tool.

With the TIA Selection Tool, you can generate a complete order list from your product selection or product configuration.

You can find the TIA Selection Tool on the Internet (<http://w3.siemens.com/mcms/topics/en/simatic/tia-selection-tool>).

SIMATIC Automation Tool

You can use the SIMATIC Automation Tool to perform commissioning and maintenance activities simultaneously on various SIMATIC S7 stations as a bulk operation independent of the TIA Portal.

General function overview:

- Network browsing and creation of a table showing the accessible devices in the network.
- Flashing of device LEDs or HMI display to locate a device
- Downloading of addresses (IP, subnet, gateway) to a device
- Downloading the PROFINET name (station name) to a device
- Placing a CPU in RUN or STOP mode
- Setting the time in a CPU to the current time of your PG/PC
- Downloading a new program to a CPU or an HMI device
- Downloading from CPU, downloading to CPU or deleting recipe data from a CPU
- Downloading from CPU or deleting data log data from a CPU
- Backup/restore of data from/to a backup file for CPUs and HMI devices
- Downloading service data from a CPU
- Reading the diagnostics buffer of a CPU
- Performing a CPU memory reset
- Resetting devices to factory settings
- Downloading a firmware update to a device

You can find the SIMATIC Automation Tool on the Internet (<https://support.industry.siemens.com/cs/ww/en/view/98161300>).

PRONETA

With SIEMENS PRONETA (PROFINET network analysis), you analyze the PROFINET network during commissioning. PRONETA features two core functions:

- The topology overview independently scans PROFINET network and all connected components.
- The IO check is a fast test of the wiring and the module configuration of a system.

You can find SIEMENS PRONETA on the Internet

(<https://support.industry.siemens.com/cs/ww/en/view/67460624>).

SINETPLAN

SINETPLAN, the Siemens Network Planner, supports you in planning automation systems and networks based on PROFINET. The tool facilitates professional and predictive dimensioning of your PROFINET installation as early as in the planning stage. In addition, SINETPLAN supports you during network optimization and helps you to exploit network resources optimally and to plan reserves. This helps to prevent problems in commissioning or failures during productive operation even in advance of a planned operation. This increases the availability of the production plant and helps improve operational safety.

The advantages at a glance

- Network optimization thanks to port-specific calculation of the network load
- Increased production availability thanks to online scan and verification of existing systems
- Transparency before commissioning through importing and simulation of existing STEP 7 projects
- Efficiency through securing existing investments in the long term and optimal exploitation of resources

You can find SINETPLAN on the Internet (<https://www.siemens.com/sinetplan>).

Product overview

2.1 Properties

Article number

6ES7531-7QF00-0AB0

View of the module

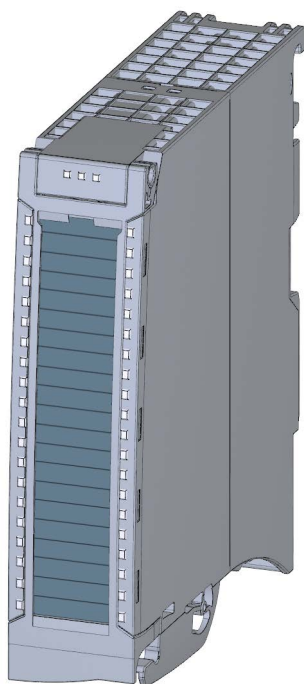

Figure 2-1 View of the AI 8xU/I/R/RTD BA module

Properties

The module has the following technical properties:

- 8 analog inputs
- Voltage measurement type can be set per channel
- Current measurement type can be set per channel
- Resistor measurement type can be set per channel
- Resistance thermometer (RTD) measuring type can be set per channel
- Resolution 16 bits including sign
- Configurable diagnostics (per channel)
- Hardware interrupt on limit violation can be set per channel (two low and two high limits per channel)

The module supports the following functions:

Table 2- 1 Version dependencies of the module functions

Function	Firmware version of the module	Configuration software	
		STEP 7 (TIA Portal) as of V15.1 and HSP 0275	GSD file in STEP 7 (TIA Portal) V12 or higher, or STEP 7 V5.5 SP3 or higher
Firmware update	V1.0.0 or higher	X	X
Identification data I&M0 to I&M3	V1.0.0 or higher	X	X
Parameter assignment in RUN	V1.0.0 or higher	X	X
Isochronous mode	---	---	---
Calibration in runtime	---	---	---
Module-internal Shared Input (MSI)	V1.0.0 or higher	X (PROFINET IO only)	X (PROFINET IO only)
Configurable submodules / submodules for Shared Device	V1.0.0 or higher	X (PROFINET IO only)	X (PROFINET IO only)

You can configure the module with STEP 7 (TIA Portal) and with a GSD file.

Accessories

The following accessories are supplied with the module and can also be ordered separately as spare parts:

- Shield bracket
- Shield terminal
- Power supply element
- Labeling strips
- U connector
- Universal front door

Other components

For example, you order the front connector including the potential bridge and cable tie separately.

You can find additional information on accessories and the article number in the system manual S7-1500/ET 200MP

(<https://support.industry.siemens.com/cs/ww/en/view/59191792>).

Wiring

This section contains the block diagram of the module and outlines various connection options.

You can find information on wiring the front connector, creating a cable shield, etc. in the Wiring section of the system manual S7-1500/ET 200MP (<https://support.industry.siemens.com/cs/ww/en/view/59191792>).

Note

- You may use and combine the different wiring options for all channels.
 - Do not insert the potential jumpers supplied with the front connector.
-

Abbreviations used

Meaning of the abbreviations used in the following figures:

U_n+/U_n-	Voltage input channel n (voltage only)
M_n+/M_n-	Measuring input channel n
I_n+/I_n-	Current input channel n (current only)
$I_{c,n}+/I_{c,n}-$	Current output for RTD, channel n
M_{ANA}	Reference potential of the analog circuit

Infeed element

The module does not require supply voltage through the infeed element. The infeed element is inserted on the front connector and serves solely for shielding.



Figure 3-1 Infeed element

Block diagram and pin assignment for voltage measurement

The example in the following figure shows the pin assignment for voltage measurement.

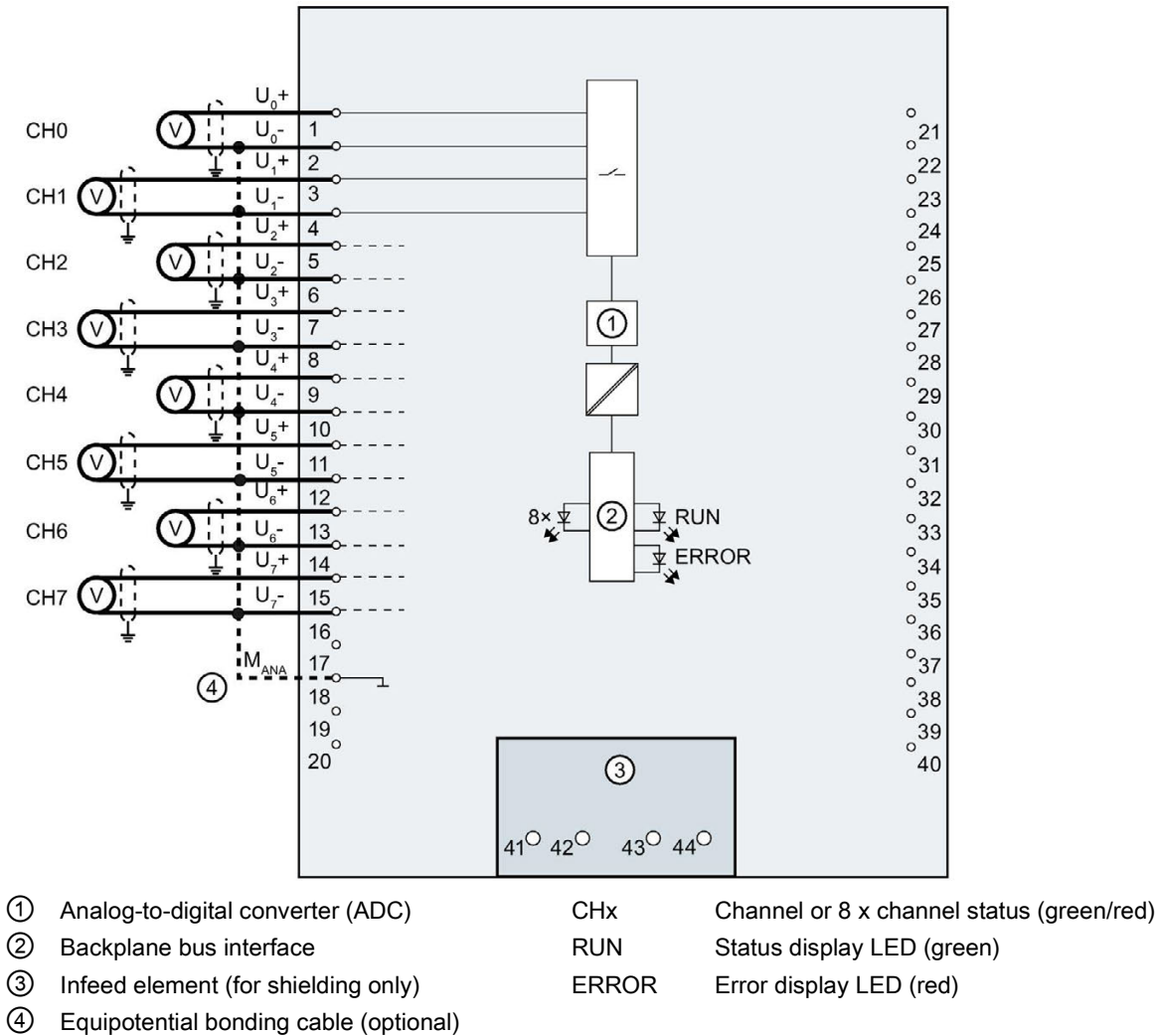

Figure 3-2 Block diagram and pin assignment for voltage measurement

Connection: 4-wire transmitters for current measurement

The example in the following figure shows the pin assignment for current measurement with 4-wire transmitters.

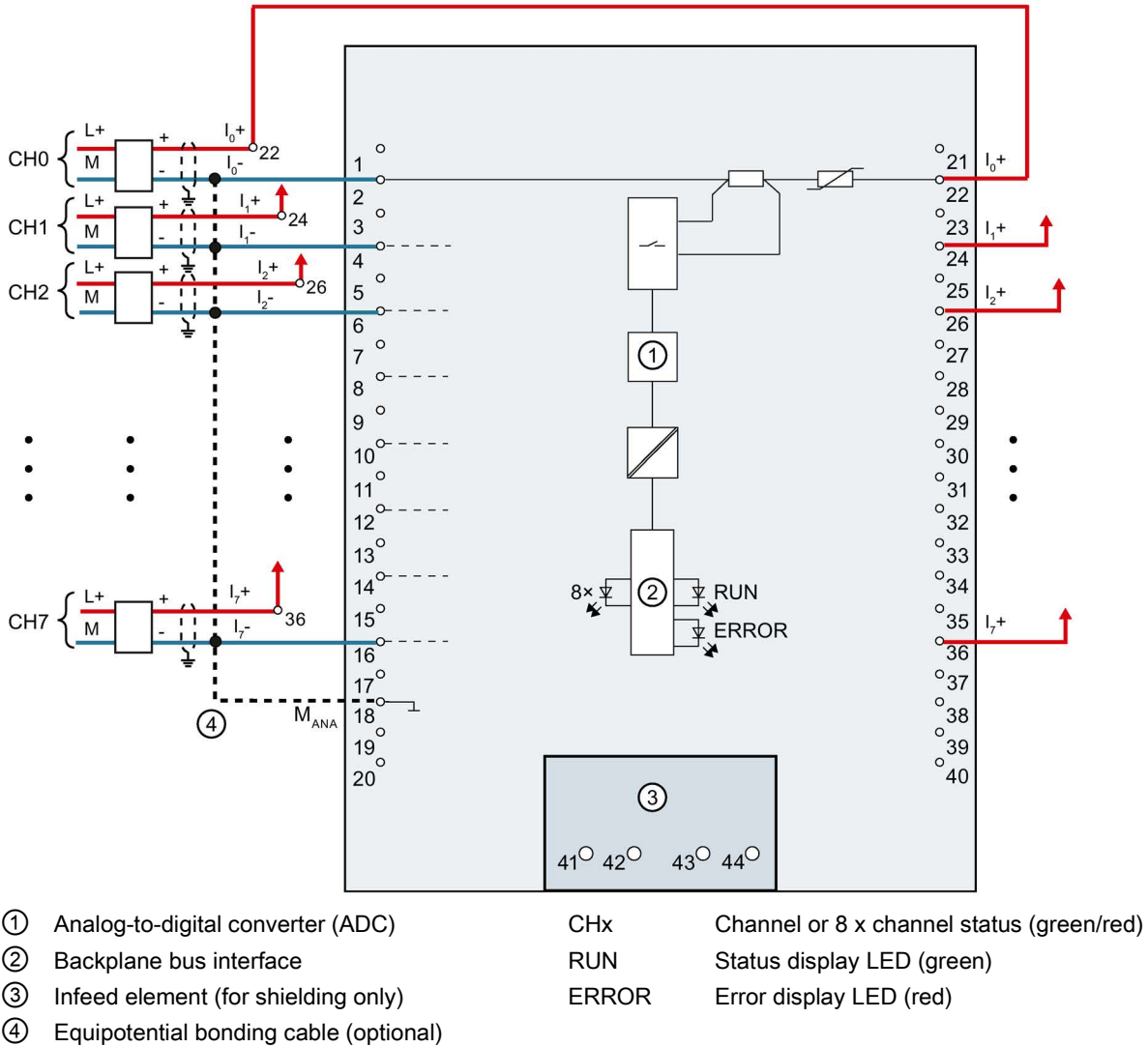
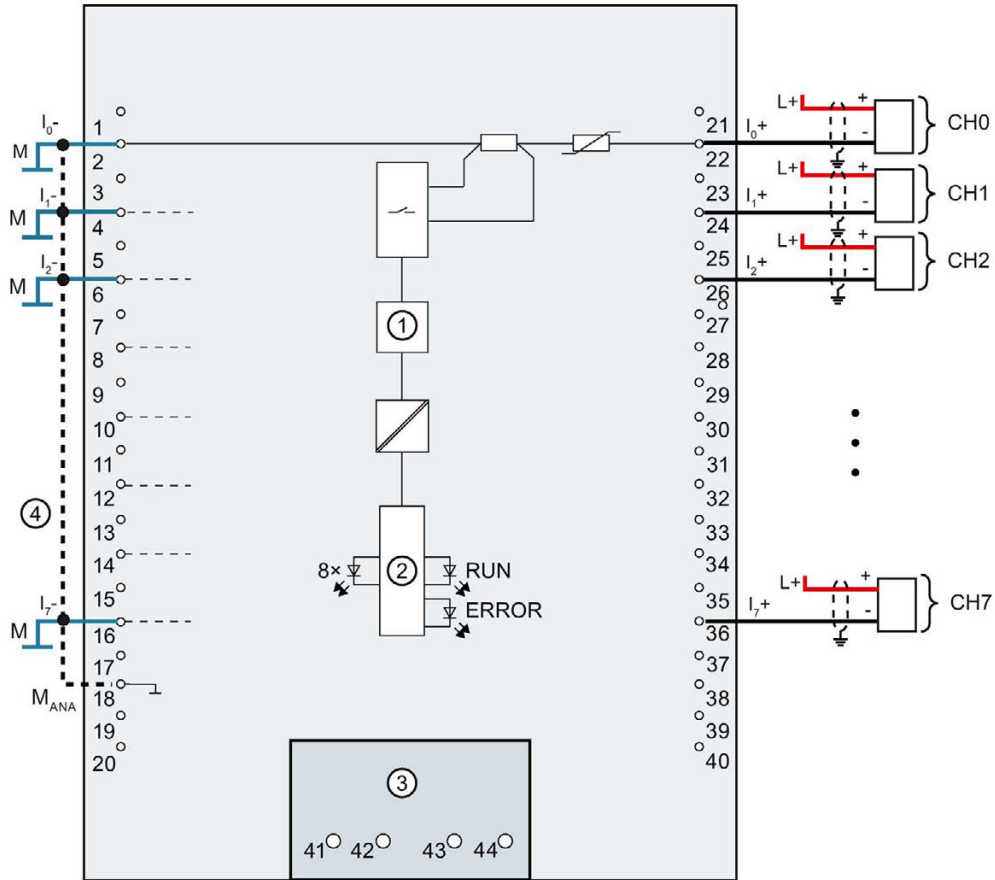

Figure 3-3 Block diagram and pin assignment for current measurement

Connection: 2-wire transmitters for current measurement

The example in the following figure shows the pin assignment for current measurement with 2-wire transmitters.



- | | | |
|--|-------|---|
| ① Analog-to-digital converter (ADC) | CHx | Channel or 8 x channel status (green/red) |
| ② Backplane bus interface | RUN | Status display LED (green) |
| ③ Infeed element (for shielding only) | ERROR | Error display LED (red) |
| ④ Equipotential bonding cable (optional) | | |

Figure 3-4 Block diagram and pin assignment for current measurement

Connection: 2-wire and 3-wire connection of resistance sensors or resistance thermometers (RTD)

The example in the following figure shows the pin assignment for 2-wire and 3-wire connections of resistance sensors or resistance thermometers.

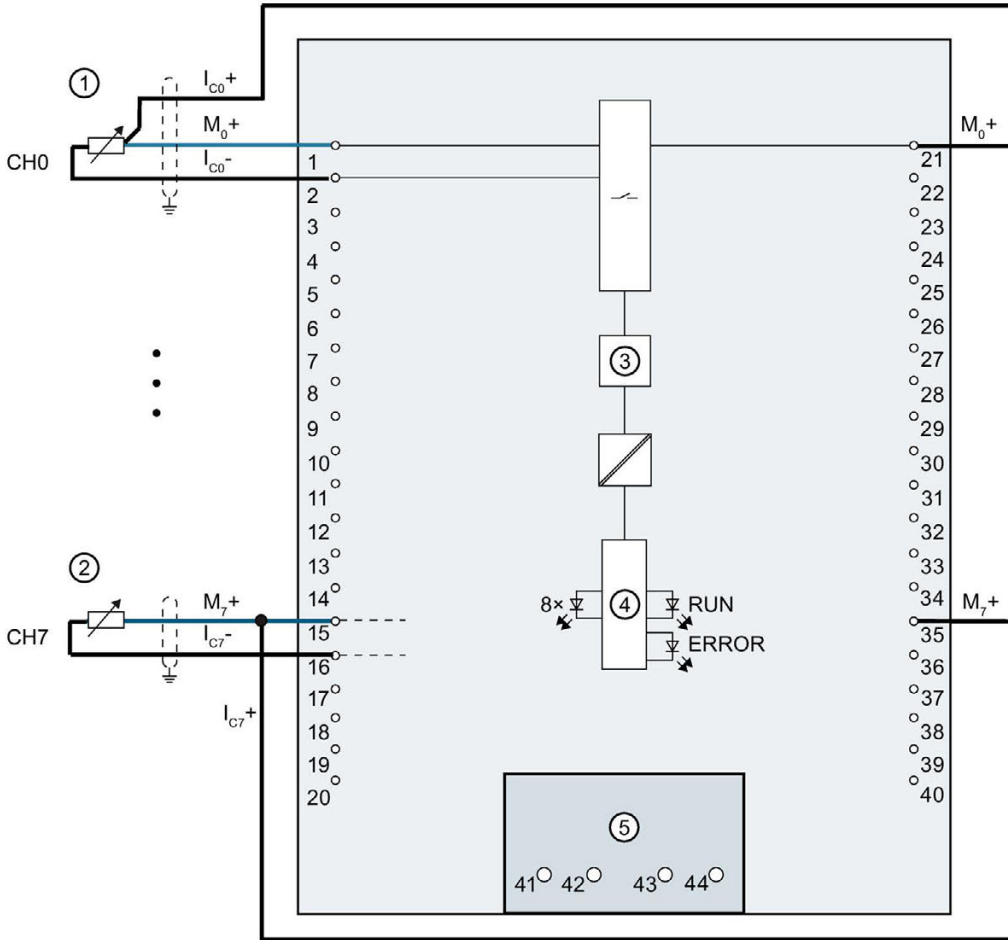

- | | | |
|---------------------------------------|-------|---|
| ① 3-wire connection | CHx | Channel or 8 x channel status (green/red) |
| ② 2-wire connection | RUN | Status display LED (green) |
| ③ Analog-to-digital converter (ADC) | ERROR | Error display LED (red) |
| ④ Backplane bus interface | | |
| ⑤ Infeed element (for shielding only) | | |

Figure 3-5 Block diagram and pin assignment for 2-wire, 3-wire connection

Parameters/address space

4.1 Measuring types and ranges

Introduction

The module is set to voltage measurement type with measuring range ± 10 V by default. You need to reassign the module parameters with STEP 7 if you want to use a different measurement type or range.

Deactivate the input if it is not going to be used. The module cycle time is shortened and the interference factors that lead to failure of the module (for example, triggering a hardware interrupt) are avoided.

The following table shows the measurement types and the respective measuring range.

Table 4- 1 Measurement types and measuring ranges

Measurement type	Measuring range	Representation of analog values
Voltage	± 50 mV ± 500 mV ± 1 V 1 V to 5 V ± 5 V ± 10 V	See Representation of analog values in voltage measuring ranges (Page 54)
Current 2WMT (2-wire transmitter)	4 mA to 20 mA	See Representation of analog values in the current measuring ranges (Page 55)
Current 4WMT (4-wire transmitter)	0 mA to 20 mA 4 mA to 20 mA ± 20 mA	
Resistor (2-wire connection)	PTC	See Representation of the analog values of resistance-based sensors/resistance thermometers (Page 56)
Resistor (3-wire connection)	600 Ω 6000 Ω	
Thermal resistor RTD (3-wire connection)	PT100 Standard/Climate PT1000 Standard/Climate Ni100 Standard/Climate Ni1000 Standard/Climate LG-Ni1000 Standard/Climate	
Disabled	-	-

The tables of the input ranges, overflow, underrange, etc. are available in the appendix Representation of analog values (Page 52).

Note

Wire break in voltage measuring ranges

"Wire break" diagnosis can be configured for the "Voltage" measurement type with the "Measuring range 1 to 5 V". No "wire break" diagnostics is available for the other measuring ranges.

If there is a wire break for these measuring ranges, the channel supplies a random value as an input value. This random value can also lie within the valid value range.

Using PTC resistors

PTC resistors are suitable for temperature monitoring of electrical devices, such as motors, drives, and transformers.

Use Type A PTC resistors (PTC thermistor) in accordance with DIN/VDE 0660, part 302. In doing so, follow these steps:

1. Choose "Resistor (2-wire terminal)" and "PTC" in STEP 7.
2. Connect the PTC using 2-wire connection technology.

If you enable the "Underflow" diagnostics in STEP 7, it will be signaled for resistance values <18 Ω. In this case, this diagnostic signifies "Short-circuit in the wiring".

The following figure shows the address space assignment for the AI 8xU/I/R/RTD BA module with PTC resistors.

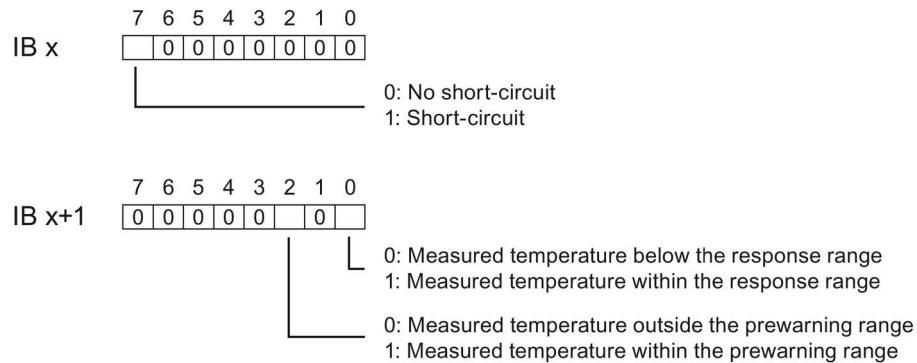

Figure 4-1 Address space for the AI 8xU/I/R/RTD BA module with PTC resistors

The diagram below shows the temperature profile and the corresponding switching points.

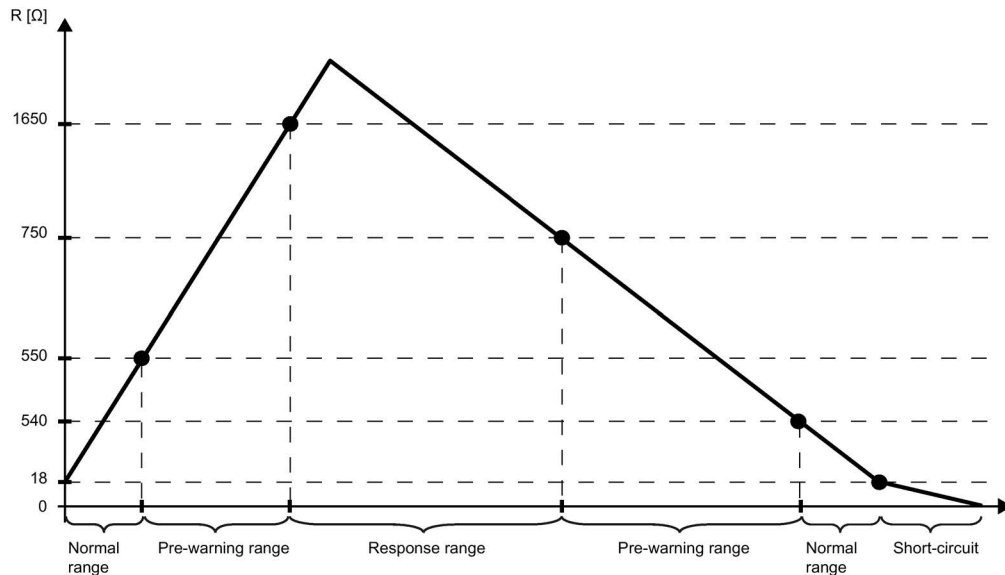

Figure 4-2 Temperature profile and the corresponding switching points

4.2 Parameters

Parameters of AI 8xU/I/R/RTD BA

When you assign the module parameters in STEP 7, you use various parameters to specify the module properties. The following table lists the configurable parameters. The effective range of the configurable parameters depends on the type of configuration. The following configurations are possible:

- Central operation with a S7-1500 CPU
- Distributed operation on PROFINET IO in an ET 200MP system
- Distributed operation on PROFIBUS DP in an ET 200MP system

When assigning parameters in the user program, use the WRREC instruction to transfer the parameters to the module by means of data records; refer to the section Parameter assignment and structure of the parameter data records (Page 45).

The following parameter settings for the channels are possible:

Table 4- 2 Configurable parameters and their defaults

Parameters	Range of values	Default setting	Parameter assignment in RUN	Scope with configuration software, e.g., STEP 7 (TIA Portal)	
				GSD file PROFINET IO	GSD file PROFIBUS DP
Diagnostics					
• Overflow	Yes/No	No	Yes	Channel	Module ²⁾
• Underflow	Yes/No	No	Yes	Channel	Module ²⁾
• Common mode error	Yes/No	No	Yes	Channel	Module ²⁾
• Wire break ¹⁾	Yes/No	No	Yes	Channel	Module ²⁾
Measuring					
• Measuring type	See chapter Measuring types and ranges (Page 18)	Voltage	Yes	Channel	Channel
• Measuring range		±10 V	Yes	Channel	Channel
• Temperature coefficient	Pt: 0.003851 Pt: 0.003902 Pt: 0.003916 Pt: 0.003920 Ni: 0.00618 Ni: 0.00672 LG-Ni: 0.005000	0.003851	Yes	Channel	Channel
• Temperature unit	• Kelvin (K) • Fahrenheit (°F) • Celsius (°C)	°C	Yes	Channel	Module
• Interference frequency suppression	400 Hz 60 Hz 50 Hz 10 Hz	50 Hz	Yes	Channel	Module
• Smoothing	None/low/medium/high	None	Yes	Channel	Channel

4.2 Parameters

Parameters	Range of values	Default setting	Parameter assignment in RUN	Scope with configuration software, e.g., STEP 7 (TIA Portal)	
				GSD file PROFINET IO	GSD file PROFIBUS DP
Hardware interrupts					
• Hardware interrupt low limit 1	Yes/No	No	Yes	Channel	--- ³⁾
• Hardware interrupt high limit 1	Yes/No	No	Yes	Channel	--- ³⁾
• Hardware interrupt low limit 2	Yes/No	No	Yes	Channel	--- ³⁾
• Hardware interrupt high limit 2	Yes/No	No	Yes	Channel	--- ³⁾

1) If "Wire break" diagnostics and "Value status" are deactivated, the module reports overflow / underflow (7FFF_H / 8000_H) in the event of a wiring error. The alarm depends on whether the connected cables are faulty.

Recommendation: Activate the "Wire break" diagnostics to obtain the correct value.

2) You can set the effective range of the diagnostics for each channel in the user program with data records 0 to 7.

3) You can configure the limits for hardware interrupts in the user program with data records 0 to 7.

4.3 Declaration of parameters

Overflow

Enabling of the diagnostics if the measured value violates the high limit.

Underflow

Enabling of the diagnostics when the measured value violates the low limit.

Common mode error

Enabling of diagnostics if the valid common mode voltage is exceeded.

Wire break

Enabling of the diagnostics if the module has no current flow or the current is too weak for the measurement at the corresponding configured input or the applied voltage is too low.

Temperature coefficient

The temperature coefficient depends on the chemical composition of the material. In Europe, only one value is used per sensor type (default value).

The temperature coefficient (α value) indicates by how much the resistance of a specific material changes relatively if the temperature increases by 1 °C.

The further values facilitate a sensor-specific setting of the temperature coefficient and enhance accuracy.

Interference frequency suppression

At analog input modules, this suppresses interference caused by the frequency of the AC network.

The frequency of the AC voltage network may interfere with measured values, particularly for measurements within narrow voltage ranges. For this parameter, the user defines the mains frequency prevailing on his system.

Smoothing

The individual measured values are smoothed using filtering. The smoothing can be set in 4 levels.

Smoothing time = number of module cycles (k) x cycle time of the module.

4.3 Declaration of parameters

The following figure shows the number of module cycles after which the smoothed analog value is almost 100%, depending on the set smoothing. It is valid for each signal change at the analog input.

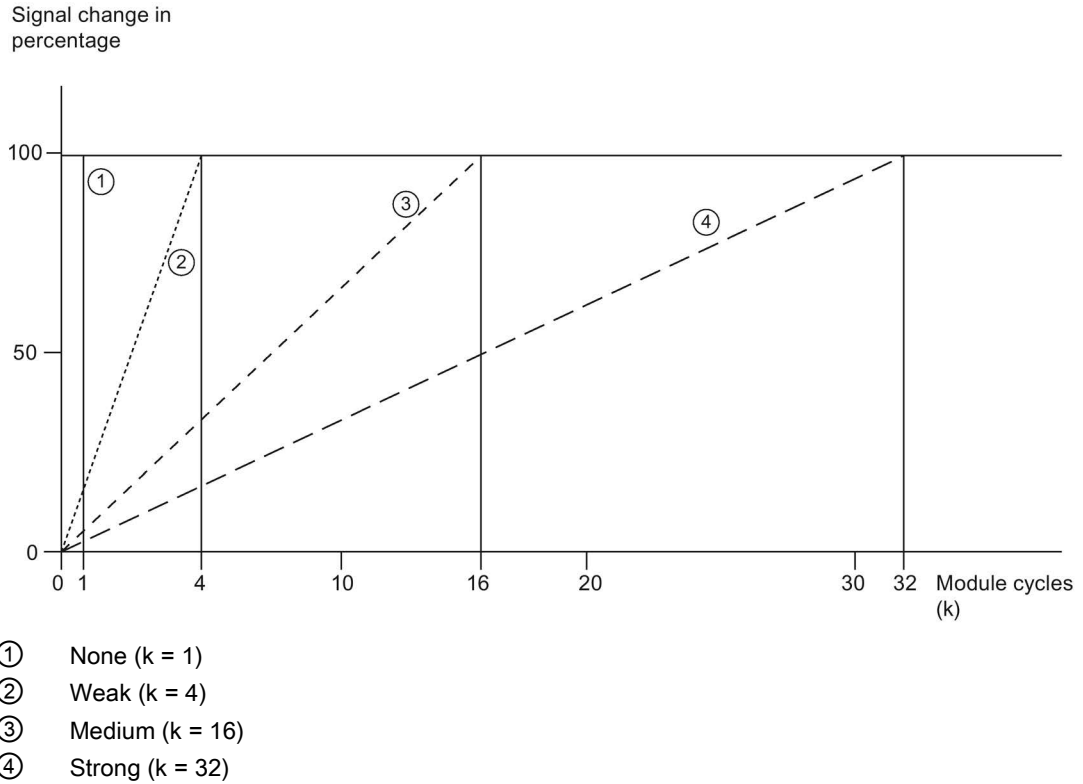

Figure 4-3 Smoothing for AI 8xU/I/R/RTD BA

Hardware interrupt 1 or 2

Enabling of a hardware interrupt at violation of high limit 1 or 2 or low limit 1 or 2.

Low limit 1 or 2

Specifies the low limit threshold that triggers hardware interrupt 1 or 2.

High limit 1 or 2

Specifies the high limit threshold that triggers hardware interrupt 1 or 2.

4.4 Address space

The module can be configured differently in STEP 7; see following table. Depending on the configuration, additional/different addresses are assigned in the process image of the inputs.

Configuration options of AI 8xU//R/RTD BA

You can configure the module with STEP 7 (TIA Portal) or with a GSD file.

When you configure the module by means of the GSD file, the configurations are available under different abbreviations/module names.

The following configurations are possible:

Table 4- 3 Configuration options

Configuration	Short designation/ module name in the GSD file	Configuration software, e.g., with STEP 7 (TIA Portal)	
		Integrate in the hardware catalog STEP 7 (TIA Portal) as of V15.1 and HSP 0275 or V16	GSD file in STEP 7 (TIA Portal) V12 or higher or STEP 7 V5.5 SP3 or higher
1 x 8-channel without value status	AI 8xU//R/RTD BA	X	X
1 x 8-channel with value status	AI 8xU//R/RTD BA QI	X	X
8 x 1-channel without value status	AI 8xU//R/RTD BA S	X (PROFINET IO only)	X (PROFINET IO only)
8 x 1-channel with value status	AI 8xU//R/RTD BA S QI	X (PROFINET IO only)	X (PROFINET IO only)
1 x 8-channel with value status for module-internal shared input with up to 4 submodules	AI 8xU//R/RTD BA MSI	X (PROFINET IO only)	X (PROFINET IO only)

Value status (Quality Information, QI)

The value status is always activated for the following module names:

- AI 8xU//R/RTD BA QI
- AI 8xU//R/RTD BA S QI
- AI 8xU//R/RTD BA MSI

An additional bit is assigned to each channel for the value status. The value status bit indicates if the read in digital value is valid. (0 = value is incorrect).

Address space of AI 8xU/I/R/RTD BA

The following figure shows the address space allocation for the configuration as 8-channel module. You can freely assign the start address for the module. The addresses of the channels are derived from the start address.

"IB x" stands, for example, for the module start address input byte x.

Assignment in the process image input (PII)

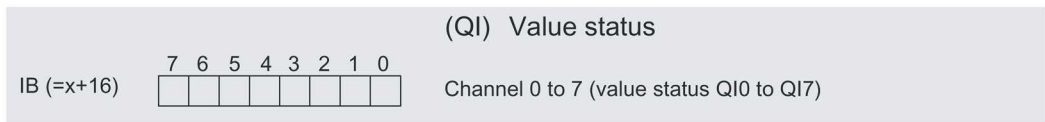
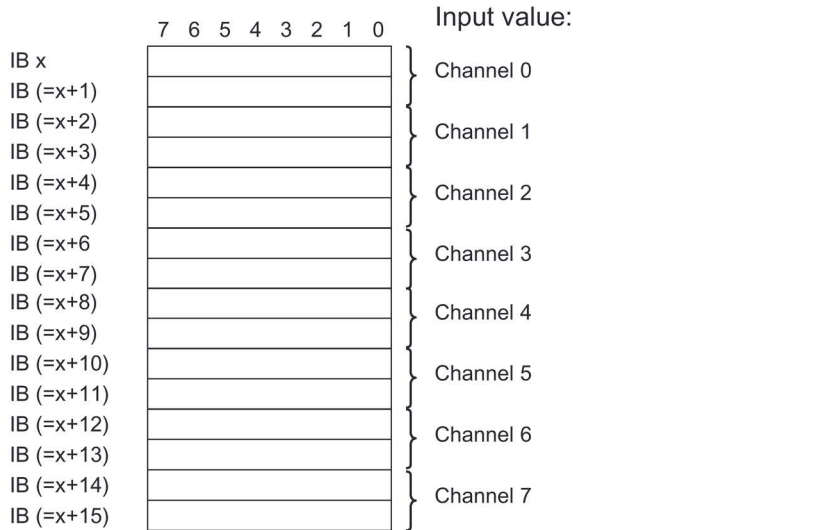

0= read in value at channel is incorrect

Figure 4-4 Address space for configuration as 1 x 8-channel AI 8xU/I/R/RTD BA with value status

Address space for configuration as 8 x 1-channel AI 8xU/I/R/RTD BA QI

For the configuration as a 8 x 1-channel module, the channels of the module are divided into multiple submodules. The submodules can be assigned to different IO controllers when the module is used in a shared device.

The number of usable IO controllers depends on the interface module used. Observe the information in the manual for the particular interface module.

Contrary to the 1 x 8-channel module configuration, each of the eight submodules has a freely assignable start address.

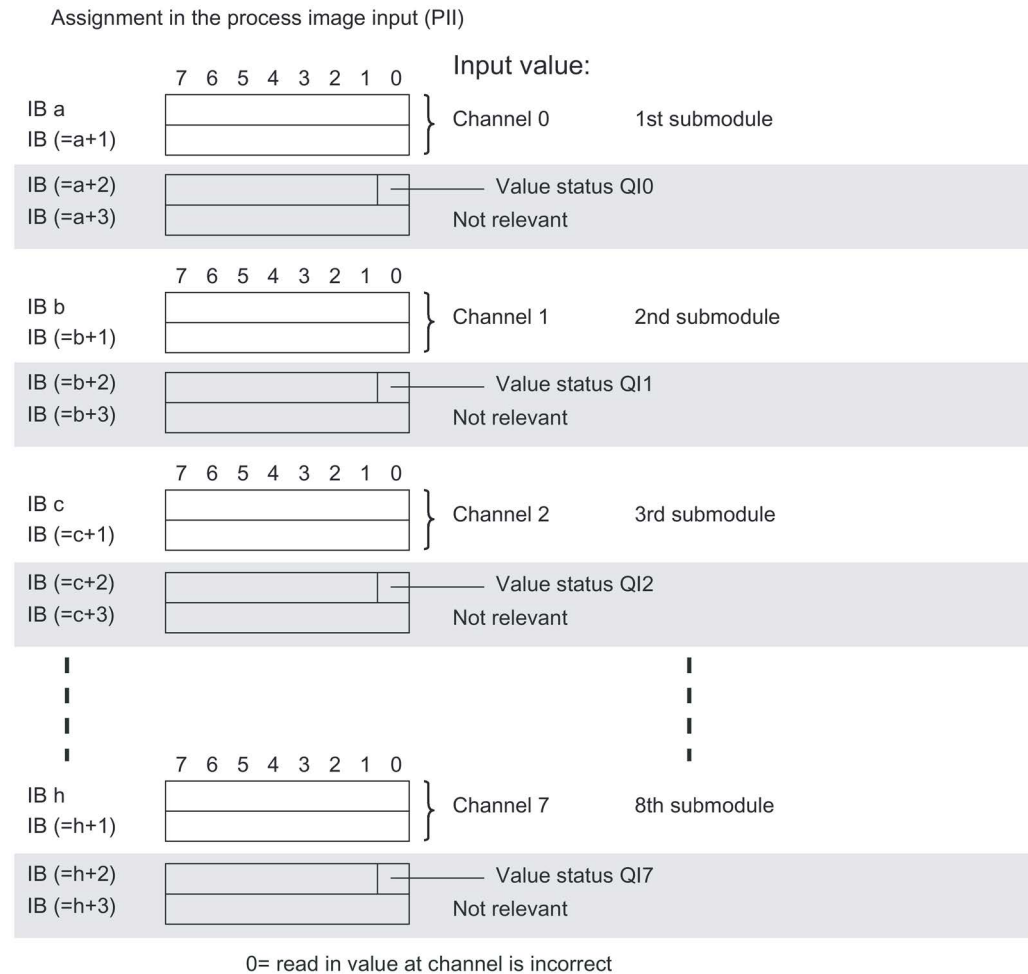

Figure 4-5 Address space for configuration as 8 x 1-channel AI 8xU/I/R/RTD BA S QI with value status

Address space for configuration as 1 x 8-channel AI 8xU/I/R/RTD BA MSI

The channels 0 to 7 of the module are copied in up to four submodules with configuration 1 x 8-channel module (Module-internal shared input, MSI). Channels 0 to 7 are then available with identical input values in different submodules. These submodules can be assigned to up to four IO controllers when the module is used in a shared device. Each IO controller has read access to the same channels.

The number of usable IO controllers depends on the interface module used. Please observe the information in the manual for the particular interface module.

Value status (Quality Information, QI)

The meaning of the value status depends on the submodule on which it occurs.

For the first submodule (=basic submodule), the value status 0 indicates that the value is incorrect.

For the 2nd to 4th submodule (=MSI submodule), the value status 0 indicates that the value is incorrect or the basic submodule has not yet been configured (not ready).

The figure below shows the assignment of the address space with submodules 1 and 2.

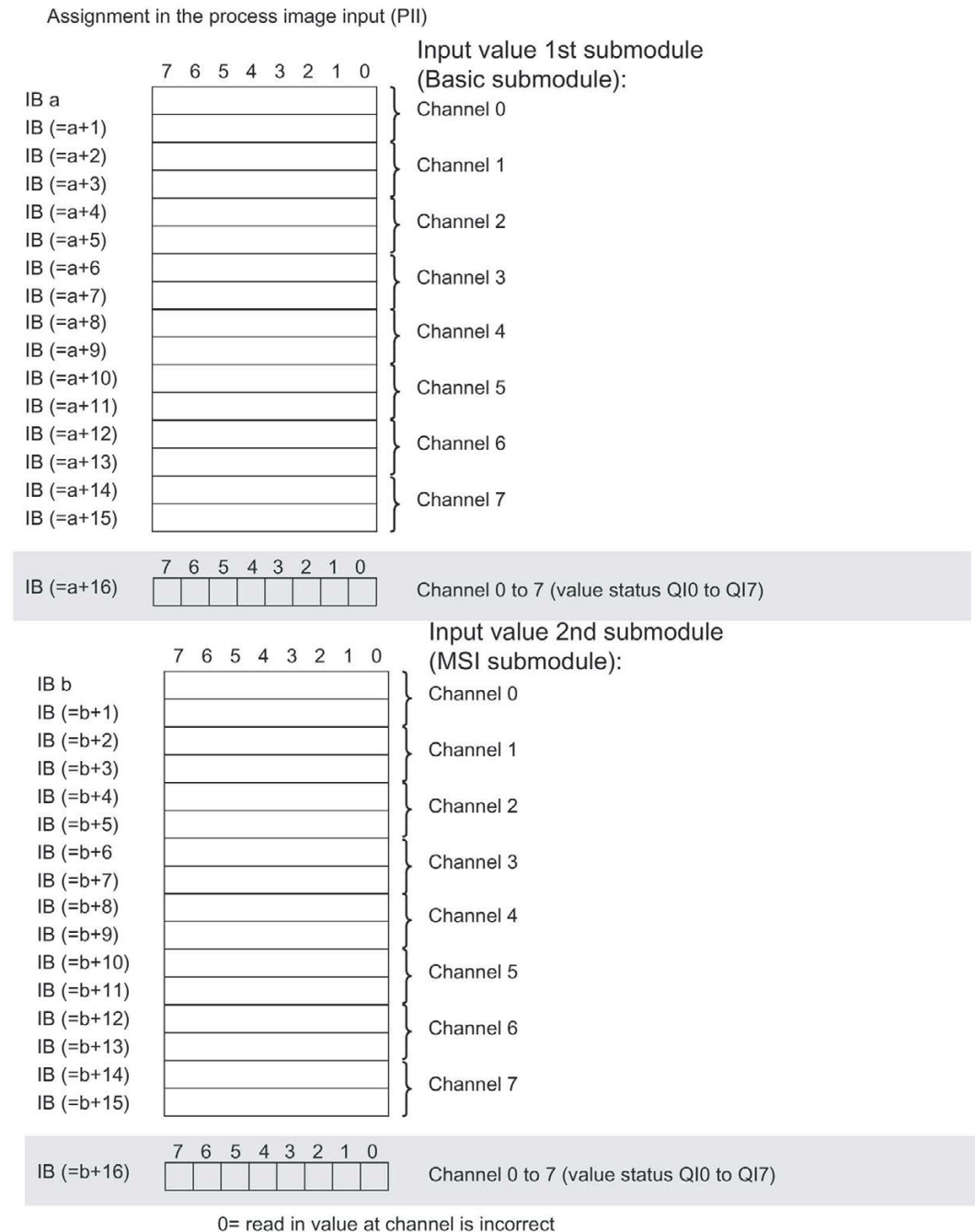

Figure 4-6 Address space for configuration as 1 x 8-channel AI 8xU/I/R/RTD BA MSI with value status

4.4 Address space

The following figure shows the assignment of the address space with submodule 3 and 4.

Assignment in the process image input (PII)

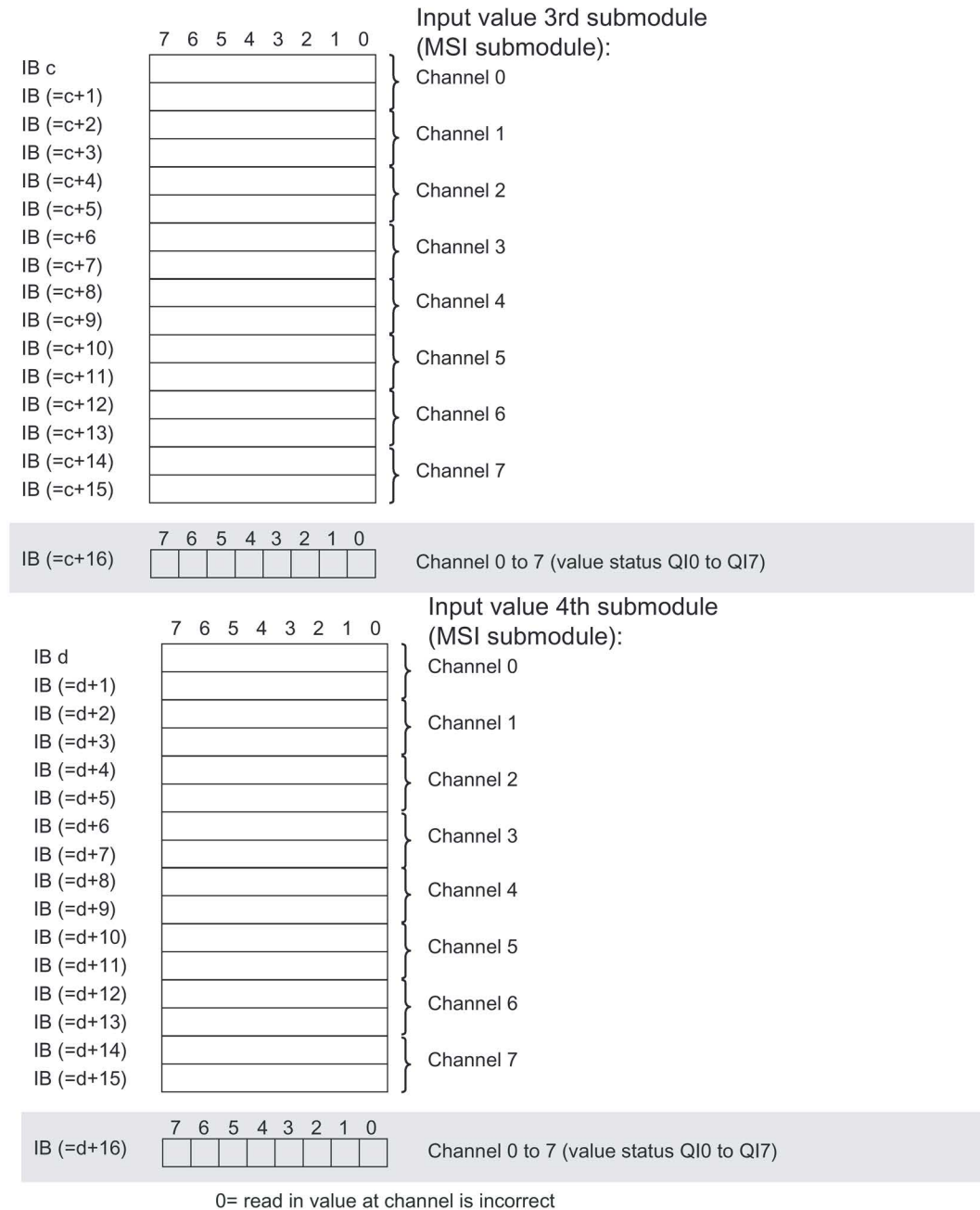

Figure 4-7 Address space for configuration as 1 x 8-channel AI 8xU/I/R/RTD BA MSI with value status

Reference

You can find information on the Shared Input/Output (MSI/MSO) function in the section Module-Internal Shared Input/Output (MSI/MSO) of the PROFINET with STEP 7 V15 (<https://support.industry.siemens.com/cs/ww/en/view/49948856>) function manual.

Interrupts/diagnostics alarms

5.1 Status and error displays

LED displays

The figure below shows the LED displays (status and error displays) of AI 8xU/I/R/RTD BA.

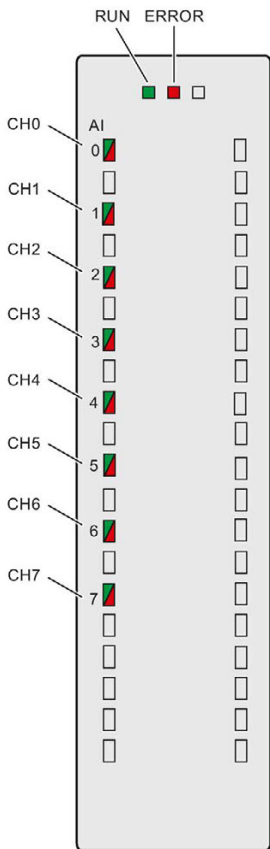











Figure 5-1 LED displays of the AI 8xU/I/R/RTD BA module

Meaning of the LED displays

The following tables explain the meaning of the status and error displays. Remedial measures for diagnostic alarms can be found in section Diagnostic alarms (Page 35).



RUN and ERROR LED

Table 5- 1 Status and error displays RUN and ERROR

LEDs		Meaning	Remedy
RUN	ERROR		
 Off	 Off	Voltage missing or too low at backplane bus.	<ul style="list-style-type: none"> Switch on the CPU and/or the system power supply modules. Verify that the U connectors are inserted. Check to see if too many modules are inserted.
 Flashes	 Off	The module starts and flashes until the valid parameter assignment is set.	---
 On	 Off	Module is configured.	
 On	 Flashes	Indicates module errors (at least one error at one channel, e.g., wire break).	Evaluate the diagnostics data and eliminate the error (e.g., wire break).
 Flashes	 Flashes	Hardware defective.	Replace the module.

CHx LED

Table 5- 2 CHx status display

LED CHx/COMP	Meaning	Remedy
 Off	Channel disabled	---
 On	Channel configured and OK.	---
 On	Channel is configured (channel error pending). Diagnostic alarm: e.g. wire break	Check the wiring. Disable diagnostics.

5.2 Interrupts

Analog input module AI 8xU/I/R/RTD BA supports the following diagnostic and hardware interrupts.

You can find detailed information on the event in the error organization block with the "RALRM" instruction (read additional interrupt info) and in the STEP 7 online help.

Diagnostic interrupt

The module generates a diagnostic interrupt at the following events:

- Wire break
- Overflow
- Underflow
- Common mode error
- Parameter assignment error

Hardware interrupt

The module generates a hardware interrupt at the following events:

- Low limit violated 1
- High limit violated 1
- Low limit violated 2
- Above high limit 2

The module channel that triggered the hardware interrupt is entered in the start information of the organization block. The diagram below shows the assignment to the bits of double word 8 in local data.

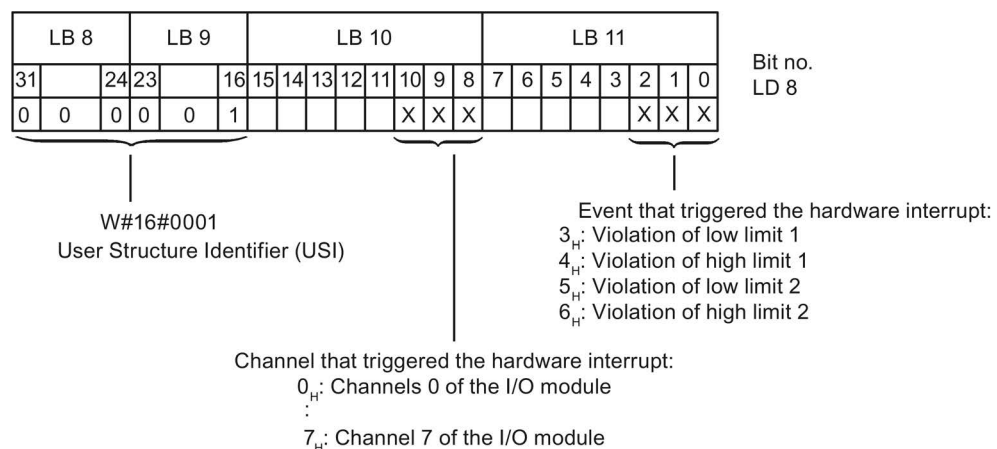

Figure 5-2 OB start information

5.2 Interrupts

Reaction when reaching limits 1 and 2 at the same time

If the two high limits 1 and 2 are reached at the same time, the module always signals the hardware interrupt for high limit 1 first. The configured value for high limit 2 is irrelevant. After processing the hardware interrupt for high limit 1, the module triggers the hardware interrupt for high limit 2.

The module has the same reaction when the low limits are reached at the same time. If the two low limits 1 and 2 are reached at the same time, the module always signals the hardware interrupt for low limit 1 first. After processing the hardware interrupt for low limit 1, the module triggers the hardware interrupt for low limit 2.

Structure of the additional interrupt information

Table 5- 3 Structure of USI = W#16#0001

Data block name	Contents	Remark	Bytes
USI (User Structure Identifier)	W#16#0001	Additional interrupt info for hardware interrupts of the I/O module	2
The channel that triggered the hardware interrupt follows.			
Channel	B#16#00 to B#16#n	Number of the event-triggering channel (n = number of module channels -1)	1
The event that triggered the hardware interrupt follows.			
Event	B#16#03	Low limit violated 1	1
	B#16#04	High limit violated 1	
	B#16#05	Low limit violated 2	
	B#16#06	Violation of high limit 2	

5.3 Diagnostics alarms

A diagnostics alarm is generated and the ERROR LED flashes on the module for each diagnostics event. The diagnostics alarms can be read out in the diagnostics buffer of the CPU, for example. You can evaluate the error codes with the user program.

If the module is operated distributed with PROFIBUS DP in an ET 200MP system, you have the option to read out diagnostics data with the instruction RDREC or RD_REC using data record 0 and 1. The structure of the data records is available in the "Manual for interface module IM 155-5 DP ST (6ES7155-5BA00-0AB0)" on the Internet (<https://support.industry.siemens.com/cs/ww/en/view/78324181>).

Table 5- 4 Diagnostics alarms, their meaning and corrective measures

Diagnostics alarm	Error code	Meaning	Solution
Wire break	6 _H	Impedance of encoder circuit too high	Use a different encoder type or modify the wiring, for example, using cables with larger cross-section
		Wire break between the module and sensor	Connect the cable
		Channel not connected (open)	<ul style="list-style-type: none"> • Disable diagnostics • Connect the channel
Overflow	7 _H	Measuring range violated	Check the measuring range
Underflow	8 _H	Measuring range violated	Check the measuring range
Parameter assignment error	10 _H	<ul style="list-style-type: none"> • The module cannot evaluate parameters for the channel • Incorrect parameter assignment 	Correct the parameter assignment
Common mode error	118 _H	Valid common mode voltage exceeded	Check the wiring, e.g. sensor ground connections, use equipotential cables

Diagnostics alarms with value status (QI)

If you configure the module with value status (QI), the module always checks all errors even if the respective diagnostics is not enabled. But the module cancels the inspection as soon as it detects the first error, regardless if the respective diagnostics has been enabled or not. The result may be that enabled diagnostics may not be displayed.

Example: You have enabled "Underflow" diagnostics, but the module detects the "Wire break" diagnostics first and aborts after this error message. The "Underflow" diagnostics is not detected.

Recommendation: To ensure that all errors can be diagnosed reliably, select all check boxes under "Diagnostics".

Technical specifications

Technical specifications of AI 8xU/I/R/RTD BA

The following table shows the technical specifications as of 03/2019. You can find a data sheet including daily updated technical specifications on the Internet (<https://support.industry.siemens.com/cs/ww/en/pv/6ES7531-7QF00-0AB0/td?dl=en>).

Article number	6ES7531-7QF00-0AB0
General information	
Product type designation	AI 8xU/I/R/RTD BA
HW functional status	FS01
Firmware version	V1.0.0
<ul style="list-style-type: none"> FW update possible 	Yes
Product function	
<ul style="list-style-type: none"> I&M data 	Yes; I&M0 to I&M3
Engineering with	
<ul style="list-style-type: none"> STEP 7 TIA Portal configurable/integrated as of version 	V15.1 / V16
<ul style="list-style-type: none"> STEP 7 configurable/integrated as of version 	V5.5 SP3 / -
<ul style="list-style-type: none"> PROFIBUS as of GSD version/GSD revision 	V1.0 / V5.1
<ul style="list-style-type: none"> PROFINET as of GSD version/GSD revision 	V2.3 / -
Operating mode	
<ul style="list-style-type: none"> Oversampling 	No
<ul style="list-style-type: none"> MSI 	Yes
CiR – Configuration in RUN	
Reparameterization possible in RUN	Yes
Calibration possible in RUN	No
Power	
Power available from the backplane bus	0.85 W
Power loss	
Power loss, typ.	0.9 W

Article number	6ES7531-7QF00-0AB0
Analog inputs	
Number of analog inputs	8
• For current measurement	8
• For voltage measurement	8
• For resistance/resistance thermometer measurement	8
permissible input voltage for voltage input (destruction limit), max.	12 V; 12 V continuous, 30 V for max. 1 s
permissible input current for current input (destruction limit), max.	40 mA
Constant measurement current for resistance-type transmitter, typ.	230 ... 370 μ A
Technical unit for temperature measurement adjustable	Yes; °C/°F/K
Input ranges (rated values), voltages	
• 0 to +5 V	No
• 0 to +10 V	No
• 1 V to 5 V	Yes
• Input resistance (1 V to 5 V)	10 M Ω
• -1 V to +1 V	Yes
• Input resistance (-1 V to +1 V)	10 M Ω
• -10 V to +10 V	Yes
• Input resistance (-10 V to +10 V)	10 M Ω
• -2.5 V to +2.5 V	No
• -25 mV to +25 mV	No
• -250 mV to +250 mV	No
• -5 V to +5 V	Yes
• Input resistance (-5 V to +5 V)	10 M Ω
• -50 mV to +50 mV	Yes
• Input resistance (-50 mV to +50 mV)	10 M Ω
• -500 mV to +500 mV	Yes
• Input resistance (-500 mV to +500 mV)	10 M Ω
• -80 mV to +80 mV	No

Article number	6ES7531-7QF00-0AB0
Input ranges (rated values), currents	
• 0 to 10 mA	No
• 0 to 20 mA	Yes
• Input resistance (0 to 20 mA)	25 Ω; Plus approx. 42 ohms for overvoltage protection by PTC
• -20 mA to +20 mA	Yes
• Input resistance (-20 mA to +20 mA)	25 Ω; Plus approx. 42 ohms for overvoltage protection by PTC
• 4 mA to 20 mA	Yes
• Input resistance (4 mA to 20 mA)	25 Ω; Plus approx. 42 ohms for overvoltage protection by PTC
Input ranges (rated values), thermocouples	
• Type B	No
• Type C	No
• Type E	No
• Type J	No
• Type K	No
• Type L	No
• Type N	No
• Type R	No
• Type S	No
• Type T	No
• Type U	No
• Type TXK/TXK(L) to GOST	No
Input ranges (rated values), resistance thermometer	
• Cu 10	No
• Cu 10 according to GOST	No
• Cu 50	No
• Cu 50 according to GOST	No
• Cu 100	No
• Cu 100 according to GOST	No
• Ni 10	No
• Ni 10 according to GOST	No
• Ni 100	Yes; Standard/climate
• Input resistance (Ni 100)	10 MΩ
• Ni 100 according to GOST	No

Article number	6ES7531-7QF00-0AB0
• Ni 1000	Yes; Standard/climate
• Input resistance (Ni 1000)	10 MΩ
• Ni 1000 according to GOST	No
• LG-Ni 1000	Yes; Standard/climate
• Input resistance (LG-Ni 1000)	10 MΩ
• Ni 120	No
• Ni 120 according to GOST	No
• Ni 200	No
• Ni 200 according to GOST	No
• Ni 500	No
• Ni 500 according to GOST	No
• Pt 10	No
• Pt 10 according to GOST	No
• Pt 50	No
• Pt 50 according to GOST	No
• Pt 100	Yes; Standard/climate
• Input resistance (Pt 100)	10 MΩ
• Pt 100 according to GOST	No
• Pt 1000	Yes; Standard/climate
• Input resistance (Pt 1000)	10 MΩ
• Pt 1000 according to GOST	No
• Pt 200	No
• Pt 200 according to GOST	No
• Pt 500	No
• Pt 500 according to GOST	No
Input ranges (rated values), resistors	
• 0 to 150 ohms	No
• 0 to 300 ohms	No
• 0 to 600 ohms	Yes
• Input resistance (0 to 600 ohms)	10 MΩ
• 0 to 3000 ohms	No
• 0 to 6000 ohms	Yes
• Input resistance (0 to 6000 ohms)	10 MΩ
• PTC	Yes
• Input resistance (PTC)	10 MΩ

Article number	6ES7531-7QF00-0AB0
Cable length	
<ul style="list-style-type: none"> shielded, max. 	200 m; 50 m at 50 mV
Analog value generation for the inputs	
Measurement principle	integrating
Integration and conversion time/resolution per channel	
<ul style="list-style-type: none"> Resolution with overrange (bit including sign), max. 	16 bit
<ul style="list-style-type: none"> Integration time, parameterizable 	Yes
<ul style="list-style-type: none"> Integration time (ms) 	2,5 / 16,67 / 20 / 100 ms
<ul style="list-style-type: none"> Basic conversion time, including integration time (ms) 	10 / 24 / 27 / 107 ms
<ul style="list-style-type: none"> <ul style="list-style-type: none"> additional conversion time for wire-break monitoring 	4 ms (to be considered in R/RTD/U 1 to 5 V measurement)
<ul style="list-style-type: none"> <ul style="list-style-type: none"> additional conversion time for resistance measurement 	8 ms
<ul style="list-style-type: none"> Interference voltage suppression for interference frequency f1 in Hz 	400 / 60 / 50 / 10 Hz
Smoothing of measured values	
<ul style="list-style-type: none"> parameterizable 	Yes
<ul style="list-style-type: none"> Step: None 	Yes
<ul style="list-style-type: none"> Step: low 	Yes
<ul style="list-style-type: none"> Step: Medium 	Yes
<ul style="list-style-type: none"> Step: High 	Yes
Encoder	
Connection of signal encoders	
<ul style="list-style-type: none"> for voltage measurement 	Yes
<ul style="list-style-type: none"> for current measurement as 2-wire transducer 	Yes; with external supply
<ul style="list-style-type: none"> for current measurement as 4-wire transducer 	Yes
<ul style="list-style-type: none"> for resistance measurement with two-wire connection 	Yes; Only for PTC
<ul style="list-style-type: none"> for resistance measurement with three-wire connection 	Yes; All measuring ranges except PTC; internal compensation of the cable resistances

Article number	6ES7531-7QF00-0AB0
Errors/accuracies	
Linearity error (relative to input range), (+/-)	0.1 %
Temperature error (relative to input range), (+/-)	0.006 %/K
Crosstalk between the inputs, max.	-50 dB
Repeat accuracy in steady state at 25 °C (relative to input range), (+/-)	0.1 %
Operational error limit in overall temperature range	
<ul style="list-style-type: none"> Voltage, relative to input range, (+/-) Current, relative to input range, (+/-) Resistance, relative to input range, (+/-) Resistance thermometer, relative to input range, (+/-) 	0.5 % 0.5 % 0.5 % Ptxxx Standard: ±1.2 K, Ptxxx Climate: ±0.8 K, Nixxx Standard: ±0.8 K, Nixxx Climate: ±0.8 K
Basic error limit (operational limit at 25 °C)	
<ul style="list-style-type: none"> Voltage, relative to input range, (+/-) Current, relative to input range, (+/-) Resistance, relative to input range, (+/-) Resistance thermometer, relative to input range, (+/-) 	0.3 % 0.3 % 0.3 % Ptxxx Standard: ±1.0 K, Ptxxx Climate: ±0.5 K, Nixxx Standard: ±0.5 K, Nixxx Climate: ±0.5 K
Interference voltage suppression for $f = n \times (f_1 \pm 1 \%)$, $f_1 =$ interference frequency	
<ul style="list-style-type: none"> Series mode interference (peak value of interference < rated value of input range), min. Common mode voltage, max. Common mode interference, min. 	40 dB 4 V 60 dB
Interrupts/diagnostics/status information	
Diagnostics function	Yes
Alarms	
<ul style="list-style-type: none"> Diagnostic alarm Limit value alarm 	Yes Yes; two upper and two lower limit values in each case
Diagnostic messages	
<ul style="list-style-type: none"> Monitoring the supply voltage Wire-break Short-circuit Group error Overflow/underflow 	No Yes; Only for 1 ... 5 V, 4 ... 20 mA, R, and RTD No No Yes

Article number	6ES7531-7QF00-0AB0
Diagnostics indication LED	
<ul style="list-style-type: none"> • RUN LED • ERROR LED • MAINT LED • Monitoring of the supply voltage (PWR-LED) • Channel status display • for channel diagnostics • for module diagnostics 	<p>Yes; Green LED</p> <p>Yes; Red LED</p> <p>No</p> <p>No</p> <p>Yes; Green LED</p> <p>Yes; Red LED</p> <p>Yes; Red LED</p>
Potential separation	
Potential separation channels	
<ul style="list-style-type: none"> • between the channels • between the channels, in groups of • between the channels and backplane bus 	<p>No</p> <p>8</p> <p>Yes</p>
Permissible potential difference	
between the inputs (UCM)	8 V DC
Between the inputs and MANA (UCM)	4 V DC
Isolation	
Isolation tested with	707 V DC (type test)
Ambient conditions	
Ambient temperature during operation	
<ul style="list-style-type: none"> • horizontal installation, min. • horizontal installation, max. • vertical installation, min. • vertical installation, max. 	<p>0 °C</p> <p>60 °C</p> <p>0 °C</p> <p>40 °C</p>
Decentralized operation	
Prioritized startup	No
Dimensions	
Width	35 mm
Height	147 mm
Depth	129 mm
Weights	
Weight, approx.	250 g

Additional information

You can learn how to calculate the cycle time of the module with an example provided on the Internet (<https://support.industry.siemens.com/cs/ww/en/view109761283>).

Dimensional drawing

A

The dimensional drawing of the module on the mounting rail, as well as a dimensional drawing with open front panel are provided in the appendix. Always adhere to the specified dimensions for installations in cabinets, control rooms, etc.

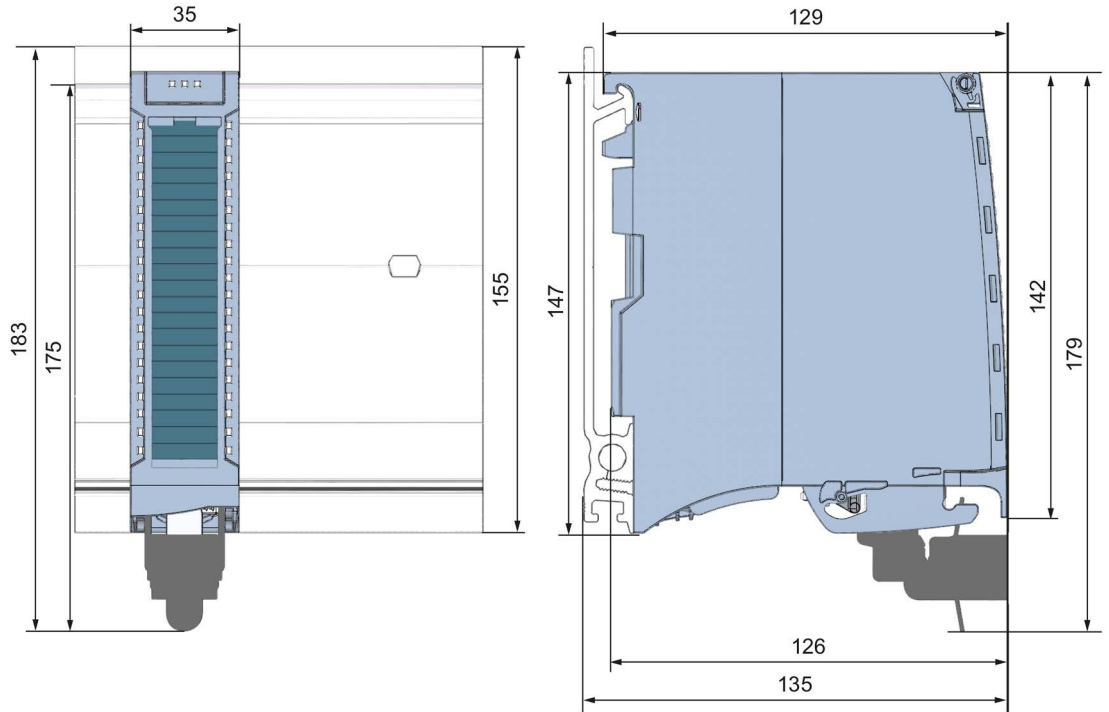

Figure A-1 Dimensional drawing of the AI 8xU//R/RTD BA module



Figure A-2 Dimension drawing of the AI 8xU/I/R/RTD BA module, side view with open front cover

Parameter data records

B.1 Parameter assignment and structure of the parameter data records

The data records of the module have an identical structure, regardless of whether you configure the module with PROFIBUS DP or PROFINET IO.

Dependencies for configuration with GSD file

When configuring the module with a GSD file, remember that the settings of some parameters are dependent on each other. The parameters are only checked for plausibility by the module after the transfer to the module.

The following table lists the parameters that depend on one another.

Table B- 1 Dependencies of parameters for configuration with GSD file

Device-specific parameters (GSD file)	Dependent parameters
Wire break	Only for measurement type resistance 3-wire connection, thermal resistor RTD, voltage with measuring range 1 to 5 V and current with measuring range 4 to 20 mA.
Common mode error	Only with measurement type voltage and current
Measurement type resistance (3-wire-connection)	Only with measuring range 600 Ω and 6000 Ω.
Hardware interrupt limits	Only if hardware interrupts are enabled.
Temperature unit Kelvin (K)	Only with measurement type thermal resistor (RTD) standard.

Parameter assignment in the user program

The module parameters can be assigned in RUN (for example, measuring ranges of selected channels can be edited in RUN without having an effect on the other channels).

Parameter assignment in RUN

The WRREC instruction is used to transfer the parameters to the module using data records 0 to 7. The parameters set in STEP 7 do not change in the CPU, which means the parameters set in STEP 7 are still valid after a restart.

The parameters are only checked for plausibility by the module after the transfer to the module.

Output parameter STATUS

The module ignores errors that occurred during the transfer of parameters with the WRREC instruction and continues operation with the previous parameter assignment. However, a corresponding error code is written to the STATUS output parameter.

The description of the WRREC instruction and the error codes is available in the STEP 7 online help.

Operation of the module behind a PROFIBUS DP interface module

If the module is operated behind a PROFIBUS DP interface module, the parameter data records 0 and 1 are not read back. You obtain the diagnostics data records 0 and 1 with the read back parameter data records 0 and 1. You can find additional information in the Interrupts section of the manual for the PROFIBUS DP interface module on the Internet (<http://support.automation.siemens.com/WW/view/en/78324181>).

Assignment of data record and channel

For the configuration as a 1 x 8-channel module, the parameters are located in data records 0 to 7 and are assigned as follows:

- Data record 0 for channel 0
- Data record 1 for channel 1
- ...
- Data record 6 for channel 6
- Data record 7 for channel 7

For configuration 8 x 1-channel, the module has 8 submodules with one channel each. The parameters for the channel are available in data record 0 and are assigned as follows:

- Data record 0 for channel 0 (submodule 1)
- Data record 0 for channel 1 (submodule 2)
- ...
- Data record 0 for channel 6 (submodule 7)
- Data record 0 for channel 7 (submodule 8)

Address the respective submodule for data record transfer.

Data record structure

The figure below shows the structure of data record 0 for channel 0 as an example. The structure is identical for channels 1 to 7. The values in byte 0 and byte 1 are fixed and may not be changed.

Enable a parameter by setting the corresponding bit to "1".

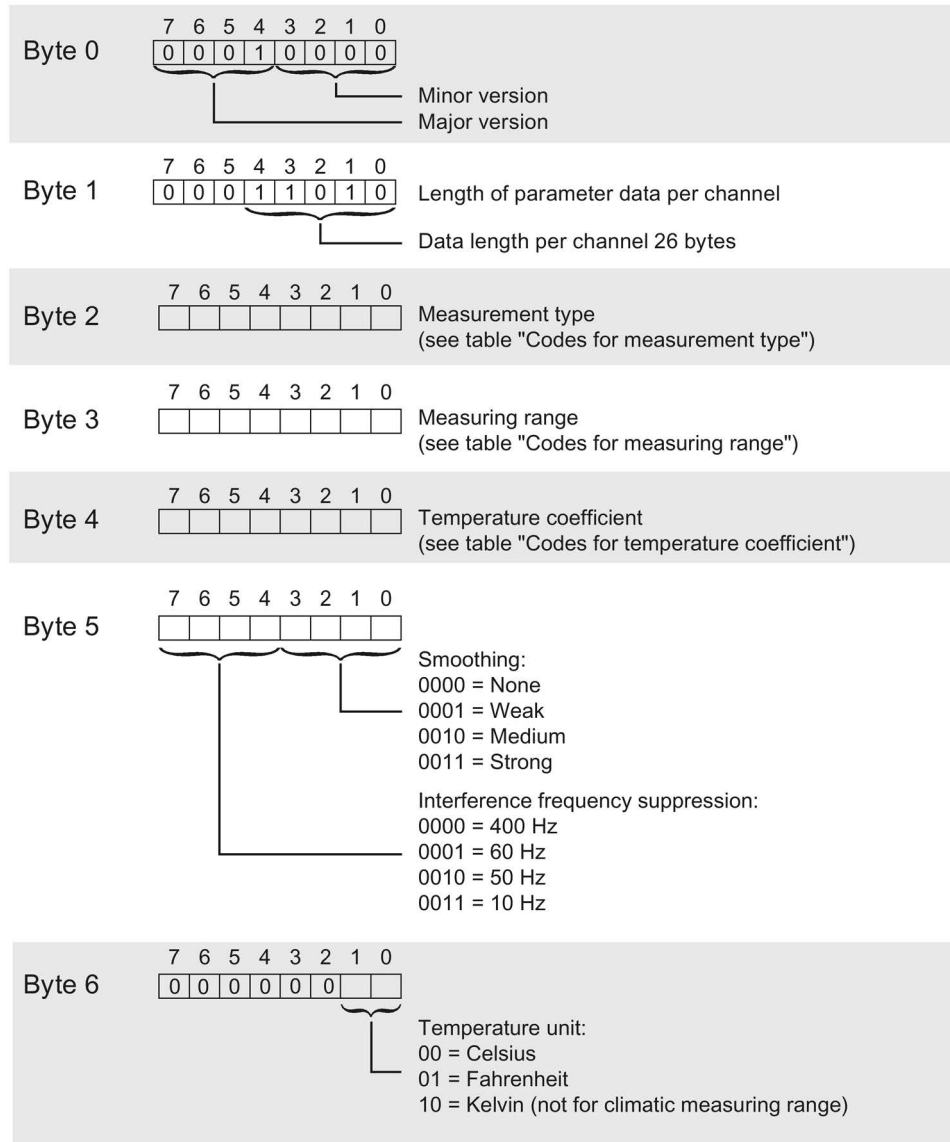
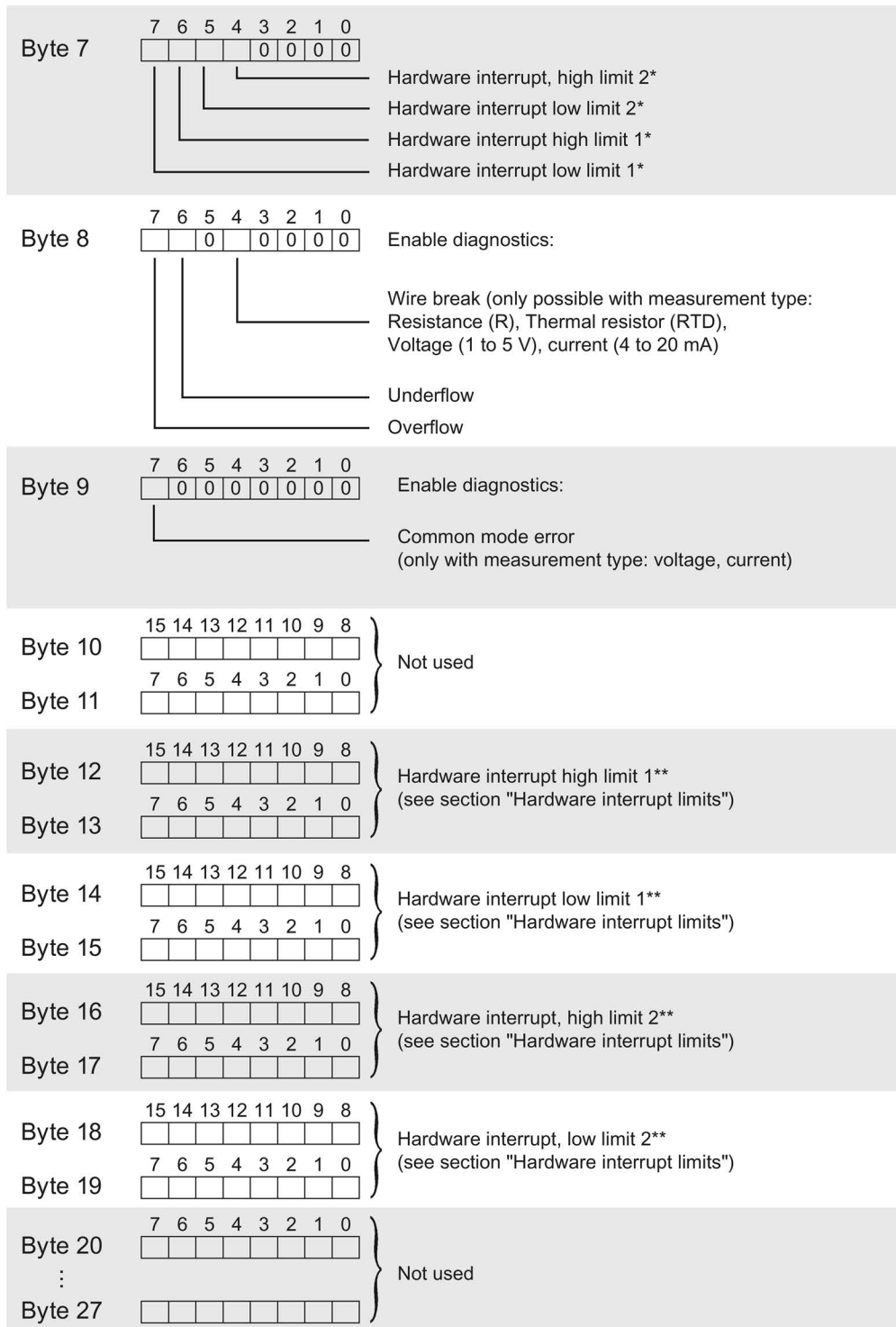

Figure B-1 Structure of data record 0: Bytes 0 to 6

B.1 Parameter assignment and structure of the parameter data records



* Hardware interrupts can only be activated via data record if the channel is assigned a hardware interrupt OB in STEP 7

** High limit must be greater than low limit

Figure B-2 Structure of data record 0: Bytes 7 to 27

Codes for measurement types

The following table lists all measurement types of the analog input module along with their codes. Enter these codes at byte 2 of the data record for the corresponding channel (see the figure Structure of data record 0: Bytes 7 to 27).

Table B- 2 Code for the measurement type

Measurement type	Code
Deactivated	0000 0000
Voltage	0000 0001
Current, 2-wire transmitter	0000 0011
Current, 4-wire transmitter	0000 0010
Resistance, 3-wire-connection *)	0000 0101
Resistance, 2-wire connection **)	0000 0110
Thermal resistor linear, 3-wire connection	0000 1000

*) Only for the following measuring ranges: 600 Ω , 6 k Ω

***) only for measuring range PTC

Codes for measuring ranges

The following table lists all measuring ranges of the analog input module along with their codes. Enter these codes accordingly at byte 3 of the data record for the corresponding channel (see the figure Structure of data record 0: Bytes 7 to 27).

Table B- 3 Code for the measuring range

Measuring range	Code
Voltage	
± 50 mV	0000 0001
± 500 mV	0000 0100
± 1 V	0000 0101
± 5 V	0000 1000
± 10 V	0000 1001
1 V to 5 V	0000 1010
Current, 4-wire transmitter	
0 mA to 20 mA	0000 0010
4 mA to 20 mA	0000 0011
± 20 mA	0000 0100

B.1 Parameter assignment and structure of the parameter data records

Current, 2-wire transmitter 4 mA to 20 mA	0000 0011
Resistor 600 Ω 6 kΩ PTC	0000 0011 0000 0101 0000 1111
Thermal resistor Pt100 Climate Ni100 Climate Pt100 standard Ni100 standard Pt1000 standard Ni1000 standard Pt1000 Climate Ni1000 Climate LG-Ni1000 standard LG-Ni1000 Climate	0000 0000 0000 0001 0000 0010 0000 0011 0000 0101 0000 0110 0000 1001 0000 1010 0001 1100 0001 1101

Codes for temperature coefficients

The following table lists all temperature coefficients along with their codes for temperature measurements with the thermal resistors. You need to enter these codes in byte 4 of the data records 0 to 6 (see Fig. Structure of data record 0: bytes 0 to 6).

Table B- 4 Codes for temperature coefficient

Temperature coefficient	Code
Pt xxx 0.003851 0.003916 0.003902 0.003920	0000 0000 0000 0001 0000 0010 0000 0011
Ni xxx 0.006180 0.006720	0000 1000 0000 1001
LG-Ni 0.005000	0000 1010

Hardware interrupt limits

The values that you can set for hardware interrupts (high/low limit) must not violate the over/underrange of the respective rated measuring range.

B.1 Parameter assignment and structure of the parameter data records

The following tables list the valid hardware interrupt limits. The limits depend on the selected measurement type and measuring range.

Table B- 5 Voltage limits

Voltage		
± 50 mV, ± 500 mV, ± 1 V, ± 5 V, ± 10 V	1 V to 5 V	
32510	32510	High limit
-32511	-4863	Low limit

Table B- 6 Current and resistance limits

Current		Resistor	
± 20 mA	4 mA to 20 mA / 0 mA to 20 mA	(all configurable measuring ranges)	
32510	32510	32510	High limit
-32511	-4863	1	Low limit

Table B- 7 Limits for thermal resistor Pt xxx Standard and Pt xxx Climatic

Thermal resistor						
Pt xxx Standard			Pt xxx Climate			
$^{\circ}\text{C}$	$^{\circ}\text{F}$	K	$^{\circ}\text{C}$	$^{\circ}\text{F}$	K	
9999	18319	12731	15499	31099	---	High limit
-2429	-4053	303	-14499	-22899	---	Low limit

Table B- 8 Limits for thermal resistor Ni xxx Standard and Ni xxx Climatic

Thermal resistor						
Ni xxx Standard			Ni xxx Climate			
$^{\circ}\text{C}$	$^{\circ}\text{F}$	K	$^{\circ}\text{C}$	$^{\circ}\text{F}$	K	
2949	5629	5681	15499	31099	---	High limit
-1049	-1569	1683	-10499	-15699	---	Low limit

Representation of analog values

Introduction

This appendix shows the analog values for all measuring ranges supported by the AI 8xU/I/R/RTD BA analog module.

Measured value resolution

Each analog value is written left aligned to the tags. The bits marked with "x" are set to "0".

Note

This resolution does not apply to temperature values. The digitalized temperature values are the result of a conversion in the analog module.

Table C- 1 Resolution of the analog values

Resolution in bits including sign	Values		Analog value	
	Decimal	Hexadecimal	High byte	Low byte
16	1	1H	Sign 0 0 0 0 0 0 0	0 0 0 0 0 0 0 1

C.1 Representation of input ranges

The following tables set out the digitalized representation of the input ranges by bipolar and unipolar range. The resolution is 16 bits.

Table C- 2 Bipolar input ranges

Dec. value	Measured value in %	Data word															Range	
		2 ¹⁵	2 ¹⁴	2 ¹³	2 ¹²	2 ¹¹	2 ¹⁰	2 ⁹	2 ⁸	2 ⁷	2 ⁶	2 ⁵	2 ⁴	2 ³	2 ²	2 ¹		2 ⁰
32767	>117.589	0	1	1	1	1	1	1	1	1	1	1	1	1	1	1	1	Overflow
32511	117.589	0	1	1	1	1	1	1	0	1	1	1	1	1	1	1	1	Overshoot range
27649	100.004	0	1	1	0	1	1	0	0	0	0	0	0	0	0	0	1	
27648	100.000	0	1	1	0	1	1	0	0	0	0	0	0	0	0	0	0	Rated range
1	0.003617	0	0	0	0	0	0	0	0	0	0	0	0	0	0	0	1	
0	0.000	0	0	0	0	0	0	0	0	0	0	0	0	0	0	0	0	
-1	-0.003617	1	1	1	1	1	1	1	1	1	1	1	1	1	1	1	1	
-27648	-100.000	1	0	0	1	0	1	0	0	0	0	0	0	0	0	0	0	Undershoot range
-27649	-100.004	1	0	0	1	0	0	1	1	1	1	1	1	1	1	1	1	
-32512	-117.593	1	0	0	0	0	0	0	1	0	0	0	0	0	0	0	0	Underflow
-32768	<-117.593	1	0	0	0	0	0	0	0	0	0	0	0	0	0	0	0	

Table C- 3 Unipolar input ranges

Dec. value	Measured value in %	Data word															Range	
		2 ¹⁵	2 ¹⁴	2 ¹³	2 ¹²	2 ¹¹	2 ¹⁰	2 ⁹	2 ⁸	2 ⁷	2 ⁶	2 ⁵	2 ⁴	2 ³	2 ²	2 ¹		2 ⁰
32767	>117.589	0	1	1	1	1	1	1	1	1	1	1	1	1	1	1	1	Overflow
32511	117.589	0	1	1	1	1	1	1	0	1	1	1	1	1	1	1	1	Overshoot range
27649	100.004	0	1	1	0	1	1	0	0	0	0	0	0	0	0	0	1	
27648	100.000	0	1	1	0	1	1	0	0	0	0	0	0	0	0	0	0	Rated range
1	0.003617	0	0	0	0	0	0	0	0	0	0	0	0	0	0	0	1	
0	0.000	0	0	0	0	0	0	0	0	0	0	0	0	0	0	0	0	
-1	-0.003617	1	1	1	1	1	1	1	1	1	1	1	1	1	1	1	1	
-4864	-17.593	1	1	1	0	1	1	0	1	0	0	0	0	0	0	0	0	Undershoot range
-32768	<-17.593	1	0	0	0	0	0	0	0	0	0	0	0	0	0	0	0	

C.2 Representation of analog values in voltage measuring ranges

The following tables list the decimal and hexadecimal values (codes) of the possible voltage measuring ranges.

Table C- 4 Voltage measuring ranges ± 10 V, ± 5 V, ± 1 V,

Values		Voltage measuring range			Range
dec	hex	± 10 V	± 5 V	± 1 V	
32767	7FFF	>11.759 V	>5.879 V	> 1.176 V	Overflow
32511	7EFF	11.759 V	5.879 V	1.176 V	Overshoot range
27649	6C01				
27648	6C00	10 V	5 V	1 V	Rated range
20736	5100	7.5 V	3.75 V	0.75 V	
1	1	361.7 μ V	180.8 μ V	36.17 μ V	
0	0	0 V	0 V	0 V	
-1	FFFF				
-20736	AF00	-7.5 V	-3.75 V	-0.75 V	
-27648	9400	-10 V	-5 V	-1 V	Undershoot range
-27649	93FF				
-32512	8100	-11.759 V	-5.879 V	-1.176 V	
-32768	8000	< -11.759 V	< -5.879 V	< -1.176 V	Underflow

Table C- 5 Voltage measuring ranges ± 500 mV and ± 50 mV

Values		Voltage measuring range		Range
dec	hex	± 500 mV	± 50 mV	
32767	7FFF	>587.9 mV	> 58.8 mV	Overflow
32511	7EFF	587.9 mV	58.8 mV	Overshoot range
27649	6C01			
27648	6C00	500 mV	50 mV	Rated range
20736	5100	375 mV	37.5 mA	
1	1	18.08 μ V	1.81 μ V	
0	0	0 mV	0 mV	
-1	FFFF			
-20736	AF00	-375 mV	-37.5 mV	
-27648	9400	-500 mV	-50 mV	Undershoot range
-27649	93FF			
-32512	8100	-587.9 mV	-58.8 mV	
-32768	8000	<-587.9 mV	< -58.8 mV	Underflow

C.3 Representation of analog values in the current measuring ranges

Table C- 6 Voltage measuring range 1 to 5 V

Values		Voltage measuring range	Range
dec	hex	1 to 5 V	
32767	7FFF	>5.704 V	Overflow
32511	7EFF	5.704 V	Overshoot range
27649	6C01		
27648	6C00	5 V	Rated range
20736	5100	4 V	
1	1	1 V + 144.7 μ V	
0	0	1 V	
-1	FFFF		
-4864	ED00	0.296 V	Undershoot range
-32768	8000	< 0.296 V	Underflow

C.3 Representation of analog values in the current measuring ranges

The following tables list the decimal and hexadecimal values (codes) of the possible current measuring ranges.

Table C- 7 Current measuring range ± 20 mA

Values		Current measuring range	
dec	hex	± 20 mA	
32767	7FFF	>23.52 mA	Overflow
32511	7EFF	23.52 mA	Overshoot range
27649	6C01		
27648	6C00	20 mA	Rated range
20736	5100	15 mA	
1	1	723.4 nA	
0	0	0 mA	
-1	FFFF		
-20736	AF00	-15 mA	Undershoot range
-27648	9400	-20 mA	
-27649	93FF		
-32512	8100	-23.52 mA	
-32768	8000	< -23.52 mA	

C.4 Representation of the analog values of resistance-based sensors/resistance thermometers

Table C- 8 Current measuring ranges 0 to 20 mA and 4 to 20 mA

Values		Current measuring range		
dec	hex	0 to 20 mA	4 to 20 mA	
32767	7FFF	>23.52 mA	>22.81 mA	Overflow
32511	7EFF	23.52 mA	22.81 mA	Overshoot range
27649	6C01			
27648	6C00	20 mA	20 mA	
20736	5100	15 mA	16 mA	Rated range
1	1	723.4 nA	4 mA + 578.7 nA	
0	0	0 mA	4 mA	
-1	FFFF			Undershoot range
-4864	ED00	-3.52 mA	1.185 mA	
-32768	8000	<- 3.52 mA	< 1.185 mA	Underflow

C.4 Representation of the analog values of resistance-based sensors/resistance thermometers

The following tables list the decimal and hexadecimal values (codes) of the possible resistance-based sensor ranges.

Table C- 9 Resistance sensors of 600 Ω and 6000 Ω

Values		Resistive transmitter range		
dec	hex	600 Ω	6000 Ω	
32767	7FFF	>705.53 Ω	>7055.3 Ω	Overflow
32511	7EFF	705.53 Ω	7055.3 Ω	Overshoot range
27649	6C01			
27648	6C00	600 Ω	6000 Ω	
20736	5100	450 Ω	4500 Ω	Rated range
1	1	21.70 mΩ	217 mΩ	
0	0	0 Ω	0 Ω	

C.4 Representation of the analog values of resistance-based sensors/resistance thermometers

The following tables list the decimal and hexadecimal values (codes) of the supported resistance thermometers.

Table C- 10 Resistance thermometers Pt 100 and Pt 1000 Standard

Pt x00 Standard in °C (1 digit = 0.1°C)	Values		Pt x00 Standard in °F (1 digit = 0.1 °F)	Values		Pt x00 Standard in K (1 digit = 0.1 K)	Values		Range
	dec	hex		dec	hex		dec	hex	
> 1000.0	32767	7FFF	> 1832.0	32767	7FFF	> 1273.2	32767	7FFF	Overflow
1000.0	10000	2710	1832.0	18320	4790	1273.2	12732	31BC	Overshoot range
:	:	:	:	:	:	:	:	:	
850.1	8501	2135	1562.1	15621	3D05	1123.3	11233	2BE1	
850.0	8500	2134	1562.0	15620	3D04	1123.2	11232	2BE0	Rated range
:	:	:	:	:	:	:	:	:	
-200.0	-2000	F830	-328.0	-3280	F330	73.2	732	2DC	
-200.1	-2001	F82F	-328.1	-3281	F32F	73.1	731	2DB	Undershoot range
:	:	:	:	:	:	:	:	:	
-243.0	-2430	F682	-405.4	-4054	F02A	30.2	302	12E	
< -243.0	-32768	8000	< -405.4	-32768	8000	< 30.2	32768	8000	Underflow

Table C- 11 Resistance thermometers Pt 100 and Pt 1000 Climate

Pt x00 Climate/ in °C (1 digit = 0.01 °C)	Values		Pt x00 Climate/ in °F (1 digit = 0.01 °F)	Values		Range
	dec	hex		dec	hex	
> 155.00	32767	7FFF	> 311.00	32767	7FFF	Overflow
155.00	15500	3C8C	311.00	31100	797C	Overshoot range
:	:	:	:	:	:	
130.01	13001	32C9	266.01	26601	67E9	
130.00	13000	32C8	266.00	26600	67E8	Rated range
:	:	:	:	:	:	
-120.00	-12000	D120	-184.00	-18400	B820	
-120.01	-12001	D11F	-184.01	-18401	B81F	Undershoot range
:	:	:	:	:	:	
-145.00	-14500	C75C	-229.00	-22900	A68C	
< -145.00	-32768	8000	< -229.00	-32768	8000	Underflow

Representation of analog values

C.4 Representation of the analog values of resistance-based sensors/resistance thermometers

Table C- 12 Thermal resistors Ni 100, Ni 1000, LG-Ni 1000 Standard

Ni x00 standard in °C (1 digit = 0.1 °C)	Values		Ni x00 Standard in °F (1 digit = 0.1 °F)	Values		Ni x00 Standard in K (1 digit = 0.1 K)	Values		Range
	dec	hex		dec	hex		dec	hex	
> 295.0	32767	7FFF	> 563.0	32767	7FFF	> 568.2	32767	7FFF	Overflow
295.0	2950	B86	563.0	5630	15FE	568.2	5682	1632	Overshoot range
:	:	:	:	:	:	:	:	:	
250.1	2501	9C5	482.1	4821	12D5	523.3	5233	1471	Rated range
250.0	2500	9C4	482.0	4820	12D4	523.2	5232	1470	
:	:	:	:	:	:	:	:	:	
-60.0	-600	FDA8	-76.0	-760	FD08	213.2	2132	854	Undershoot range
-60.1	-601	FDA7	-76.1	-761	FD07	213.1	2131	853	
:	:	:	:	:	:	:	:	:	
-105.0	-1050	FBE6	-157.0	-1570	F9DE	168.2	1682	692	Underflow
< -105.0	-32768	8000	< -157.0	-32768	8000	< 168.2	32768	8000	

Table C- 13 Thermal resistors Ni 100, Ni 1000, LG-Ni 1000 Climate

Ni x00 Climate in °C (1 digit = 0.01 °C)	Values		Ni x00 Climate in °F (1 digit = 0.01 °F)	Values		Range
	dec	hex		dec	hex	
> 155.00	32767	7FFF	> 311.00	32767	7FFF	Overflow
155.00	15500	3C8C	311.00	31100	797C	Overshoot range
:	:	:	:	:	:	
130.01	13001	32C9	266.01	26601	67E9	Rated range
130.00	13000	32C8	266.00	26600	67E8	
:	:	:	:	:	:	
-60.00	-6000	E890	-76.00	-7600	E250	Undershoot range
-60.01	-6001	E88F	-76.01	-7601	E24F	
:	:	:	:	:	:	
-105.00	-10500	D6FC	-157.00	-15700	C2AC	Underflow
< - 105.00	-32768	8000	< - 157.00	-32768	8000	

C.5 Measured values for wire break diagnostic

Measured values on diagnostic event "wire break", dependent on diagnostics enables

Error events initiate a diagnostics entry and trigger a diagnostics interrupt if configured accordingly.

Table C- 14 Measured values for wire break diagnostic

Format	Parameter assignment	Measured values		Explanation
S7	<ul style="list-style-type: none"> "Wire break" diagnostics enabled "Overflow/Underflow" diagnostics enabled or disabled ("Wire break" diagnostics takes priority over "Overflow/Underflow" diagnostics)	32767	7FFF _H	"Wire break" or "Open circuit" diagnostic alarm
	<ul style="list-style-type: none"> "Wire break" diagnostics disabled "Overflow/Underflow" diagnostics enabled 	-32767	8000 _H	<ul style="list-style-type: none"> Measured value after leaving the undershoot range Diagnostic alarm "Low limit violated"
	<ul style="list-style-type: none"> "Wire break" diagnostics disabled "Overflow/Underflow" diagnostics disabled 	-32767	8000 _H	Measured value after leaving the undershoot range