

SIEMENS

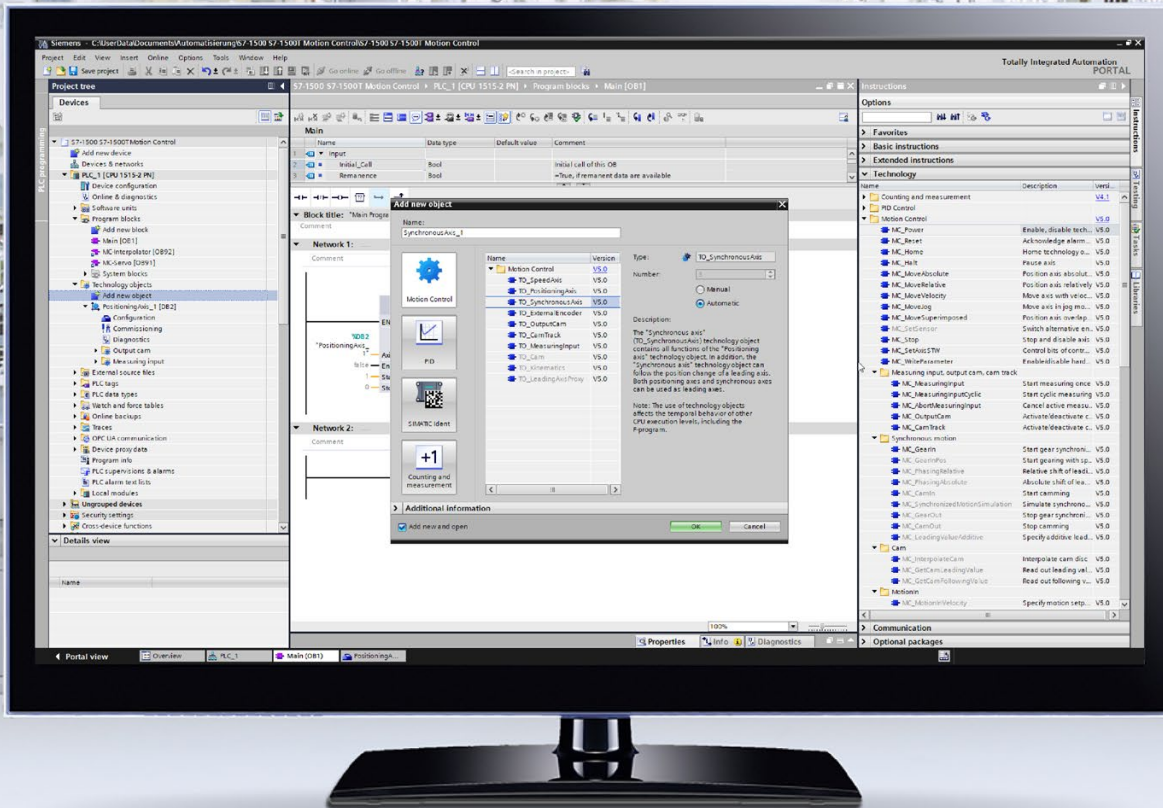

Function manual

SIMATIC

S7-1500/S7-1500T

S7-1500/S7-1500T Motion Control overview V5.0
in TIA Portal V16

Edition

12/2019

support.industry.siemens.com

SIMATIC

S7-1500 S7-1500/S7-1500T Motion Control overview V5.0 in TIA Portal V16

Function Manual

Preface (S7-1500,
S7-1500T)

Function manuals
Documentation Guide
(S7-1500, S7-1500T)

1

Introduction (S7-1500,
S7-1500T)

2

Basics (S7-1500, S7-1500T)

3

Using versions (S7-1500,
S7-1500T)

4

Configuring (S7-1500,
S7-1500T)

5

Programming (S7-1500,
S7-1500T)

6

Downloading to CPU
(S7-1500, S7-1500T)

7

Commissioning (S7-1500,
S7-1500T)

8

Diagnostics (S7-1500,
S7-1500T)

9

Appendix (S7-1500,
S7-1500T)



A

TIA Portal V16

Legal information

Warning notice system

This manual contains notices you have to observe in order to ensure your personal safety, as well as to prevent damage to property. The notices referring to your personal safety are highlighted in the manual by a safety alert symbol, notices referring only to property damage have no safety alert symbol. These notices shown below are graded according to the degree of danger.

 DANGER
indicates that death or severe personal injury will result if proper precautions are not taken.
 WARNING
indicates that death or severe personal injury may result if proper precautions are not taken.
 CAUTION
indicates that minor personal injury can result if proper precautions are not taken.
NOTICE
indicates that property damage can result if proper precautions are not taken.

If more than one degree of danger is present, the warning notice representing the highest degree of danger will be used. A notice warning of injury to persons with a safety alert symbol may also include a warning relating to property damage.

Qualified Personnel

The product/system described in this documentation may be operated only by **personnel qualified** for the specific task in accordance with the relevant documentation, in particular its warning notices and safety instructions. Qualified personnel are those who, based on their training and experience, are capable of identifying risks and avoiding potential hazards when working with these products/systems.

Proper use of Siemens products

Note the following:

 WARNING
Siemens products may only be used for the applications described in the catalog and in the relevant technical documentation. If products and components from other manufacturers are used, these must be recommended or approved by Siemens. Proper transport, storage, installation, assembly, commissioning, operation and maintenance are required to ensure that the products operate safely and without any problems. The permissible ambient conditions must be complied with. The information in the relevant documentation must be observed.

Trademarks

All names identified by ® are registered trademarks of Siemens AG. The remaining trademarks in this publication may be trademarks whose use by third parties for their own purposes could violate the rights of the owner.

Disclaimer of Liability

We have reviewed the contents of this publication to ensure consistency with the hardware and software described. Since variance cannot be precluded entirely, we cannot guarantee full consistency. However, the information in this publication is reviewed regularly and any necessary corrections are included in subsequent editions.

Preface (S7-1500, S7-1500T)

Purpose of the documentation

This documentation provides important information that you need to configure and commission the integrated Motion Control functionality of the S7-1500 Automation systems.

Required basic knowledge

In order to understand this documentation, the following knowledge is required:

- General knowledge in the field of automation
- General knowledge in the field of drive engineering and motion control

Validity of the documentation

This documentation is valid for the S7-1500 product range.

Conventions

- For the path settings in the project navigation it is presumed that the "Technology objects" object is opened in the CPU subtree. The "Technology object" placeholder represents the name of the technology object.

Example: "Technology object > Configuration > Basic parameters".

- The <TO> placeholder represents the name set in tags for the respective technology object.

Example: <TO>.Actor.Type

- This documentation contains pictures of the devices described. The pictures may differ in minor details from the devices supplied.

You should also observe the notes that are marked as follows:

Note

A note contains important information about the product described in the documentation, about the handling of the product, and about sections in this documentation demanding your particular attention.

Further support

- The range of technical documentation for the individual SIMATIC products and systems is available on the Internet (<http://www.siemens.com/simatic-tech-doku-portal>).
- The online catalog and the online ordering system is available on the Internet (<http://mall.industry.siemens.com>).

Security information (S7-1500, S7-1500T)

Siemens provides products and solutions with industrial security functions that support the secure operation of plants, systems, machines and networks.

In order to protect plants, systems, machines and networks against cyber threats, it is necessary to implement – and continuously maintain – a holistic, state-of-the-art industrial security concept. Siemens' products and solutions constitute one element of such a concept.

Customers are responsible for preventing unauthorized access to their plants, systems, machines and networks. Such systems, machines and components should only be connected to an enterprise network or the internet if and to the extent such a connection is necessary and only when appropriate security measures (e.g. firewalls and/or network segmentation) are in place.

For additional information on industrial security measures that may be implemented, please visit (<https://www.siemens.com/industrialsecurity>).

Siemens' products and solutions undergo continuous development to make them more secure. Siemens strongly recommends that product updates are applied as soon as they are available and that the latest product versions are used. Use of product versions that are no longer supported, and failure to apply the latest updates may increase customers' exposure to cyber threats.

To stay informed about product updates, subscribe to the Siemens Industrial Security RSS Feed visit (<https://www.siemens.com/industrialsecurity>).

Table of contents

	Preface (S7-1500, S7-1500T)	3
1	Function manuals Documentation Guide (S7-1500, S7-1500T)	8
2	Introduction (S7-1500, S7-1500T)	10
2.1	Interplay of the various documents (S7-1500, S7-1500T).....	10
2.2	Integrated Motion Control functionality (S7-1500, S7-1500T)	11
2.3	Principle of operation of S7-1500 Motion Control (S7-1500, S7-1500T).....	12
2.4	Guidelines on use of motion control (S7-1500, S7-1500T)	17
3	Basics (S7-1500, S7-1500T)	18
3.1	Technology objects (S7-1500, S7-1500T).....	18
3.2	Configuration limits (S7-1500, S7-1500T)	20
3.3	Units of measure (S7-1500, S7-1500T).....	21
3.4	Process response (S7-1500, S7-1500T)	23
3.4.1	Organization blocks for Motion Control (S7-1500, S7-1500T).....	23
3.4.2	Process image partition "OB Servo PIP" (S7-1500, S7-1500T)	26
3.4.3	Operational Sequence and Timeouts (S7-1500, S7-1500T)	26
3.4.4	Operating modes (S7-1500, S7-1500T)	29
4	Using versions (S7-1500, S7-1500T)	32
4.1	Overview of versions (S7-1500, S7-1500T).....	32
4.2	Version V5.0 (S7-1500, S7-1500T)	36
4.3	Version V4.0 (S7-1500, S7-1500T)	41
4.4	Version V3.0 (S7-1500, S7-1500T)	44
4.5	Version V2.0 (S7-1500, S7-1500T)	46
4.6	Version V1.0 (S7-1500, S7-1500T)	47
4.7	Changing a technology version (S7-1500, S7-1500T)	48
4.8	Replacing devices (S7-1500, S7-1500T).....	50
5	Configuring (S7-1500, S7-1500T)	51
5.1	Adding and configuring drives in the device configuration (S7-1500, S7-1500T)	51
5.1.1	Adding and configuring PROFINET IO drives (S7-1500, S7-1500T)	52
5.1.2	Adding and configuring PROFIBUS DP drives (S7-1500, S7-1500T).....	55
5.1.3	Adding and configuring drives with analog connections (S7-1500, S7-1500T).....	57

5.2	Configuration basics (S7-1500, S7-1500T)	60
5.2.1	Add technology object (S7-1500, S7-1500T).....	60
5.2.2	Copy technology object (S7-1500, S7-1500T).....	61
5.2.3	Delete technology object (S7-1500, S7-1500T).....	62
5.2.4	Working with the configuration editor (S7-1500, S7-1500T).....	62
5.2.5	Compare values (S7-1500, S7-1500T).....	63
5.3	Configuring technological modules and onboard I/O for Motion Control (S7-1500, S7-1500T)	65
5.3.1	TM Count 1x24V/TM Count 2x24V (S7-1500, S7-1500T).....	67
5.3.2	TM PosInput 1/TM PosInput 2 (S7-1500, S7-1500T)	69
5.3.3	TM Timer DIDQ 10x24V/TM Timer DIDQ 16x24V (S7-1500, S7-1500T).....	72
5.3.4	TM Pulse 2x24V (S7-1500, S7-1500T).....	73
5.3.5	TM PTO 4 (S7-1500, S7-1500T).....	74
5.3.6	CPU 1511C-1 PN/CPU 1512C-1 PN (onboard I/O devices) (S7-1500, S7-1500T)	77
5.3.7	SIMATIC Drive Controller (onboard I/O) (S7-1500T).....	83
5.4	Connect drive/encoder via data block (S7-1500, S7-1500T).....	84
5.5	Parameter view (S7-1500, S7-1500T)	85
5.5.1	Structure of the parameter view (S7-1500, S7-1500T).....	88
5.5.1.1	Toolbar (S7-1500, S7-1500T).....	88
5.5.1.2	Navigation (S7-1500, S7-1500T)	89
5.5.1.3	Parameter table (S7-1500, S7-1500T)	89
5.5.2	Opening the parameter view (S7-1500, S7-1500T).....	91
5.5.3	Working with the parameter view (S7-1500, S7-1500T).....	91
5.5.3.1	Filtering the parameter table (S7-1500, S7-1500T)	92
5.5.3.2	Sorting the parameter table (S7-1500, S7-1500T)	92
5.5.3.3	Transferring parameter data to other editors (S7-1500, S7-1500T)	93
5.5.3.4	Indicating errors (S7-1500, S7-1500T)	93
5.5.3.5	Editing start values in the project (S7-1500, S7-1500T).....	94
5.5.3.6	Monitoring values online in the parameter view (S7-1500, S7-1500T).....	95
5.5.3.7	Modifying values (S7-1500, S7-1500T)	96
5.5.3.8	Comparing values (S7-1500, S7-1500T).....	97
6	Programming (S7-1500, S7-1500T)	98
6.1	Technology data block (S7-1500, S7-1500T).....	98
6.1.1	Evaluating the technology data block (S7-1500, S7-1500T)	99
6.1.2	Evaluate StatusWord, ErrorWord and WarningWord (S7-1500, S7-1500T)	101
6.1.3	Change restart-relevant data (S7-1500, S7-1500T)	103
6.2	Motion Control instructions (S7-1500, S7-1500T)	104
6.2.1	Motion Control instruction parameters (S7-1500, S7-1500T).....	104
6.2.2	Add Motion Control instructions (S7-1500, S7-1500T).....	108
6.2.3	Parameter transfer for function blocks (S7-1500, S7-1500T).....	110
6.3	Starting Motion Control jobs (S7-1500, S7-1500T).....	112
6.4	Tracking active jobs (S7-1500, S7-1500T)	114
6.4.1	Motion Control instructions with "Done" parameter (S7-1500, S7-1500T)	114
6.4.2	Motion Control instructions without "Done" parameter (S7-1500, S7-1500T)	119
6.4.3	Motion Control instruction "MC_MoveJog" (S7-1500, S7-1500T)	123
6.5	Ending Motion Control jobs (S7-1500, S7-1500T).....	126
6.6	Restart of technology objects (S7-1500, S7-1500T).....	127

7	Downloading to CPU (S7-1500, S7-1500T)	128
8	Commissioning (S7-1500, S7-1500T)	129
8.1	Commissioning guidelines (S7-1500, S7-1500T)	130
9	Diagnostics (S7-1500, S7-1500T)	133
9.1	Diagnostic concept (S7-1500, S7-1500T).....	134
9.2	Technology alarms (S7-1500, S7-1500T).....	135
9.3	Errors in Motion Control instructions (S7-1500, S7-1500T).....	139
A	Appendix (S7-1500, S7-1500T)	140
A.1	Technology alarms (S7-1500, S7-1500T).....	140
A.1.1	Overview of the technology alarms (S7-1500, S7-1500T).....	140
A.1.2	Technology alarms 101-114 (S7-1500, S7-1500T)	144
A.1.3	Technology alarms 201-204 (S7-1500, S7-1500T)	151
A.1.4	Technology alarms 304-343 (S7-1500, S7-1500T)	152
A.1.5	Technology alarms 401-431 (S7-1500, S7-1500T)	155
A.1.6	Technology alarms 501-552 (S7-1500, S7-1500T)	158
A.1.7	Technology alarms 601-613 (S7-1500, S7-1500T)	164
A.1.8	Technology alarms 700-758 (S7-1500, S7-1500T)	166
A.1.9	Technology alarms 900-902 (S7-1500, S7-1500T)	170
A.2	Error ID for Motion Control instructions (S7-1500, S7-1500T)	171
A.3	SINAMICS drives (S7-1500, S7-1500T)	176
A.3.1	Compatibility list (S7-1500, S7-1500T)	177
A.3.2	Homing SINAMICS drives with external zero marks (S7-1500, S7-1500T)	177
A.4	Data types (S7-1500, S7-1500T).....	178
	Glossary (S7-1500, S7-1500T)	179
	Index	183

Function manuals Documentation Guide (S7-1500, S7-1500T)

1

The documentation for the SIMATIC S7-1500 automation system, for CPU 1516pro-2 PN based on SIMATIC S7-1500, and for the distributed I/O systems SIMATIC ET 200MP, ET 200SP and ET 200AL is divided into three areas.

This division allows you easier access to the specific information you require.

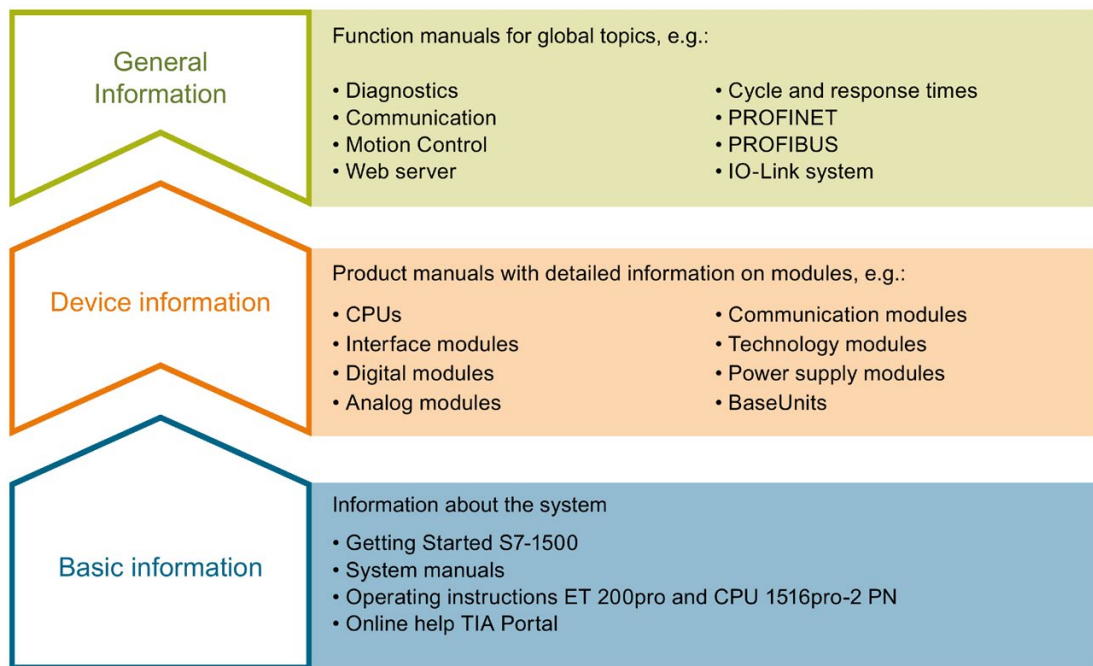

Basic information

System manuals and Getting Started manuals describe in detail the configuration, installation, wiring and commissioning of the SIMATIC S7-1500, ET 200MP, ET 200SP and ET 200AL systems; use the corresponding operating instructions for CPU 1516pro-2 PN. The STEP 7 online help supports you in configuration and programming.

Device information

Product manuals contain a compact description of the module-specific information, such as properties, terminal diagrams, characteristics and technical specifications.

General information

The function manuals contain detailed descriptions on general topics such as diagnostics, communication, Motion Control, Web server, OPC UA.

You can download the documentation free of charge from the Internet (<https://support.industry.siemens.com/cs/ww/en/view/109742705>).

Changes and additions to the manuals are documented in product information sheets.

You will find the product information on the Internet:

- S7-1500/ET 200MP (<https://support.industry.siemens.com/cs/us/en/view/68052815>)
- ET 200SP (<https://support.industry.siemens.com/cs/us/en/view/73021864>)
- ET 200AL (<https://support.industry.siemens.com/cs/us/en/view/99494757>)

Manual Collections

The Manual Collections contain the complete documentation of the systems put together in one file.

You will find the Manual Collections on the Internet:

- S7-1500/ET 200MP (<https://support.industry.siemens.com/cs/ww/en/view/86140384>)
- ET 200SP (<https://support.industry.siemens.com/cs/ww/en/view/84133942>)
- ET 200AL (<https://support.industry.siemens.com/cs/ww/en/view/95242965>)

"mySupport"

With "mySupport", your personal workspace, you make the best out of your Industry Online Support.

In "mySupport", you can save filters, favorites and tags, request CAx data and compile your personal library in the Documentation area. In addition, your data is already filled out in support requests and you can get an overview of your current requests at any time.

You must register once to use the full functionality of "mySupport".

You can find "mySupport" on the Internet (<https://support.industry.siemens.com/My/ww/en>).

Application examples

The application examples support you with various tools and examples for solving your automation tasks. Solutions are shown in interplay with multiple components in the system - separated from the focus on individual products.

You will find the application examples on the Internet (<https://support.industry.siemens.com/sc/ww/en/sc/2054>).

Introduction (S7-1500, S7-1500T)

2.1 Interplay of the various documents (S7-1500, S7-1500T)

For a better overview, the documentation of the Motion Control functions is divided into the following documents:

Documentation	Description
S7-1500/S7-1500T Motion Control overview Function manual "S7-1500/S7-1500T Motion Control overview" https://support.industry.siemens.com/cs/ww/en/view/109766459	This documentation describes the Motion Control functions independent of and across technology objects.
Using S7-1500/S7-1500T axis functions Function manual "S7-1500/S7-1500T Axis functions" https://support.industry.siemens.com/cs/ww/en/view/109766462	This documentation describes the Motion Control functions for the following technology objects: <ul style="list-style-type: none"> • Speed axis • Positioning axis • External encoder
Using S7-1500/S7-1500T measuring input and output cam functions Function manual "S7-1500/S7-1500T Measuring input and output cam functions" https://support.industry.siemens.com/cs/ww/en/view/109766466	This documentation describes the Motion Control functions for the following technology objects: <ul style="list-style-type: none"> • Measuring input • Output cam • Cam track
Using S7-1500/S7-1500T synchronous operation functions Function manual "S7-1500/S7-1500T Synchronous operation functions" https://support.industry.siemens.com/cs/ww/en/view/109766464	This documentation describes the Motion Control functions for the following technology objects: <ul style="list-style-type: none"> • Synchronous axis • Cam (S7-1500T) • Leading axis proxy (S7-1500T)
Using S7-1500T kinematics functions Function manual "S7-1500T Kinematics functions" https://support.industry.siemens.com/cs/ww/en/view/109766463	This documentation describes the Motion Control functions for the following technology objects: <ul style="list-style-type: none"> • Kinematics (S7-1500T)

Additional information

You can find an overview and important links to the topic "SIMATIC Motion Control" in the Siemens Industry Online Support under the entry ID 109751049 (<https://support.industry.siemens.com/cs/ww/en/view/109751049>).

2.2 Integrated Motion Control functionality (S7-1500, S7-1500T)

S7-1500 Motion Control supports closed-loop positioning and moving of axes and is an integrated part of the CPUs:

- Advanced Controller S7-1500(F)/S7-1500T(F)
- Distributed Controller S7-1500SP (F)/S7-1500SP T(F)
- Software Controller S7-1507S (F)
- Drive Controller S7-150xD TF

The S7-1500T Technology CPUs provide enhanced functions.

The Motion Control functionality supports the following technology objects:

- Speed axis
- Positioning axis
- Synchronous axis
- External encoder
- Measuring input
- Output cam
- Cam track
- Cam (S7-1500T)
- Kinematics (S7-1500T)
- Leading axis proxy (S7-1500T)

Drives with PROFIdrive capability and drives with analog setpoint interface and stepper motors are controlled by means of standardized Motion Control instructions according to PLCopen.

The axis control panel and comprehensive online and diagnostic functions support easy commissioning and optimization of drives.

S7-1500 Motion Control is fully integrated into the system diagnostics of the S7-1500 CPU.

2.3 Principle of operation of S7-1500 Motion Control (S7-1500, S7-1500T)

You create a project, configure technology objects, and download the configuration to the CPU with the TIA Portal. The Motion Control functionality is processed in the CPU. You control the technology objects by using the Motion Control instructions in your user program. The TIA Portal provides additional functions for commissioning (Page 129), optimization and diagnostics (Page 133).

The following figure provides a schematic representation of the user interfaces and the integration of Motion Control into the S7-1500 CPU. The concepts are then briefly explained:

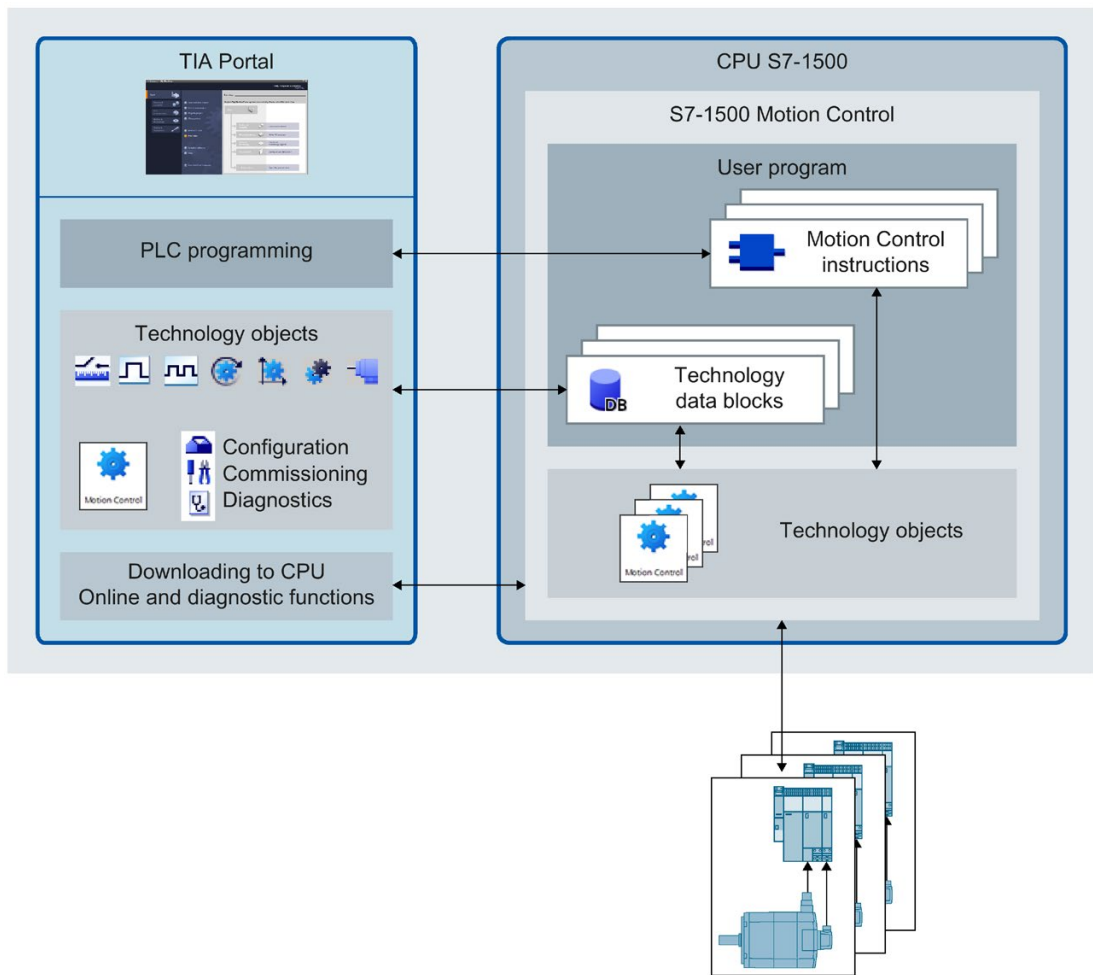

TIA Portal

The TIA Portal supports you in the planning and commissioning of Motion Control functionality:

- Integrating and configuring hardware
- Creating and configuring technology objects
- Creating the user program
- Downloading to CPU
- Commissioning of axes
- Optimization of drives
- Diagnostics

You use the TIA Portal to configure the hardware, the technology objects as well as your user program. You download the program you created to the CPU. You test your user program and diagnose the hardware with the online and diagnostic functions of the TIA Portal.





Technology objects









Technology objects represent real objects (e.g. an axis) in the controller. You call the functions of the technology objects by means of Motion Control instructions in your user program. These functions are executed in the Motion Control organization blocks (Page 23) independently of the user program. The technology objects provide open- and closed-loop control of the movement of the real objects, and report status information (e.g. the current position).

The configuration of the technology objects represents the properties of the real object. The configuration data is stored in a technology data block.

The following technology objects are available for Motion Control:

Symbol	Technology object	Description
	Speed axis	The speed axis technology object ("TO_SpeedAxis") is used to specify the speed for a drive. You program the motion of the axis with motion control instructions.
	Positioning axis	The positioning axis technology object ("TO_PositioningAxis") is used to position a drive with closed-loop position control. You issue positioning jobs to the axis with Motion Control instructions in your user program.
	Synchronous axis	The synchronous axis technology object ("TO_SynchronousAxis") includes all functions of the positioning axis technology object. The axis can also be interconnected with a leading value so that the axis follows the position change of a leading axis in synchronous operation.
	Leading axis proxy (S7-1500T)	With cross-PLC synchronous operation, the leading axis proxy technology object ("TO_LeadingAxisProxy") represents the leading axis for local synchronous operation within a CPU. The leading axis proxy evaluates the leading value telegram and provides the external leading value for the local synchronous axes.

Symbol	Technology object	Description
	External encoder	The external encoder technology object ("TO_ExternalEncoder") detects a position and makes it available to the controller. The detected position can be evaluated in the user program.
	Measuring input	The measuring input technology object ("TO_MeasuringInput") detects actual positions quickly, accurately and event triggered.
	Output cam	The output cam technology object ("TO_OutputCam") generates switching signals depending on the position of an axis or external encoder. You can evaluate the switching signals in the user program or feed them to digital outputs.
	Cam track	The cam track technology object ("TO_CamTrack") generates a switching signal sequence depending on the position of an axis or external encoder. In this process, up to 32 individual cams are superimposed and the switching signals are output as a track. You can evaluate the switching signals in the user program or feed them to digital outputs.
	Cam (S7-1500T)	The cam technology object ("TO_Cam") specifies a synchronization function $F(x)$ for camming, over which the leading and following axes are coupled. The $f(x)$ function is defined by interpolation points and/or segments. Missing function ranges are interpolated.
	Kinematics (S7-1500T)	The Kinematic technology object ("TO_Kinematics") is used to interconnect positioning axes to a kinematic. When you configure the kinematics technology object, you interconnect the axes in accordance with the configured kinematics type.

Technology data block



The properties of real objects are configured by means of the technology objects and saved in a technology data block (Page 98). The technology data block contains all configuration data, setpoint and actual values, and status information of the technology object. The TIA Portal automatically creates the technology data block when the technology object is created. You access the data of the technology data block (read/write access) with your user program.

Motion Control instructions



With the Motion Control instructions you perform the desired functionality in the technology objects. The Motion Control instructions are available in the TIA Portal under "Instructions > Technology > Motion Control". The instructions can be called at all execution levels.



The Motion Control instructions conform to PLCopen (version 2.0).

User program

The Motion Control instructions and the technology data block represent the programming interfaces for the technology objects. You use Motion Control instructions to transfer Motion Control jobs for the technology objects in your user program. The technology objects process the jobs in the Motion Control organization blocks, which are called independently of the user program, and flag the current status to the Motion Control instruction. Each time the Motion Control instruction is called, the current status of the current job is displayed at the output parameters of the Motion Control instruction. You access status information of the technology object and change specific configuration parameters during runtime using the technology data block.

Drives and encoders

Drives ensure the motion of the axis. They are integrated in the hardware configuration.

When you execute a Motion Control job in your user program, the technology object takes over the control of the drive and the reading in of values of encoders.

Drives and encoders with PROFIdrive capability are connected by means of PROFIdrive telegrams. The following connections are possible:

- PROFINET IO
- PROFIBUS DP
- Technology module (TM)
- SINAMICS Integrated (SIMATIC Drive Controller)

Drives with analog setpoint interfaces are connected using an analog output (AQ) and an optional enable signal. Analog inputs and outputs are made available by means of corresponding I/O modules.

A drive is also called an actuator, and an encoder is also called a sensor.

The following figure shows an example configuration in which all components are connected to the CPU by means of PROFINET IO:

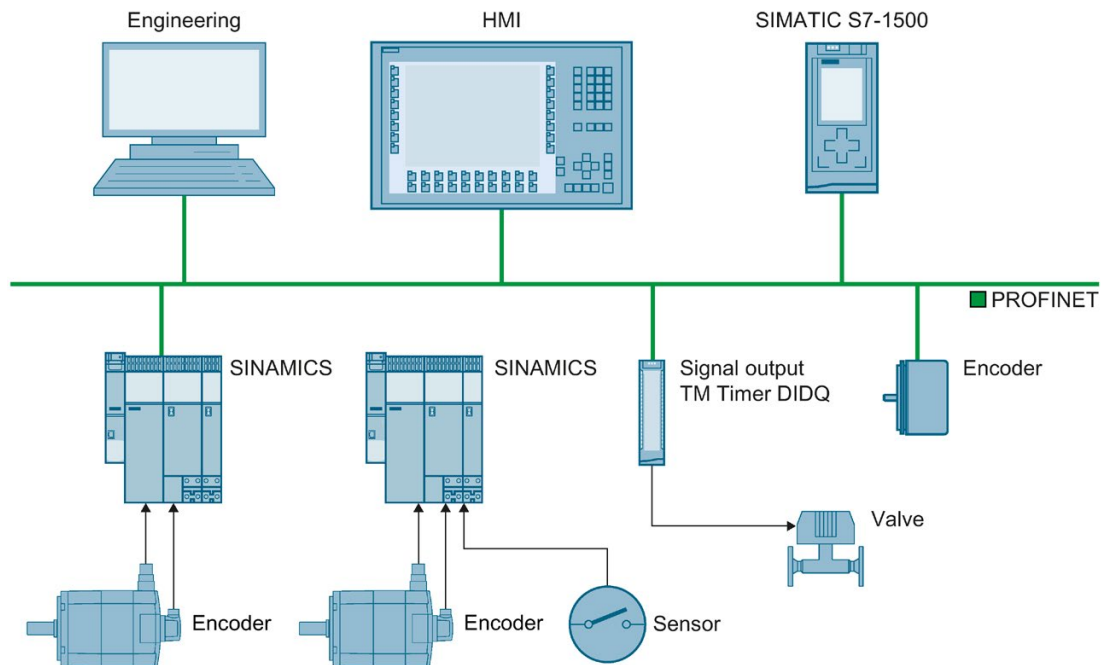

2.4 Guidelines on use of motion control (S7-1500, S7-1500T)

The guidelines described here present the basic procedure for using Motion Control with the CPU S7-1500. These guidelines serve as recommendations.

Requirements

- A project with a CPU S7-1500 has been created.

Procedure







Proceed as follows to use Motion Control with the CPU S7-1500:





1. Add technology object (Page 60)
2. Working with the configuration editor (Page 62)
3. Programming (Page 98)
4. Downloading to CPU (Page 128)
5. Functional test in the Commissioning window (Page 129)
6. Diagnostics (Page 133)

Basics (S7-1500, S7-1500T)

3.1 Technology objects (S7-1500, S7-1500T)

The S7-1500 and S7-1500T CPUs support the following technology objects:

Technology object		Brief description	S7-1500	S7-1500T
	Speed axis	The speed axis technology object calculates speed setpoints, taking into account the dynamic settings, and outputs them to the drive. All motions of the speed axis take place as speed-controlled motions. The speed axis technology object is described in the documentation "S7-1500/S7-1500T Axis functions" (https://support.industry.siemens.com/cs/ww/en/view/109766462).	x	x
	Positioning axis	The positioning axis technology object calculates position setpoints, taking into account the dynamic specification position setpoints, and outputs corresponding speed setpoints to the drive. The positioning axis technology object is described in the documentation "S7-1500/S7-1500T Axis functions" (https://support.industry.siemens.com/cs/ww/en/view/109766462).	x	x
	Synchronous axis	The synchronous axis technology object includes all functions of the positioning axis technology object. A synchronous axis can also follow the motions of a leading axis. The synchronous axis technology object is described in the documentation "S7-1500/S7-1500T Synchronous operation functions" (https://support.industry.siemens.com/cs/ww/en/view/109766464).	x	x
	External encoder	The external encoder technology object detects a position and makes this available to the controller. The external encoder technology object is described in the documentation "S7-1500/S7-1500T Axis functions" (https://support.industry.siemens.com/cs/ww/en/view/109766462).	x	x
	Measuring input	The measuring input technology object acquires the actual position of an axis or external encoder at a signal change at the measuring input. The measuring input technology object is described in the documentation "S7-1500/S7-1500T Measuring input and output cam functions" (https://support.industry.siemens.com/cs/ww/en/view/109766466).	x	x
	Output cam	The output cam technology object generates switching signals depending on the position of an axis or external encoder. The output cam technology object is described in the documentation "S7-1500/S7-1500T Measuring input and output cam functions" (https://support.industry.siemens.com/cs/ww/en/view/109766466).	x	x

Technology object	Brief description	S7-1500	S7-1500T
 Cam track	<p>The cam track technology object generates a switching signal sequence depending on the position of an axis or external encoder. A cam track can consist of up to 32 individual output cams and be output to one output.</p> <p>The cam track technology object is described in the documentation "S7-1500/S7-1500T Measuring input and output cam functions" (https://support.industry.siemens.com/cs/ww/en/view/109766466).</p>	x	x
 Cam	<p>The cam technology object defines a transfer function $y = f(x)$. The dependency of an output variable on an input variable is described in this transfer function in a unit-neutral manner.</p> <p>The cam technology object is described in the documentation "S7-1500/S7-1500T Synchronous operation functions" (https://support.industry.siemens.com/cs/ww/en/view/109766464).</p>	-	x
 Leading axis proxy	<p>With cross-PLC synchronous operation, the leading axis proxy technology object represents the leading axis for local synchronous operation within a CPU.</p> <p>The synchronous axis technology object is described in the documentation "S7-1500/S7-1500T Synchronous operation functions" (https://support.industry.siemens.com/cs/ww/en/view/109766464).</p>	-	x
 Kinematics	<p>The kinematics technology object calculates motion setpoints for the tool center point (TCP) of the kinematics taking into account the dynamic settings.</p> <p>The Kinematics technology object is described in the documentation "S7-1500T Kinematics functions" (https://support.industry.siemens.com/cs/ww/en/view/109766463).</p>	-	x

3.2 Configuration limits (S7-1500, S7-1500T)

Motion Control resources

Each CPU offers a defined set of Motion Control resources. For information on the available Motion Control resources, refer to the technical specifications of the utilized CPU.

Each technology object uses Motion Control resources:

Technology object	Motion Control resources used
Speed axis	40
Positioning axis	80
Synchronous axis	160
External encoder	80
Measuring input	40
Output cam	20
Cam track	160

You can find an overview of the Motion Control resources of a CPU in the TIA Portal under "Tools > Resources".

Extended Motion Control resources (S7-1500T)

The leading axis proxy, cam and kinematics technology objects use "Extended Motion Control resources". For information on the maximum number of leading axis proxies, cams and kinematics that can be used in addition to the Motion Control resources, refer to the technical specifications of the relevant CPU.

Technology object	Extended Motion Control resources used
Leading axis proxy	3
Cam	2
Kinematics	30

Application cycle

As the number of technology objects used increases, the computing time needed by CPU to process the technology objects increases. The Motion Control application cycle (Page 23) can be adapted according to the number of technology objects used.

3.3 Units of measure (S7-1500, S7-1500T)

The supported units of measure for speed (revolutions per time unit) are 1/s, 1/min and 1/h.

The table below shows the supported units of measure for position and velocity:

Position	Velocity
nm, μ m, mm ¹⁾ , m, km	mm/s ¹⁾ , mm/min, mm/h, m/s, m/min, m/h, km/min, km/h
in, ft, mi	in/s, in/min, ft/s, ft/min, mi/h
^o 1), rad	^o /s ¹⁾ , ^o /min, rad/s, rad/min

¹⁾ Position values with higher resolution or six decimal places

The acceleration is set accordingly as the position/s² unit of measure.

The jerk is set accordingly as the position/s² unit of measure.

The table below shows the supported units of measure for force and torque:

Force	Torque
N, kN	Nm, kNm
lbf, ozf, pdl	lbf in, lbf ft, ozf in, ozf ft, pdl in, pdl ft

The unit of measure for time is permanently specified for the following technology objects:

Technology object	Time
Speed axis, positioning/synchronous axis, external encoder	s
Output cam, cam track, measuring input	ms

Note

When setting or changing the units of measure, take into consideration the effect on the display of parameter values and the user program:

- Display of parameter values in the technology data block
- Assignment of parameters in the user program
- Input and display of the position and velocity in the TIA Portal
- Setpoint settings by leading axes in synchronous operation

All information and displays correspond to the selected unit of measure.

The set units are displayed in the tag structure of the <TO>.Units technology object. The tag structure is described in the Appendix (Page 140) under the tags of the respective technology object.

Position values with higher resolution

If you select the check box "Use position values with higher resolution" in the configuration of the technology objects "TO_PositioningAxis", "TO_SynchronousAxis", "TO_ExternalEncoder" and "TO_Kinematics", six decimal places are available in the selected unit. The displayable position and angle range in [mm] and [°] is limited in LREAL format to +9.0E09 digits. This reduces the position and angle range that can be displayed as well as the mechanical gear ratio by the factor 1000. With regard to long-term stability, the numerical travel range limit is reduced accordingly by the factor 1000.

3.4 Process response (S7-1500, S7-1500T)

3.4.1 Organization blocks for Motion Control (S7-1500, S7-1500T)

When you create a technology object, organization blocks MC-Servo [OB91] and MC-Interpolator [OB92] are automatically created for processing the technology objects. The organization block MC-LookAhead [OB97] is also created for the kinematics technology object as of technology version 5.0. The technology objects are processed in the Motion Control application cycle. The application cycle consists of required and optional organization blocks (OBs).

In the user program, call the appropriate Motion Control instruction and start a Motion Control job for a technology object. In the organization block Main [OB1], call the user program cyclically.

Optionally, programmable Motion Control OBs are available, which you must insert manually. These organization blocks take into account special requirements with regard to time-critical events or the time sequence of function calls. This makes it possible, for example, to start motions immediately in the event of time-critical events.

The following table shows the organization blocks for Motion Control:

Organization block	Description	Priority ¹⁾
MC-PreServo [OB67] (optional)	For For example: Preparation of the telegram contents from the drive system. Is called immediately before the MC-Servo [OB91].	Corresponds to MC-Servo
MC-Servo [OB91] (know-how-protected)	Calculation of the position controller System performance, no user program possible.	17 to 26 Default 26
MC-PostServo [OB95] (optional)	For For example: Preparation of the setpoints for the drive system. Is called immediately after the MC-Servo [OB91].	Corresponds to MC-Servo
MC-Transformation [OB98] (optional)	Programming of the transformation of Cartesian coordinates and axis-specific setpoints for user-defined kinematics	17 to 25 Default 25
MC-PreInterpolator [OB68] (optional)	For For example: MotionIn instructions for measuring inputs, output cams and cam tracks The MC-PreInterpolator [OB68] is required for iposynchronous processing of Motion Control instructions. Is called immediately before the MC-Interpolator [OB92].	Corresponds to MC-Interpolator
MC-Interpolator [OB92] (know-how-protected)	Evaluation of the Motion Control instructions, generation of setpoints and monitoring functionality System performance, no user program possible.	16 to 25 Default 24
MC-LookAhead [OB97] (know-how-protected)	Calculation of the motion processing of the kinematics technology object Applies only to a technology object kinematics V5.0 or higher. System performance, no user program possible.	15 to 16 Default 15

¹⁾ 26 corresponds to highest priority.

The clock ratio of the two organization blocks MC-Servo [OB91] and MC-Interpolator [OB92] to each other is always 1:1. You can scale the ratio of the bus clock to the application cycle.

You can set the application cycle and the priority of the organization blocks according to your requirements for control quality and system load.

You can check the runtime of the respective organization block (except MC-LookAhead [OB97]) with the instruction "RT_INFO". The current application cycle (in μ s) of the organization blocks MC-PreServo [OB67] and MC-PostServo [OB95] and MC-PreInterpolator [OB68] can be read using the start information.

Application cycle

In the properties of the organization block MC-Servo [OB91], you can set the application cycle in which the organization blocks for MC-Servo [OB91], MC-Interpolator [OB92] and their optional OBs are called:

- **Synchronous to the bus (recommended setting for optimum control quality)**

The application cycle is synchronous to the selected source of the send clock and the corresponding reduction ratio. The following clock sources are available for selection:

- PROFINET IO
- PROFIBUS DP
- Local bus system (as of firmware version \geq 2.6)
- PROFIdrive system for SINAMICS Integrated of SIMATIC Drive Controller

A bus system that is connected to the CPU via a communication processor/communication module (CP/CM) cannot be used synchronously.

- **Cyclic**

The application cycle is called at the specified time interval. Processing is asynchronous to the bus clock/send clock.

Possibilities of influencing the process behavior

The system load is primarily determined by the quantity structure (number of technology objects), the communication load and the user program. The processing time in the application cycle increases with the number of technology objects (MC-Servo [OB91]). Simultaneous starting of Motion Control instructions results in additional processing times in the application cycle (MC-Interpolator [OB92] and MC-LookAhead [OB97]) at short notice. Optional Motion Control OBs additionally affect the processing time of the application cycle.

You define the available processing time using the set application cycle. The time available at the end of the application cycle is used for processing the low-priority OBs with the other user program.

The cycle time of the Main [OB1] can increase significantly due to longer processing times in the application cycle.

System overloads are indicated by timeouts or overflows (Page 26) of Main [OB1], MC-Servo [OB91] and MC-Interpolator [OB92].

You have the following options for influencing the system load and the processing times of the user program:

- Reduce the bus clock
- Reduce clock
- Reduce the percentage cycle load of the MC-LookAhead [OB97] (adjustment range 1% to 40%, default setting 20%)
- Reduce percentage communication load of the CPU
- To relieve the load on MC-Interpolator [OB92] and MC-LookAhead [OB97], avoid simultaneous starting of Motion Control instructions

If necessary, use one or more options to optimize the system and the flow behavior.

Clock reduction ratio (as of firmware version 1.5)

You can reduce the application cycle of the MC-Servo [OB91] to the send clock of the selected isochronous bus system. You can set an integer multiple of the send clock as the factor. A maximum cycle time of 32 ms is possible for the application cycle.

If you call an isochronous mode interrupt OB and the MC-Servo [OB91] with the same bus system, you must set the same factor for both organization blocks.

Priority

You can configure the priority of the organization blocks as needed in their properties under "General > Properties > Priority".

When setting the priorities, make sure that the MC-Servo [OB91] is always set before the MC-PreInterpolator [OB68] and the MC-Interpolator [OB92]. The priority of MC-Servo [OB91] must be at least one higher than the priority of MC-Interpolator [OB92]. The priority of the MC-LookAhead [OB97] must be at least one level higher than the priority of cyclic interrupts.

3.4.2 Process image partition "OB Servo PIP" (S7-1500, S7-1500T)

The process image partition "OB Servo PIP" is made available in isochronous mode for Motion Control when MC-Servo [OB91] is called. All drives and encoders used by Motion Control are assigned to this process image partition.

Because the organization blocks MC-PreServo [OB67] and MC-PostServo [OB95] are called automatically by the MC-Servo [OB91], the process image partition is also available automatically. If you use a MC-PreServo [OB67], the data are read in when the MC-PreServo [OB67] starts. If you use a MC-PostServo [OB95], the data are output after the MC-PostServo [OB95].

Additionally, you should assign all I/O modules used by Motion Control to this process image partition (e.g. hardware limit switches). The assignment results in chronologically synchronous processing with the technology object.

The input process image partition is also updated in STOP mode.

Process image partition in the user program

As of firmware version V1.5, you can access the process image partition "OB Servo PIP" in your user program. This makes it possible to evaluate the process image partition using the trace function.

3.4.3 Operational Sequence and Timeouts (S7-1500, S7-1500T)

When processing the Motion Control functionality, the Motion Control organization blocks MC-Servo [OB91] and MC-Interpolator [OB92] including the optional organization blocks are called and processed in each application cycle. Your user program is processed during the remaining time until the next application cycle.

For error-free program execution, keep to the following rules:

- In each application cycle, MC-Servo [OB91] must be started and executed completely.
- In each application cycle, the relevant MC-Interpolator [OB92] must at least be started.

The following figure illustrates the time sequence of the cyclic user program and application cycle:

- The upper section shows the processing of the Main [OB1] without interruption of the application cycle by Motion Control OBs with higher priority.
- The central section shows the processing of Main [OB1] with interruption. Motion Control OBs with higher priority are executed in the application cycle.

The Main [OB1] is interrupted in the cycle of the application cycle; the cycle time of the user program becomes accordingly longer.

- The lower section shows a detailed view of the error-free run behavior of the individual organization blocks.

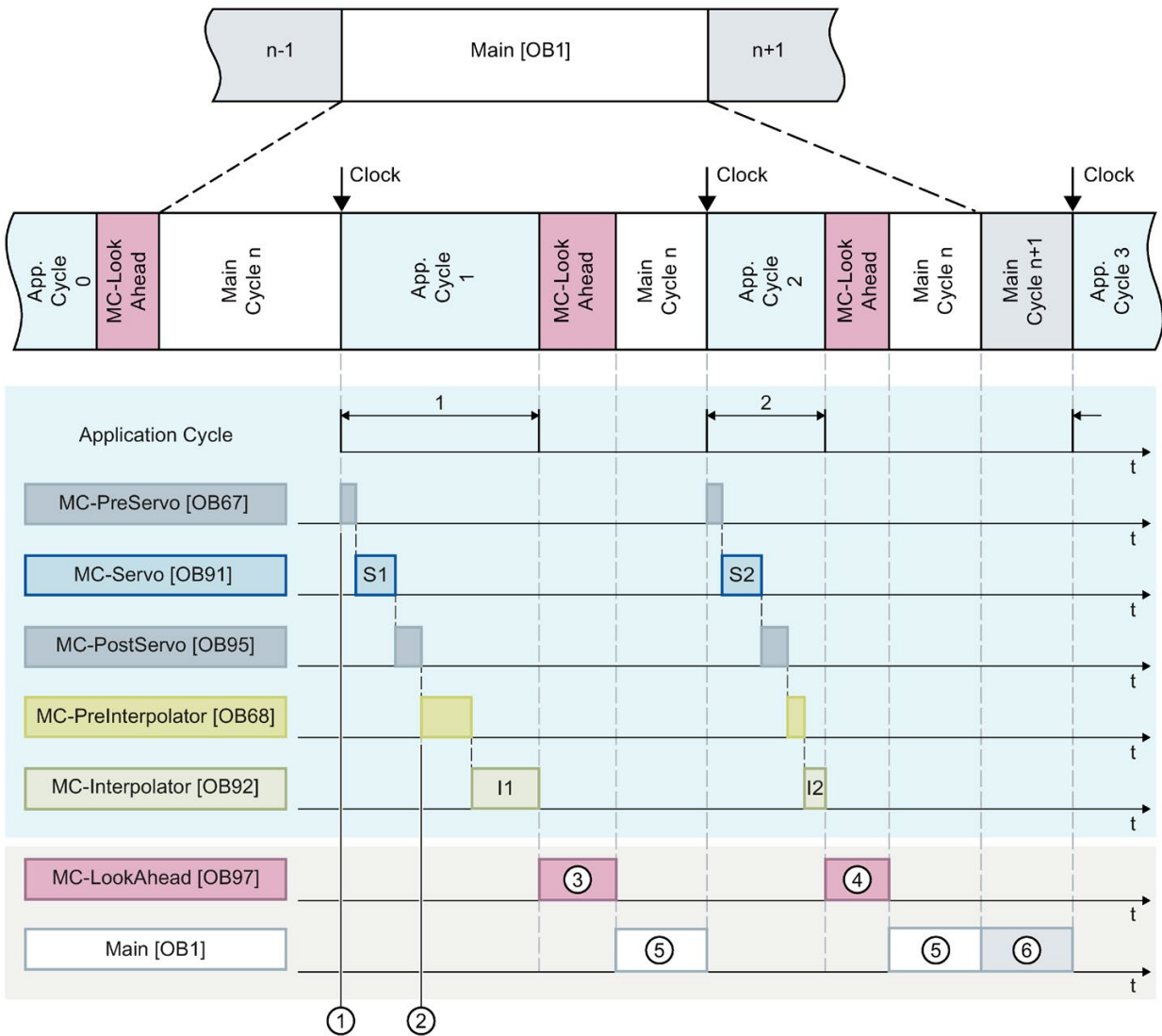

- ① "TPA OB Servo" input process image partition
- ② "TPA OB Servo" output process image partition
- ③ First MC-LookAhead cycle
- ④ Second MC-LookAhead cycle
- ⑤ Main [OB1] cycle n
- ⑥ Main [OB1] cycle n+1

The Motion Control OBs and the Main [OB1] are processed one after the other in application cycle 1. The process image partition "TPA OB SERVO" ① is read before processing the MC-PreServo [OB67]. The MC-Servo [OB91] is displayed as S1 in the first application cycle. After processing the MC-PostServo [OB95], the process image partition "TPA OB SERVO" ② is updated.

The MC-PreInterpolator [OB68] and the MC-Interpolator [OB92] are then processed. The MC-Interpolator [OB92] is displayed as I1 in the first application cycle. Its processing time varies according to the evaluation of the Motion Control instructions as well as the monitoring and setpoint generation for all technology objects configured on the CPU for motion control.

Number ③ represents the processing of the MC-LookAhead [OB97] The Main [OB1] (⑤) is further processed only after all Motion Control OBs have been processed.

In the second application cycle, the processing time for the MC-Interpolator [OB92] I2 and the second MC-LookAhead cycle ④ is shorter than in the first application cycle. The Main [OB1] cycle n ⑤ is finished before the third application cycle. The Main [OB1] cycle n+1 ⑥ is already being processed in the remaining time until the third application cycle. This means that parts of two Main [OB1] cycles can be processed between two application cycles.

Overflows

Overflows can occur if the configured application cycle is not adhered to, for example because additional technology objects or programs are added in the MC-PreServo [OB67] or MC-PostServo [OB95]. The application cycle must be adapted in this case. The MC-Servo [OB91] must be completed before the next send clock, irrespective of the permissible duration of the application cycle.

If the processing time of MC-Servo [OB91] exceeds the duration of a send clock, the message "overflow" is displayed in the diagnostics buffer of the CPU. The controller no longer runs isochronously.

If the processing time exceeds the duration of an application cycle, the CPU switches to STOP operating state.

The following figure shows the behavior in the case of overflow of MC-Servo [OB91] in the application cycle and in the send clock with a reduction ratio of 2:

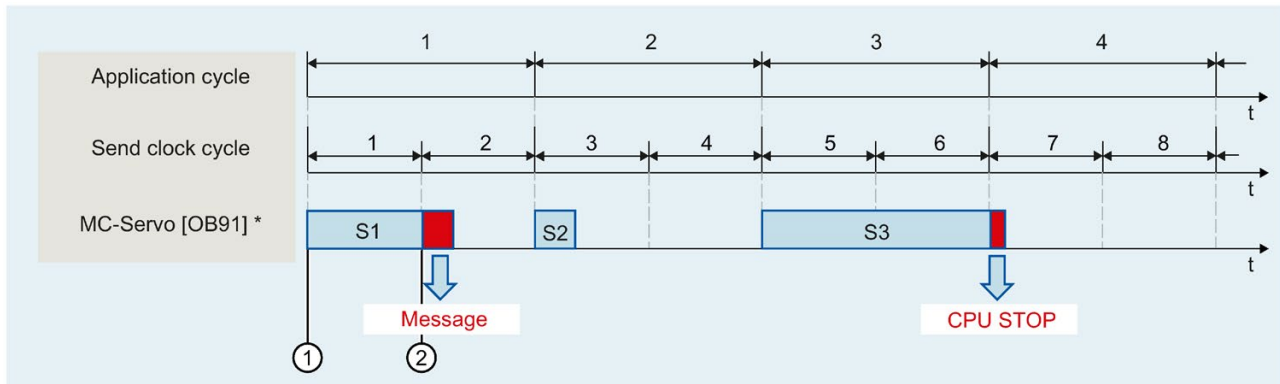

① Start of the processing of MC-Servo [OB91]

② Overflow (message)

* Including MC-PreServo [OB67] and/or MC-PostServo [OB95], when in use

The execution of an MC-Interpolator [OB92] may only be interrupted by an MC-Servo [OB91] call. If more interruptions occur, the CPU switches to STOP mode.

The following figure shows the operational sequence when an MC-Interpolator [OB92] is interrupted over two time slices:

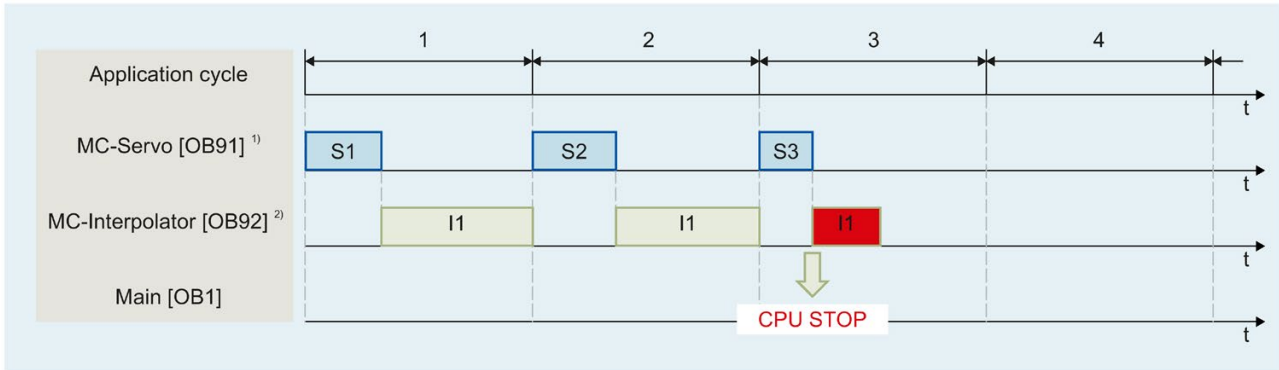

- 1) Including MC-PreServo [OB67] and/or MC-PostServo [OB95], when in use
- 2) Including MC-PreInterpolator [OB68], if available

The CPU tolerates a maximum of three consecutive overflows of MC-Interpolator [OB92]. If more overflows occur, the CPU switches to STOP mode.

The following figure shows the operational sequence if there are four consecutive individual overflows of MC-Interpolator [OB92]:

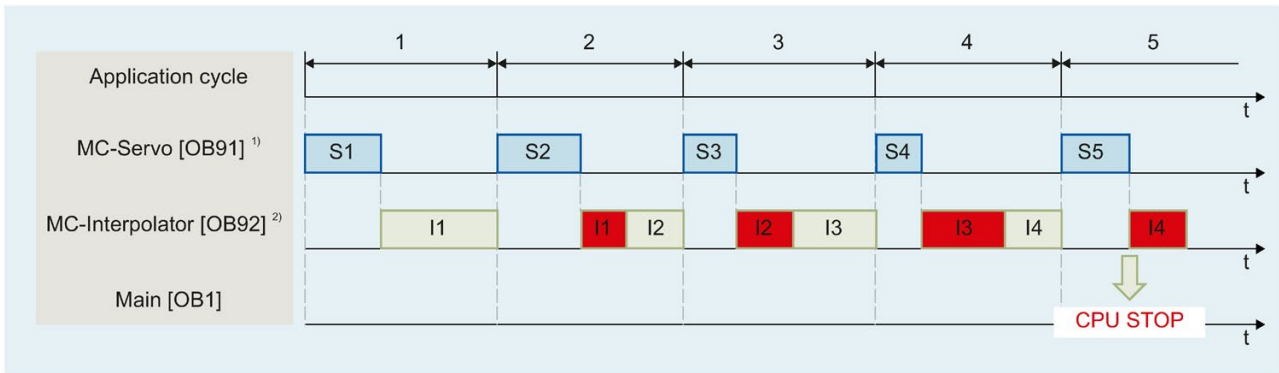

- 1) Including MC-PreServo [OB67] and/or MC-PostServo [OB95], when in use
- 2) Including MC-PreInterpolator [OB68], if available

3.4.4 Operating modes (S7-1500, S7-1500T)

This section examines the behavior of the Motion Control in the respective operating modes and in the transitions between operating modes. A general description of the operating modes can be found in the S7-1500 System Manual

Operating modes and transitions

The CPU has the following operating modes:

- STOP
- STARTUP
- RUN
- HOLD

The following figure shows the operating modes and the operating mode transitions:

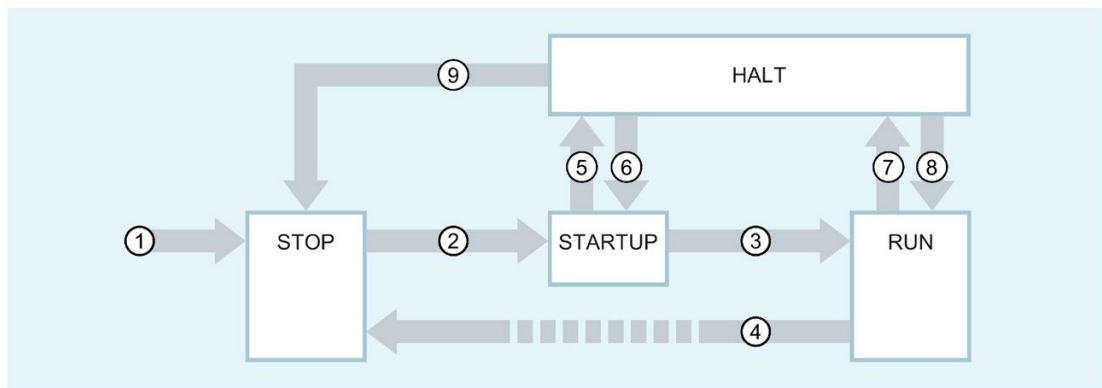

Operating mode transitions

The following table shows the behavior of the Motion Control in the transitions between the operating modes:

No.	Operating mode transition	Behavior
①	POWER ON → STOP	The CPU performs a restart of the technology objects. The technology objects are reinitialized with the values from the load memory.
②	STOP → STARTUP	Not relevant for Motion Control.
③	STARTUP → RUN	The process outputs are enabled.
④	RUN → STOP	When the CPU changes from RUN mode to STOP mode, all technology objects are disabled in accordance with the alarm response "remove enable". Active Motion Control jobs are aborted. If restart-relevant data has been changed for technology objects in RUN, the CPU performs a restart of the corresponding technology objects.
⑤	STARTUP → HOLD	Breakpoint in the start-up routine reached.
⑥	HOLD → STARTUP	Not possible when using technology objects
⑦	RUN → HOLD	Breakpoint reached
⑧	HOLD → RUN	Not possible when using technology objects
⑨	HOLD → STOP	By operation of switch/display or by setting to STOP from programming device.

STOP mode

In STOP mode the user program is not processed and all process outputs are disabled. Thus no Motion Control jobs are executed.

The technology data blocks are updated.

STARTUP mode

Before the CPU starts processing of the cyclical user program, the startup OBs are processed one time.

In STARTUP mode, the process outputs are disabled. Motion Control jobs are rejected.

The technology data blocks are updated.

RUN mode

The user program is processed in RUN mode.

In RUN mode, the programmed Motion Control jobs are cyclically called and processed.

The technology data blocks are updated.

HOLD operating state

Working with breakpoints is not supported when technology objects are used. An overflow of the MC-Servo hereby occurs. This leads to an immediate switch to STOP mode.

In HOLD operating state, events are not initiated and the user program is not executed.

All outputs are disabled or react according to the parameter settings. Outputs supply a configured substitute value or keep the last value output and bring the controlled process to a safe operating state.

When you reach a breakpoint, the CPU executes an implicit restart of the technology object. Homing the technology once again.

Using versions (S7-1500, S7-1500T)

4.1 Overview of versions (S7-1500, S7-1500T)

For S7-1500 Motion Control, a distinction is made between the version of the technology, the technology objects and the Motion Control instructions. The overview shown below includes S7-1500 and S7-1500T. Only one technology version can be operated on a CPU.

When changing to a CPU \geq V1.6, you must change the technology version accordingly. Card replacement from a CPU $<$ V1.6 to a \geq CPU V1.6 is supported. In the TIA Portal, you can use a CPU \geq V1.6 only to work on projects with a correspondingly higher technology version.

There are two ways of changing the technology version:

- Changing the version of the Motion Control instructions

You change the version of the Motion Control instructions in the "Instructions" task card in the folder "Technology > Motion Control > S7-1500 Motion Control".

If the Motion Control instruction version used does not correspond to the compatibility list, the relevant Motion Control instructions are highlighted in red in the program editor.

- Adding a technology object with an alternative version

If a technology object with an alternative version is added in the "Add new object" dialog, the technology version is changed to the alternative version.

The technology objects and Motion Control instructions are only converted to the selected version of the technology during compilation.

The version of a technology object or a Motion Control instruction is indicated in the properties of the technology object, "General > Information" tab, "Version" field.

Compatibility list

The table below shows the compatibility of the technology version with the CPU version:

CPU	Technology	Technology object
V2.8	V5.0	Speed axis V5.0 Positioning axis V5.0 External encoder V5.0 Synchronous axis V5.0 Measuring input V5.0 Output cam V5.0 Cam track V5.0 Cam V5.0 (S7-1500T) Kinematics V5.0 (S7-1500T) Leading axis proxy V5.0 (S7-1500T)
V2.5	V4.0	Speed Axis V4.0 Positioning Axis V4.0 External Encoder V4.0 Synchronous Axis V4.0 Measuring input V4.0 Cam V4.0 Cam track V4.0 Cam V4.0 (S7-1500T) Kinematics V4.0 (S7-1500T)
V2.0, V2.1	V3.0	Speed Axis V3.0 Positioning axis V3.0 External encoder V3.0 Synchronous axis V3.0 Measuring input V3.0 Output cam V3.0 Cam track V3.0 Cam V3.0 (S7-1500T)
V1.6, V1.7, V1.8	V2.0	Speed Axis V2.0 Positioning axis V2.0 External encoder V2.0 Synchronous axis V2.0
V1.0, V1.1, V1.5 ¹	V1.0	Speed Axis V1.0 Positioning axis V1.0 External encoder V1.0

1) Card replacement from a CPU < V1.6 to a CPU ≥ V1.6 is supported.

Parameter "Mode" of the Motion Control instruction "MC_Home"

The "MC_Home.Mode" parameter for S7-1200 Motion Control and S7-1500 Motion Control has been standardized within the framework of technology version V2.0. This results in a new assignment of the parameter values for the "MC_Home.Mode" parameter.

The table below shows a comparison of the "MC_Home.Mode" parameter for technology V1.0 and ≥ V2.0:

MC_Home.HomingMode V1.0	Parameter value	MC_Home.Mode ≥ V2.0
Direct homing (absolute)	0	Direct homing (absolute)
Direct homing (relative)	1	Direct homing (relative)
Passive homing	2	Passive homing (without reset)
Passive homing (with configured home position)	3	Active homing
Active homing	4	Reserved
Active homing (with configured home position)	5	Active homing (with configured home position)
Absolute encoder adjustment (relative)	6	Absolute encoder adjustment (relative)
Absolute encoder adjustment (absolute)	7	Absolute encoder adjustment (absolute)
Passive homing (without reset)	8	Passive homing
Abort passive homing	9	Abort passive homing
-	10	Passive homing (with configured home position)

You can find additional information about the "MC_Home.Mode" parameter in the description of the Motion Control instruction "MC_Home".

Tags of the technology object

Starting from technology version V3.0, all input and output addresses are specified using data type "VREF". This results in the following changes to the tags of the technical object:

Tag of technology object	Changes starting from V3.0
<TO>.Actor.Interface.AddressIn	Data type: VREF
<TO>.Actor.Interface.AddressOut	Data type: VREF
<TO>.Sensor[1..4].Interface.AddressIn	Data type: VREF
<TO>.Sensor[1..4].Interface.AddressOut	Data type: VREF
<TO>.Actor.Interface.EnableDriveOutputAddress	Data type: VREF
<TO>.Actor.Interface.EnableDriveOutputBitNumber	Tag eliminated
<TO>.Actor.Interface.DriveReadyInputAddress	Data type: VREF
<TO>.Actor.Interface.DriveReadyInputBitNumber	Tag eliminated
<TO>.Sensor[1..4].ActiveHoming.DigitalInputAddress	Data type: VREF
<TO>.Sensor[1..4].ActiveHoming.DigitalInputBitNumber	Tag eliminated
<TO>.Sensor[1..4].PassiveHoming.DigitalInputAddress	Data type: VREF
<TO>.Sensor[1..4].PassiveHoming.DigitalInputBitNumber	Tag eliminated
<TO>.PositionLimits_HW.MinInputAddress	Data type: VREF
<TO>.PositionLimits_HW.MinInputBitNumber	Tag eliminated
<TO>.PositionLimits_HW.MaxInputAddress	Data type: VREF
<TO>.PositionLimits_HW.MaxInputBitNumber	Tag eliminated

4.2 Version V5.0 (S7-1500, S7-1500T)

Innovations

Technology version V5.0 contains the following new features:

- The values for position, velocity and angle can be configured with higher resolution.
- In the axis control panel, the dynamic values are retained until the axis control panel is closed.
- In the central operation of the technological modules, the clock synchronization is supported via the active backplane bus.
- The organization block MC-PreInterpolator [OB68] enables isosynchronous processing of Motion Control instructions.
- With a "MC_Stop" job, you can stop an axis and prevent new jobs.
- With a "MC_Home" job, target positions can be set absolutely or relatively.
- With a "MC_Reset" job, alarms in the drive can be acknowledged without a pending error at the technology object.
- Selected bits in control word 1 and control word 2 can be controlled with a "MC_SetAxisSTW" job.
- With a "MC_WriteParameter" job, hardware limit switches can be activated and deactivated.
- The tag "<TO>.VelocitySetpoint" indicates the effective setpoint velocity.
- The tag "<TO>.ModuloCycle" indicates the number of modulo cycles of the setpoint.
- The tag "<TO>.ActualModuloCycle" indicates the number of modulo cycles of the actual value.

Additional innovations for S7-1500T

Technology Version V5.0 contains the following additional improvements:

- The default value of the CPU communication load for the following CPUs was reduced from 50% to 20%:
 - S7-1505SP T/TF
 - S7-1511T/TF
 - S7-1515T/TF
 - S7-1516T/TF
- The default values of the bus clocks are:
 - 4 ms for CPUs 1511T/TF and 1515T/TF
 - 2 ms for CPU 1516T/TF
 - 1 ms for CPU 1517T/TF
- Synchronous operation:
 - With a cross-PLC synchronous operation, a synchronous operation is possible between axes which are located on different CPUs within a project.
 - A cross-PLC synchronous operation can be configured using the leading axis proxy technology object.
 - The actual value extrapolation has been extended.
 - With a "MC_LeadingValueAdditive" job, an additive leading value can be specified for the following axis cyclically to a leading value.
 - With a "MC_GearInPos" job, a subsequent synchronization via leading value distance is possible for gearing.
 - With a "MC_CamIn" job, a subsequent synchronization via leading value distance is possible for camming.
 - The tag "<TO>.StatusSynchronizedMotion.StatusWord" indicates the exceeding of the dynamics limits during synchronization.
 - The tag "<TO>.StatusSynchronizedMotion.WaitingFunctionState" indicates a pending synchronous operation.

- Kinematics:
 - You can configure the predefined kinematics type "SCARA 2D with orientation".
 - A model of the kinematics with the configured zones is displayed in the "Diagnostics" window.
 - It is possible to measure object coordinate systems offline and online using the "Calibration" window.
 - The movement preparation of the kinematics technology object is calculated in the MC-LookAhead [OB97] organization block.
 - A kinematics with a synchronous "point-to-point" motion can be traversed absolutely with a "MC_MoveDirectAbsolute" job.
 - A kinematics with a synchronous "point-to-point" motion can be traversed relatively with a "MC_MoveDirectRelative" job.
 - With a "MC_KinematicsTransformation" job, a forward transformation can be calculated.
 - With a "MC_InverseKinematicsTransformation" job, an inverse transformation can be calculated.
 - With a "MC_TrackConveyorBelt" job, conveyor tracking is possible.

Motion Control instructions

The technology version V5.0 contains the following new Motion Control instructions:

- MC_Stop V5.0
- MC_SetAxisSTW V5.0
- MC_WriteParameter V5.0
- MC_LeadingValueAdditive V5.0
- MC_MoveDirectAbsolute V5.0 (S7-1500T)
- MC_MoveDirectRelative V5.0 (S7-1500T)
- MC_TrackConveyorBelt V5.0 (S7-1500T)
- MC_KinematicsTransformation V5.0 (S7-1500T)
- MC_InverseKinematicsTransformation V5.0 (S7-1500T)

The technology version V5.0 contains the following revised Motion Control instructions:

- MC_Reset V5.0
- MC_Home V5.0
- MC_GearInPos V5.0 (S7-1500T)
- MC_CamIn V5.0 (S7-1500T)

In addition, the technology version V5.0 contains unchanged Motion Control instructions from V4.0:

- MC_Power V5.0
- MC_Halt V5.0
- MC_MoveAbsolute V5.0
- MC_MoveRelative V5.0
- MC_MoveVelocity V5.0
- MC_MoveJog V5.0
- MC_MoveSuperimposed V5.0
- MC_SetSensor V5.0 (S7-1500T)
- MC_MeasuringInput V5.0
- MC_MeasuringInputCyclic V5.0
- MC_AbortMeasuringInput V5.0
- MC_OutputCam V5.0
- MC_CamTrack V5.0
- MC_GearIn V5.0
- MC_PhasingRelative V5.0 (S7-1500T)
- MC_PhasingAbsolute V5.0 (S7-1500T)
- MC_SynchronizedMotionSimulation V5.0 (S7-1500T)

- MC_InterpolateCam V5.0 (S7-1500T)
- MC_GetCamLeadingValue V5.0 (S7-1500T)
- MC_GetCamFollowingValue V5.0 (S7-1500T)
- MC_MotionInVelocity V5.0 (S7-1500T)
- MC_MotionInPosition V5.0 (S7-1500T)
- MC_TorqueAdditive V5.0
- MC_TorqueRange V5.0
- MC_TorqueLimiting V5.0
- MC_GroupInterrupt V5.0 (S7-1500T)
- MC_GroupContinue V5.0 (S7-1500T)
- MC_GroupStop V5.0 (S7-1500T)
- MC_MoveLinearAbsolute V5.0 (S7-1500T)
- MC_MoveLinearRelative V5.0 (S7-1500T)
- MC_MoveCircularAbsolute V5.0 (S7-1500T)
- MC_MoveCircularRelative V5.0 (S7-1500T)
- MC_DefineWorkspaceZone V5.0 (S7-1500T)
- MC_DefineKinematicsZone V5.0 (S7-1500T)
- MC_SetWorkspaceZoneActive V5.0 (S7-1500T)
- MC_SetWorkspaceZoneInactive V5.0 (S7-1500T)
- MC_SetKinematicsZoneActive V5.0 (S7-1500T)
- MC_SetKinematicsZoneInactive V5.0 (S7-1500T)
- MC_DefineTool V5.0 (S7-1500T)
- MC_SetTool V5.0 (S7-1500T)
- MC_SetOcsFrame V5.0 (S7-1500T)

Version-based UDT names

The following table shows the version-based UDT names for the control words and status words of the SIEMENS telegrams 10x:

UDT name < V4.0	UDT name ≥ V4.0	WORD data type
PD_STW1	PD_STW1_611Umode	Control word 1 (STW1)
PD_STW2	PD_STW2_611Umode	Control word 2 (STW2)
PD_ZSW1	PD_ZSW1_611Umode	Status word 1 (ZSW1)
PD_ZSW2	PD_ZSW2_611Umode	Status word 2 (ZSW2)

If you switch from a technology version < V4.0 to ≥ V4.0 or vice versa, an error occurs during the compilation. You have to adapt the UDT names manually.

4.3 Version V4.0 (S7-1500, S7-1500T)

Innovations

Technology Version V4.0 contains the following new features:

- Exchange of torque data with the drive in the technological units of the technology object.
 - Additive setpoint torque
 - Current actual torque
 - Permissible torque range
- Extension of the data structure of the positioning axis and synchronous axis for using technology object kinematics
- Use of optimized data blocks (drive/encoder connection)

Additional innovations for S7-1500T

Technology Version V4.0 contains the following additional features:

- Kinematic technology object (S7-1500T)
- Motion specification via "MotionIn" instructions (S7-1500T)
- Direct synchronous setting with "MC_CamIn" V4.0 (S7-1500T)

Motion Control instructions

Technology Version V4.0 contains the following Motion Control instructions:

- MC_Power V4.0
- MC_Reset V4.0
- MC_Home V4.0
- MC_Halt V4.0
- MC_MoveAbsolute V4.0
- MC_MoveRelative V4.0
- MC_MoveVelocity V4.0
- MC_MoveJog V4.0
- MC_MoveSuperimposed V4.0
- MC_SetSensor V4.0 (S7-1500T)
- MC_MeasuringInput V4.0
- MC_MeasuringInputCyclic V4.0
- MC_AbortMeasuringInput V4.0
- MC_OutputCam V4.0
- MC_CamTrack V4.0

- MC_GearIn V4.0
- MC_GearInPos V4.0 (S7-1500T)
- MC_PhasingAbsolute V4.0 (S7-1500T)
- MC_PhasingRelative V4.0 (S7-1500T)
- MC_CamIn V4.0 (S7-1500T)
- MC_SynchronizedMotionSimulation V4.0 (S7-1500T)
- MC_InterpolateCam V4.0 (S7-1500T)
- MC_GetCamFollowingValue V4.0 (S7-1500T)
- MC_GetCamLeadingValue V4.0 (S7-1500T)
- MC_MotionInVelocity V4.0 (S7-1500T)
- MC_MotionInPosition V4.0 (S7-1500T)
- MC_TorqueAdditive V4.0
- MC_TorqueRange V4.0
- MC_TorqueLimiting V4.0
- MC_GroupInterrupt V4.0 (S7-1500T)
- MC_GroupContinue V4.0 (S7-1500T)
- MC_GroupStop V4.0 (S7-1500T)
- MC_MoveLinearAbsolute V4.0 (S7-1500T)
- MC_MoveLinearRelative V4.0 (S7-1500T)
- MC_MoveCircularAbsolute V4.0 (S7-1500T)
- MC_MoveCircularRelative V4.0 (S7-1500T)
- MC_DefineWorkspaceZone V4.0 (S7-1500T)
- MC_DefineKinematicsZone V4.0 (S7-1500T)
- MC_SetWorkspaceZoneActive V4.0 (S7-1500T)
- MC_SetWorkspaceZoneInactive V4.0 (S7-1500T)
- MC_SetKinematicsZoneActive V4.0 (S7-1500T)
- MC_SetKinematicsZoneInactive V4.0 (S7-1500T)
- MC_DefineTool V4.0 (S7-1500T)
- MC_SetTool V4.0 (S7-1500T)
- MC_SetOcsFrame V4.0 (S7-1500T)

Version-based UDT names

The following table shows the version-based UDT names for the control words and status words of the SIEMENS telegrams 10x:

UDT name <V4.0	UDT name ≥V4.0	WORD data type
PD_STW1	PD_STW1_611Umode	Control word 1 (STW1)
PD_STW2	PD_STW2_611Umode	Control word 2 (STW2)
PD_ZSW1	PD_ZSW1_611Umode	Status word 1 (ZSW1)
PD_ZSW2	PD_ZSW2_611Umode	Status word 2 (ZSW2)

If you switch from a technology version <V4.0 to ≥V4.0 or vice versa, an error occurs during the compilation. You have to adapt the UDT names manually.

4.4 Version V3.0 (S7-1500, S7-1500T)

Innovations

Technology Version V3.0 contains the following new features:

- Measuring input technology object
- Output cam technology object
- Cam track technology object
- Force/torque limiting
- Fixed stop detection
- Axis type virtual axis
- MC-PreServo [OB67] and MC-PostServo [OB95]
- Technology CPU S7-1500T

Additional innovations for S7-1500T

Technology Version V3.0 contains the following additional improvements:

- Cam technology object (S7-1500T)
- Gearing with "MC_GearInPos" (S7-1500T)
- Camming with "MC_CamIn" (S7-1500T)
- Using multiple encoders (S7-1500T)

Motion Control instructions

Technology Version V3.0 contains the following Motion Control instructions:

- MC_Power V3.0
- MC_Reset V3.0
- MC_Home V3.0
- MC_Stop V3.0
- MC_MoveAbsolute V3.0
- MC_MoveRelative V3.0
- MC_MoveVelocity V3.0
- MC_MoveJog V3.0
- MC_MoveSuperimposed V3.0
- MC_SetSensor V3.0 (S7-1500T)
- MC_MeasuringInput V3.0
- MC_MeasuringInputCyclic V3.0
- MC_AbortMeasuringInput V3.0
- MC_OutputCam V3.0
- MC_CamTrack V3.0
- MC_GearIn V3.0
- MC_GearInPos V3.0 (S7-1500T)
- MC_PhasingAbsolute V3.0 (S7-1500T)
- MC_PhasingRelative V3.0 (S7-1500T)
- MC_CamIn V3.0 (S7-1500T)
- MC_SynchronizedMotionSimulation V3.0 (S7-1500T)
- MC_InterpolateCam V3.0 (S7-1500T)
- MC_GetCamFollowingValue V3.0 (S7-1500T)
- MC_GetCamLeadingValue V3.0 (S7-1500T)
- MC_TorqueLimiting V3.0

4.5 Version V2.0 (S7-1500, S7-1500T)

Innovations

Technology Version V2.0 contains the following new features:

- Synchronous axis technology object
- Gearing with "MC_GearIn"
- Superimposed positioning with "MC_MoveSuperimposed"
- Standardization of the "MC_Home.Mode" parameter for S7-1200 Motion Control and S7-1500 Motion Control
- Simulation mode
- Support of safety functions of the drive

Motion Control instructions

Technology Version V2.0 contains the following Motion Control instructions:

- MC_Power V2.0
- MC_Reset V2.0
- MC_Home V2.0
- MC_Halt V2.0
- MC_MoveAbsolute V2.0
- MC_MoveRelative V2.0
- MC_MoveVelocity V2.0
- MC_MoveJog V2.0
- MC_MoveSuperimposed V2.0
- MC_GearIn V2.0

4.6 Version V1.0 (S7-1500, S7-1500T)

Motion Control instructions

Technology Version V1.0 contains the following Motion Control instructions:

- MC_Power V1.0
- MC_Reset V1.0
- MC_Home V1.0
- MC_Halt V1.0
- MC_MoveAbsolute V1.0
- MC_MoveRelative V1.0
- MC_MoveVelocity V1.0
- MC_MoveJog V1.0

4.7 Changing a technology version (S7-1500, S7-1500T)

Before you can access all the benefits of a new technology version, you need to change the technology version for existing projects.

Changing a technology version

To change the technology version, follow these steps:

1. Replace the CPU in the project with a CPU with an appropriate higher version.
2. Open the program editor (e.g. by opening the OB1).

The technology objects and Motion Control instructions are highlighted in red after the CPU is replaced.

3. In the "Instructions" task card, select the appropriate higher technology version in the "Technology > Motion Control" folder.
4. Save and compile the project.

The version of the technology objects and Motion Control instructions is changed to the appropriate higher technology version during compilation of the project.

Pay attention to any error information that is displayed during compilation. Deal with the causes of the errors indicated.

5. Check the configuration of the technology objects.

Resetting the "Mode" parameter of the Motion Control instruction "MC_Home"

When the technology version is changed from V1.0 to \geq V2.0, the "MC_Home.HomingMode" parameter (V1.0) is renamed to "MC_Home.Mode" (\geq V2.0). The assignment of the parameter values is changed as well.

To reset the "MC_Home.Mode" parameter (V2.0), follow these steps:

1. To change the technology version, follow the instructions given above.

When compiling the project, the "MC_Home.HomingMode" parameter (V1.0) is renamed to "MC_Home.Mode" (\geq V2.0):

- The assignment of the parameter values is changed. A comparison of the "MC_Home.Mode" parameter for technology versions V1.0 and \geq V2.0 is available in section Version overview (Page 32).

You can find additional information about the "MC_Home.Mode" parameter in the description of the Motion Control instruction "MC_Home".

- The value configured at the "MC_Home.HomingMode" parameter (V1.0) is lost. As a note on renaming, the following text is entered as the parameter value in the "MC_Home.Mode" parameter (\geq V2.0).

"The interface has changed. You can find additional information in the description of the Motion Control instruction "MC_Home".

- There is a message in the "Info > Compile" tab in the Inspector window stating that the operand has the wrong data type.

2. Change the value of the "MC_Home.Mode" parameter (\geq V2.0) in your user program according to the new assignment.
3. Save and compile the project.

4.8 Replacing devices (S7-1500, S7-1500T)

You can replace an S7-1500 for an S7-1500T of the same design and vice versa. The behavior with respect to functions and the existing configuration is different depending on what is being replaced.

- S7-1500 ⇒ S7-1500T

The functions of the S7-1500 are expanded to include additional parameters for the extended functions of the S7-1500T. The additional parameters are preassigned with default values and must be configured appropriately.

- S7-1500T ⇒ S7-1500

- Extended functions are only supported by an S7-1500T and are no longer available after a replacement with S7-1500.
- Unsupported function blocks are marked.
- Unsupported technology objects are displayed in an error message after compilation and must be deleted.

Configuring (S7-1500, S7-1500T)

5.1 Adding and configuring drives in the device configuration (S7-1500, S7-1500T)

Adding and configuring a drive is described in the following section with the example of a SINAMICS S120 drive. If you use a SINAMICS V90 PN or a SINAMICS drive with Startdrive, you can find additional information in the following documentation.

Using SINAMICS V90 PN

To add and configure a SINAMICS V90 PN drive in the TIA Portal, you need the Hardware Support Package HSP 0185 (SINAMICS V90 PN). Information on configuring a SINAMICS V90 PN drive with SIMATIC S7-1500 in the TIA Portal is available in the Getting Started "SIMATIC/SINAMICS First Steps SINAMICS V90 PN on S7-1500 Motion Control":

<https://support.industry.siemens.com/cs/document/109739497>
(<https://support.industry.siemens.com/cs/ww/en/view/109739497>)

Using Startdrive

If you use a SINAMICS drive with Startdrive, you can find additional information in the hardware catalog in the "Drives & Starter" folder. For additional information on connecting via Startdrive, refer to:

- "Getting Started SINAMICS S120 in the Startdrive":
<https://support.industry.siemens.com/cs/document/109747452>
(<https://support.industry.siemens.com/cs/ww/en/view/109747452>)
- Application example "Configuring an S120 with Startdrive":
<https://support.industry.siemens.com/cs/ww/en/view/109743270>
(<https://support.industry.siemens.com/cs/ww/en/view/109743270>)

Drives compatibility list

In the appendix (Page 176) you can find an overview of drives that can be interconnected with an S7-1500 CPU.

5.1.1 Adding and configuring PROFINET IO drives (S7-1500, S7-1500T)

Adding and configuring a PROFINET IO drive is described below with the example of a SINAMICS S120 drive. Adding and configuring other PROFINET IO drives may differ from the description in certain respects.

When you use a S7-1500C CPU you can use the inputs/outputs of the CPU as interface to the drive.

Requirements

- The SIMATIC S7-1500 device is created in the project.
- The desired drive can be selected in the hardware catalog.

If the drive is not available in the hardware catalog, you must install the drive in the "Options" menu as a device description file (GSD).

Adding a drive and telegram in the device configuration

1. Open the device configuration and change to the network view.
2. In the hardware catalog, open the folder "Additional field devices > PROFINET IO > Drives > Siemens AG > SINAMICS".
3. Select the desired drive with the desired version, then drag it to the network view.
4. Assign the drive to the PROFINET interface of the CPU.
5. Open the drive in the device view.
6. Drag a Drive Object (DO) and a telegram from the hardware catalog and drop it onto a slot of the device overview of the drive.
7. Make sure that the order of the telegrams in the device configuration and in the drive parameter assignment are identical.

Depending on the version of the SINAMICS S120 drive, select "DO with telegram X", or "DO Servo" and a "Telegram X" for the telegram.

Information on suitable telegrams can be found in the chapter "PROFIdrive telegrams" of the documentation "S7-1500/S7-1500T Axis functions (<https://support.industry.siemens.com/cs/ww/en/view/109766462>)".

Repeat step 6, if you want to add another drive and another standard telegram.

Activating isochronous mode of the drive in the device configuration

PROFINET drives can always be operated in isochronous mode or clock synchronized mode. Isochronous mode, however, increases the quality of the closed loop position control of the drive and is therefore recommended for drives such as SINAMICS S120.

To control the drive in isochronous mode, follow these steps:

1. Open the device view of the drive.
2. In the properties window, select the tab "PROFINET interface [X1] > Advanced options > Isochronous mode".
3. Select the "Isochronous mode" check box in this tab.

The entry for the telegram also has to be selected for isochronous mode in the detailed view.

Interconnect the port of the CPU with the port of the drive

1. Open the topology view in the device configuration.
2. Interconnect the port of the drive as in the real configuration with the port of the CPU. At the same time, note the rules for topology configuration.

Configure the CPU as the sync master and set isochronous mode

1. Select the device view of the CPU.
2. In the Properties window, select the tab "PROFINET interface [X1] > Advanced options > Real-time settings > Synchronization".
3. Select "Sync master" from the "Synchronization role" drop-down list.
4. Click the "Domain settings" button.
5. Open the "Domain Management > Sync Domains" tab and set the desired "Send clock" (isochronous clock).

Select drive in the configuration of the technology object

1. Add a new technology object axis, or open the configuration of an existing axis.
2. Open the configuration "Hardware interface > Drive".
3. Select from the "PROFIdrive" entry in the "Drive type" drop-down list.
4. Select the Drive Object of the PROFINET drive from the "Drive" list.

For information on how to add a technology object, refer to the section "Add technology object (Page 60)".

Result

The technology object is connected to the drive and the "MC-Servo" organization block can be checked / configured.

The telegram of the configured drive is assigned to the "PIP OB Servo" process image.

Checking/configuring the properties of the "MC-Servo"

1. Open the "Program blocks" folder in the project navigator.
2. Select the "MC-Servo" organization block.
3. Select the "Properties" command in the shortcut menu.
4. Select the "Cycle time" entry in the area navigation.
5. The option "Synchronous to the bus" must be selected in the dialog box.
6. A "PROFINET IO system" must be selected in the "Source of the send clock" drop-down list.
7. The application cycle of "MC-Servo" must correspond to the send clock of the bus or be reduced by an integral factor relative to the send clock of the bus.

Result

The PROFINET IO drive is configured in such a way that it can be controlled in isochronous mode in the PROFINET IO network.

The properties of the SINAMICS drive must be configured according to the configuration of the axis with the STARTER software or SINAMICS Startdrive.

Checking isochronous mode on the drive

If the configuration sequence described above is not adhered to during configuration of the axis, and drive-specific errors occur when the project is compiled, the setting for isochronous mode on the drive must be checked.

1. Open the device view of the drive.
2. Select standard telegram in the device overview.
3. Select the properties dialog "General > I/O Addresses".
4. The following settings apply for the input and output addresses:
 - "Isochronous mode" is enabled.
 - "MC-Servo" must be selected for the "Organization block".
 - "PIP OB Servo" must be selected for the "Process image".

See also

Add technology object (Page 60)

5.1.2 Adding and configuring PROFIBUS DP drives (S7-1500, S7-1500T)

Adding and configuring a PROFIBUS drive is described below with the example of a SINAMICS S120 drive. Adding and configuring other PROFIBUS drives may differ from the description in certain respects.

When you use a S7-1500C CPU you can use the inputs/outputs of the CPU as interface to the drive.

Requirements

- The SIMATIC S7-1500 device is created in the project.
- The desired drive can be selected in the hardware catalog.

If the drive is not available in the hardware catalog, you must install the drive in the "Options" menu as a device description file (GSD).

Adding a drive and telegram in the device configuration

1. Open the device configuration and change to the network view.
2. In the hardware catalog, open the folder "Additional Field Devices > PROFIBUS DP > Drives > Siemens AG > SINAMICS".
3. Select the folder of the desired drive with the desired version, then drag the drive object to the network view.
4. Assign the drive to the PROFIBUS interface of the CPU.
5. Open the drive in the device view.
6. Drag-and-drop a telegram from the hardware catalog onto a slot in the device overview of the drive.

Information on suitable telegrams can be found in the chapter "PROFIdrive telegrams" of the documentation "S7-1500/S7-1500T Axis functions (<https://support.industry.siemens.com/cs/ww/en/view/109766462>)".

If you want to add another drive and another telegram to the device overview, use the "Axis disconnect" in the hardware catalog.

Activating isochronous mode of the drive in the device configuration

PROFIBUS drives can be operated in cyclic mode or isochronous mode. Isochronous mode, however, increases the quality of the position control of the drive.

If you want to control the drive in isochronous mode, follow these steps:

1. Open the device view of the drive.
2. In the properties dialog, select the tab "General > Isochronous Mode".
3. Select the "Synchronize DP slave to constant DP bus cycle time" check box .

Setting isochronous mode

1. Select the network view.
2. Select the DP master system.
3. In the properties dialog, select the tab "General > Constant bus cycle time".
4. Select the desired "Constant DP bus cycle times".

Select drive in the configuration of the technology object

1. Add a new technology object axis, or open the configuration of an existing axis.
2. Open the configuration "Hardware interface > Drive".
3. Select from the "PROFIdrive" entry in the "Drive type" drop-down list.
4. Select the telegram of the PROFIBUS drive from the "Drive" list.

For information on how to add a technology object, refer to the section "Add technology object (Page 60)".

Result

The technology object is connected to the drive and the "MC-Servo" organization block can be checked/configured.

The telegram of the configured drive is assigned to the "PIP OB Servo" process image.

Checking/configuring the properties of the "MC-Servo"

1. Open the "Program blocks" folder in the project navigator.
2. Select the "MC-Servo" organization block.
3. Select the "Properties" command in the shortcut menu.
The "MC-Servo" dialog opens.
4. Select the "Synchronous to the bus" option under "General > Cycle time".
5. In the "Distributed I/O" drop-down list, select a "PROFIBUS DP-System".

The application cycle of "MC-Servo" must correspond to the send clock of the bus or be reduced by an integral factor relative to the send clock of the bus.

You can select a drive connected to the CPU via a communications processor/communications module (CP/CM) in the configuration of the technology object. You cannot select the DP master system of the CP/CM as the source clock for MC-Servo [OB91].

Result

The PROFIBUS DP drive is configured in such a way that it can be controlled in isochronous mode in the PROFIBUS network.

The properties of the SINAMICS drive must be configured according to the configuration of the axis with the STARTER software or SINAMICS Startdrive.

Checking isochronous mode on the drive

If the configuration sequence described above is not adhered to during configuration of the axis, and drive-specific error occurs when the project is compiled, isochronous mode can be checked on the drive.

1. Open the device view of the drive.
2. Select the entry of the telegram in the device overview.
3. Select the properties dialog "General > I/O Addresses".
4. The following settings apply for the input and output addresses:
 - "MC-Servo" must be selected for the "Organization block".
 - "PIP OB Servo" must be select the "Process image".

See also

Add technology object (Page 60)

5.1.3 Adding and configuring drives with analog connections (S7-1500, S7-1500T)

A description is provided below of how to add and configure a drive with an analog drive connection and an encoder. The connection is made, for example, as a positioning axis with an incremental encoder and using a technology module in the rack of the CPU.

When you use a S7-1500C CPU you can use the inputs/outputs of the CPU as interface to the drive.

Requirements

The SIMATIC S7-1500 device is created in the project.

Adding and configuring an analog output module in the device configuration

1. Open the device configuration of the CPU.
2. Select an analog output module from the hardware catalog and drag the module to the rack of the CPU.
3. Select the analog output module in the device view.
4. Open the "General" tab in the properties dialog and select there "Name of the Analog Output Module > I/O Addresses".
5. Enter the desired start address.
6. In the properties dialog, select the tab "General > IO Tags".
7. Enter the tag name for the desired analog output.

Adding and configuring a technology module

1. Switch to the device view of the CPU.
2. In the hardware catalog, open the folder "Technology module > Count > TM Count 2X24V".
3. Drag the counter module to a free slot in the rack.
 - Technology version \leq V4.0: When in use in the rack of the CPU, the technology module cannot be operated in isochronous mode.
 - Technology version \geq V5.0: The clock synchronization is supported by the central operation of the technological modules via the active backplane bus.
4. Select the technology module in the device view.
5. In the properties dialog, open the "General" tab and select "TM Count 2x24V > Channel x > Operating mode" of the channel to be used.
6. Select "Position input for Motion Control" option for "Selection of the operating mode for the channel".
7. Under "Module parameters", adapt the parameters of the incremental encoder (steps per revolution = increments per revolution).

Selecting the drive and encoder in the configuration of the technology object

1. Add a new positioning axis/synchronous axis technology object, or open the configuration of an existing positioning axis/synchronous axis.
2. Open the configuration "Hardware interface > Drive".
3. Select "Analog drive connection" from the "Drive type" drop-down list.
4. Select the previously defined tag name of the analog output from the "Analog output" list.
5. Open the configuration "Hardware interface > Encoder".
6. Select the "Encoder" entry from the "Data connection" drop-down list.
7. Select the channel of the incremental encoder from the "encoder" list under "Local modules".
8. Open the configuration "Hardware interface > Data exchange with encoder > Fine resolution" and enter the value "0" for "Bits in Gx_XIST1".

For information on how to add a technology object, refer to the section "Add technology object (Page 60)".

Result

The analog drive connection and the encoder connection are configured.

The analog addresses and the addresses of the TM module are assigned to the process image "PIP OB Servo".

Checking the encoder connection/drive connection

The encoder data are applied to the position control cycle clock. If in doubt, check the following settings:

1. Switch to the device view of the CPU.
2. Select the module technology.
3. Open the properties dialog "Basic Parameters > I/O Addresses".
4. The following settings apply for the input and output addresses:
 - "MC-Servo" must be selected for the "Organization block".
 - "PIP OB Servo" must be select the "Process image".
5. Select the analog module.
6. Open the properties dialog "Name of the Analog Module > I/O Addresses".
7. The settings from Step 4 apply for the input and output addresses

See also

Add technology object (Page 60)

5.2 Configuration basics (S7-1500, S7-1500T)

5.2.1 Add technology object (S7-1500, S7-1500T)

The following describes how to add a technology object in the project tree.

Requirement

- A project with a CPU S7-1500 has been created.
- For the output cam, cam track, measuring input technology objects:
A speed axis, positioning axis, synchronous axis or external encoder technology object is created in the project.

Procedure

To add a technology object, follow these steps:

1. Open the CPU's folder in the project navigator.
2. Open the "Technology Objects" folder.
3. Double-click "Add new object".

The "Add new object" dialog opens.

4. Select the required technology object. You can infer the function of the technology object from the displayed description.
5. If you add output cams, cam tracks, measuring inputs to a technology object, select the higher-level technology object in the "Axis or external encoder that is to be assigned".
6. In the "Name" input field, adapt the name to your requirements.
7. To change the suggested data block number, select the "Manual" option.
8. To add your own information about the technology object, click "Additional information".
9. To open the configuration after adding the technology object, select the "Add new and open" check box.
10. To add the technology object, click "OK".

Result

The new technology object was created and created in the "Technology objects" folder in the project tree.

If the "MC-Servo" and "MC-Interpolator" organizational units were not yet available, they were added.

5.2.2 Copy technology object (S7-1500, S7-1500T)

You can copy a technology object in the following ways:

- Copying a technology object within a CPU
- Copying a technology object from a CPU S7-1500 to a CPU S7-1500T

Additional parameters for the extended functions are preset with default values. You must configure them appropriately.

- Copying a technology object from a CPU S7-1500T to a CPU S7-1500

Additional parameters, which are not supported by the CPU S7-1500, are reset to the default values.

When you copy a technology object that has lower-level technology objects such as output cams, cam tracks or measuring inputs, the lower-level technology object are also copied.

The following describes how to copy a technology object within a CPU. The procedure also applies accordingly to the other copying methods mentioned.

Requirement

- A project with a CPU S7-1500 has been created.
- You have created an technology object in the project.

Procedure

To copy a technology object, follow these steps:

1. Open the CPU's folder in the project navigator.
2. Open the "Technology Objects" folder.
3. If necessary, open the higher-level technology object.
4. Select the technology object to be copied.
5. Select "Copy" in the shortcut menu.
6. Select the "Technology objects" folder or the higher-level technology object.
7. Select "Paste" in the shortcut menu.

Result

The selected technology object, including lower-level technology objects, has been copied and created in the "Technology objects" folder of the project tree.

5.2.3 Delete technology object (S7-1500, S7-1500T)

You can delete technology objects in the project tree.

When you delete a technology object that has lower-level technology objects such as output cams, cam tracks or measuring inputs, the lower-level technology object are also deleted.

Requirement

- A project with a CPU S7-1500 has been created.
- You have created an technology object in the project.

Procedure

To delete a technology object, follow these steps:

1. Open the CPU's folder in the project navigator.
2. Open the "Technology objects" folder.
3. If necessary, open the higher-level technology object.
4. Select the technology object to be deleted.
5. Select the "Delete" command in the shortcut menu.

The "Confirm delete" dialog is opened.

6. To delete the technology object, click "Yes".

Result

The selected technology object has been deleted.

See also

Compare values (Page 63)

5.2.4 Working with the configuration editor (S7-1500, S7-1500T)



You configure the properties of a technology object in the configuration window. To open the configuration window of the technology object in the project view, follow these steps:

1. Open the device "Technology objects" group in the project navigator.
2. Select the technology object and double-click on "Configuration".

The configuration is divided into categories which depend on the object type, for example, basic parameters, hardware interface, extended parameters.

Configuration editor icons

Icons in the area navigation of the configuration show additional details about the status of the configuration:

Symbol	Description
	The configuration contains default values and is complete. The configuration contains only default values. With these default values you can use the technology object without additional changes.
	The configuration contains user-defined or automatically adapted values and is complete. All input fields of the configuration contain valid values and at least one preset value has been changed.
	The configuration is incomplete or incorrect. At least one input field or drop-down list contains an invalid value. The corresponding field or the drop-down list is displayed on a red background. Click the field shows you the roll-out error message that indicates the cause of error.

5.2.5 Compare values (S7-1500, S7-1500T)

If an online connection to the CPU is available, the "Monitor all" function  appears in the configuration of the technology object.

The "Monitor all" function provides the following options:

- Comparison of configured start values of the project with the start values in the CPU and the actual values
- Direct editing of actual values and the start values of the project
- Immediate detection and display of input errors with suggested corrections
- Backup of actual values in the project
- Transfer of start values of the project to the CPU as actual values

Note







Differences between online and offline values

By adding or deleting technology objects that have a connection to other technology objects, such as cams, cam tracks, measuring inputs or synchronized axes, differences can occur when online and offline values are compared. These differences can be eliminated by re-compiling the project and then uploading it to the CPU.

Icons and operator controls

If there is an online connection to the CPU, the actual values are displayed at the parameters.

In addition to the actual values of the parameters, the following symbols appear:

Symbol	Description
	Start value in CPU matches the configured start value in project
	Start value in CPU does not match the configured start value in project
	Software error in lower-level component: The online and offline versions differ in at least one lower-level software component.
	The comparison of the Start value in CPU with the configured start value in project cannot be performed.
	Comparison of the online and offline values is not advisable.
	Use this button to show the start value of the CPU and the start value of the project for the respective parameter.

You can change the start value of the CPU directly and then download it to the CPU. For directly editable parameters, the actual value can also be changed and the change will be transferred directly to the CPU.

5.3 Configuring technological modules and onboard I/O for Motion Control (S7-1500, S7-1500T)

Use with Motion Control

You can use technology functions of technology modules and the onboard I/Os of the CPUs listed below with Motion Control technology objects. To use the technology functions for Motion Control, specific parameters of the I/O configuration and parameters of the configuration of the technology object must be configured accordingly. Which parameters are relevant for the function is described below. You can set additional parameters that are not listed here. The description of the parameters is found in the documentation of the respective technology module or the respective CPU.

The following technology modules support Motion Control functionalities:

S7-1500/ET 200MP	ET 200 SP	Possible applications
TM Count 2x24V (Page 67) ¹⁾	TM Count 1x24V (Page 67) ¹⁾	<ul style="list-style-type: none"> Position detection for homing with zero mark via PROFIdrive telegram
TM PosInput 2 (Page 69) ¹⁾	TM PosInput 1 (Page 69) ¹⁾	<ul style="list-style-type: none"> Position detection for homing with zero mark via PROFIdrive telegram
TM Timer DIDQ 16x24V (Page 72) ²⁾	TM Timer DIDQ 10x24V (Page 72) ²⁾	<ul style="list-style-type: none"> Output of output cam and cam track for time-controlled switching ²⁾ Time-based position detection via measuring input (time stamp recording) ²⁾
–	TM Pulse 2x24V (Page 73) ¹⁾	<ul style="list-style-type: none"> Drive connection using PWM (pulse width modulation)
TM PTO 4 (Page 74) ³⁾	–	<ul style="list-style-type: none"> Drive connection via PTO (Pulse Train Output) Position detection with measuring input via PROFIdrive telegram ²⁾

¹⁾ Automatic data exchange for encoder values is supported

²⁾ Isochronous mode required

³⁾ Automatic data exchange for drive and encoder values is supported

The following CPUs support Motion Control functionalities through their onboard I/O:

CPU	Possible applications
CPU 1511C-1 PN/CPU 1512C-1 PN (Page 77) ¹⁾	<ul style="list-style-type: none"> • Drive connection via PTO (Pulse Train Output) • Drive connection using PWM (pulse width modulation) • Encoder connection via HSC (High-speed counter) • Position detection with measuring input via PROFIdrive telegram ²⁾
SIMATIC Drive Controller (Page 83)	<ul style="list-style-type: none"> • Output of output cam and cam track for time-controlled switching ²⁾ • Time-based position detection via measuring input (time stamp recording) ²⁾

¹⁾ Automatic data exchange for drive and encoder values is supported

²⁾ Isochronous mode required

Isochronous mode

Isochronous mode is required for use with a measuring input, output cam or cam track.

Technology modules can be used centrally or distributed in the system. Clock synchronization is supported in distributed operation with suitable PROFINET interface modules and in the centralized operation with the active backplane bus.

The onboard technology I/Os (X142) of the SIMATIC Drive Controller support clock synchronization.

Automatic data exchange for drive and/or encoder values

By selecting the check box for automatic data exchange, the drive and encoder parameters are automatically applied in the CPU.

Alternatively, you can manually match, by drive and encoder type, the parameters described and identified in the following table.

The following types are available for automatic data exchange:

- **Offline**





Select the check box if you want to transfer the offline values of the drive or encoder to the configuration of the technology object in the project.



- **Online**

Select the check box if you want to transfer the effective values online in the drive or encoder to the CPU during runtime. The drive and encoder parameters are transferred from the bus after the (re)initialization of the technology object and (re)start of the drive, encoder or the CPU.

5.3.1 TM Count 1x24V/TM Count 2x24V (S7-1500, S7-1500T)

For use with Motion Control, the following parameters must be configured:

Configuration	
Technology module TM Count 1x24V/TM Count 2x24V	Technology object  Axis and  external encoder
TM Count 1x24V/TM Count 2x24V > Channel 0/1 > Operating mode	–
Select "Position detection for Motion Control technology object" mode	
TM Count 1x24V/TM Count 2x24V > Channel 0/1 > Module parameters	Hardware interface > Encoder
–	Select "Encoder" data connection and the channel configured for Motion Control on the technology module as encoder
Signal type • Incremental encoder	Select encoder type corresponding to configuration for technology module • Incremental ¹⁾
–	 Axis: Hardware interface > Data exchange with encoder  External encoder: Hardware interface > Data exchange Telegram "DP_TEL83_STANDARD" is automatically selected after the selection of the encoder. Clear the check box "Automatic data exchange for encoder values (online)" Select the check box "Automatic data exchange for encoder values (offline)" If the check box is cleared, you can manually match the parameters described and identified in this table. Select rotary or linear measuring system type ¹⁾
Signal evaluation • Single • Double • Quadruple	Select fine resolution corresponding to configuration on the technology module ¹⁾ • 0 = Single • 1 = Double • 2 = Quadruple
• Rotary type: Enter increments per revolution • Linear type: Configuration not relevant	• Rotary type: Enter increments per revolution corresponding to configuration at technology module (1:1) ¹⁾ • Linear type: Enter distance between increments ¹⁾



Configuration	
Technology module	Technology object
TM Count 1x24V/TM Count 2x24V	 Axis and external encoder
-	 Axis: Hardware interface > Data exchange with the drive
<ul style="list-style-type: none"> Rotary type: Enter reference speed corresponding to configuration for technology object (1:1) Linear type: Configuration not relevant 	Enter reference speed
-	Homing
Select the homing signal for homing mark 0: <ul style="list-style-type: none"> Signal N of the incremental encoder DIO 	Use the homing mode "Use zero mark via PROFIdrive telegram". TM Count 1x24V as of V2.0 The states of the digital inputs are displayed in the operating mode "Position detection for Motion Control technology object" in the process image. The following bits are used for this purpose: <ul style="list-style-type: none"> STS_DI0 (Status of DI0): ZSW2_ENC.Reserved_Bit11 STS_DI1 (Status of DI1): ZSW2_ENC.Reserved_Bit10 STS_DI2 (Status of DI2): ZSW2_ENC.Reserved_Bit8 To select one of the digital inputs use, for example, a PLC tag of the data type "PD_TEL83_IN" with the input start address of the desired channel of the module. The status word "ZSW2_ENC" and the named bits can be found within the created tag structure.
TM Count 2x24V > I/O addresses	-
The organization block ("MC-Servo") and the process image ("TPA OB Servo") are selected automatically for the input and output addresses by selecting the channel in the encoder configuration at the technology object.	
Process image: PIP OB servo	





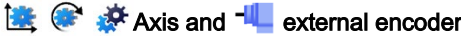

1) Parameters are automatically applied when "Automatic data exchange for encoder values (offline)" is selected

"-" No configuration for technology module/technology object is required for these parameters

5.3.2 TM PosInput 1/TM PosInput 2 (S7-1500, S7-1500T)

For use with Motion Control, the following parameters must be configured:

Configuration	
Technology module TM PosInput 1 / TM PosInput 2	Technology object  Axis and external encoder
TM PosInput 1/2 > Channel 0/1 > Operating mode	–
Select "Position detection for Motion Control technology object" mode	
TM PosInput 1/2 > Channel 0/1 > Module parameters You set the parameters for the encoder signals of the channel under "Module parameters" in the "Position input for Motion Control" mode. The parameters must be set depending on the encoder used. The configuration of the encoder is required for use with an SSI absolute encoder. Information on the configuration is available in the documentation for the respective technology module.	Hardware interface > Encoder
–	Select "Encoder" data connection and the channel activated and configured as encoder on the technology module
Signal type <ul style="list-style-type: none"> • Incremental encoder • Absolute encoder 	Select encoder type corresponding to configuration for technology module: <ul style="list-style-type: none"> • Incremental ¹⁾ • Absolute/Cyclic absolute
–	 Axis: Hardware interface > Data exchange with encoder  External encoder: Hardware interface > Data exchange Telegram "DP_TEL83_STANDARD" is automatically selected after the selection of the encoder. Clear the check box "Automatic data exchange for encoder values (online)" Select the check box "Automatic data exchange for encoder values (offline)" If the check box is cleared, you can manually match the parameters described and identified in this table. Select rotary or linear measuring system type ¹⁾

Configuration	
Technology module TM PosInput 1 / TM PosInput 2	Technology object    Axis and  external encoder
Signal evaluation <ul style="list-style-type: none"> • Single • Double • Quadruple 	Select fine resolution corresponding to configuration on the technology module ¹⁾ <ul style="list-style-type: none"> • Incremental encoder: <ul style="list-style-type: none"> – 0 = Single – 1 = Double – 2 = Quadruple • Absolute encoder: <ul style="list-style-type: none"> – 0 = Single
<ul style="list-style-type: none"> • Rotary type: Enter increments per revolution • Linear type: Configuration not relevant 	<ul style="list-style-type: none"> • Rotary type: Enter increments per revolution corresponding to configuration at technology module (1:1) ¹⁾ • Linear type: Enter distance between increments ¹⁾
–	   Axis: Hardware interface > Data exchange with the drive
<ul style="list-style-type: none"> • Rotary type: Enter reference speed corresponding to configuration for technology object (1:1) • Linear type: Configuration not relevant 	Enter reference speed
–	Homing
Select the homing signal for homing mark 0: <ul style="list-style-type: none"> • Signal N of the incremental encoder • DI0 	Use the homing mode "Use zero mark via PROFIdrive telegram".
TM PosInput 1/2 > I/O addresses The organization block ("MC-Servo") and the process image ("TPA OB Servo") are selected automatically for the input and output addresses by selecting the channel in the encoder configuration at the technology object.	–

¹⁾ Parameters are automatically applied when "Automatic data exchange for encoder values (offline)" is selected

"–" No configuration for technology module/technology object is required for these parameters

Additional configuration for use with the technology object measuring input

Configuration	
Technology module	Technology object
TM PosInput 1 / TM PosInput 2	 Measuring input
TM PosInput 1/2 > Channel 0/1 > Operating mode	Hardware interface > Measuring input
Select operating mode "Position detection for Motion Control technology object"	Measuring using PROFIdrive telegram (drive or external encoder)
<p>TM PosInput 1/2 > Channel 0/1 > Module parameters</p> <p>You set the parameters for the encoder signals of the channel under "Module parameters" in the operating mode "Position input for Motion Control". The parameters must be set depending on the encoder used.</p> <p>The configuration of the encoder is required for use with an SSI absolute encoder. Please note the following information in this regard. Information on the configuration is available in the documentation for the respective technology module.</p>	In the "Number of the measuring input" selection box, select "1" (measuring input 1).

Note



When a single-turn absolute encoder is used and two edges are to be measured ("MC_MeasuringInput.Mode" = 2, 3 or 4), the distance between the measured edges of the Measurement input must be < 1 encoder revolution. Otherwise, use a multi-turn absolute encoder.

5.3.3 TM Timer DIDQ 10x24V/TM Timer DIDQ 16x24V (S7-1500, S7-1500T)

You can operate the TM Timer DIDQ technology module centrally on an S7-1500 CPU or decentrally on a distributed I/O. For use with a measuring input, output cam or cam track, the technology module must be used decentrally and with isochronous mode.

For use with Motion Control, the following parameters must be configured:

Use with output cam/cam track technology object

Configuration	
Technology module	Technology object
TM Timer DIDQ 10x24V/TM Timer DIDQ 16x24V	 Output cam /  Cam track
Basic parameters	–
Select desired number of outputs under channel configuration (ET 200MP TM Timer DIDQ 16x24V only)	
Channel parameters	Hardware interface > Output cam output/output cam track
–	Activate output
	Output via Timer DQ
Select "Timer DQ" mode for the respective output	Select output cam output
I/O addresses	–
Select "Isochronous mode"	
The organization block ("MC-Servo") and the process image ("TPA OB Servo") are updated automatically for the input and output addresses by selecting the channel in the encoder configuration at the technology object.	

"–" No configuration for technology module/technology object is required for these parameters

Use with technology object measuring input

Configuration	
Technology module	Technology object
TM Timer DIDQ 10x24V/TM Timer DIDQ 16x24V	 Measuring input
Basic parameters	–
Select desired number of inputs under channel configuration	
Channel parameters	Hardware interface > Measuring input
Configuration of DI group: Use inputs individually	–
Select "Timer DI" mode for the respective input	Select measuring via timer DI
–	Select measuring input
Select application-dependent input delay	–
I/O addresses	
Select "Isochronous mode"	
The organization block ("MC-Servo") and the process image ("TPA OB Servo") are updated automatically for the input and output addresses by selecting the channel in the input configuration at the technology object.	

"–" No configuration for technology module/technology object is required for these parameters

5.3.4 TM Pulse 2x24V (S7-1500, S7-1500T)

For use with Motion Control, the parameters described below must each be configured:

Drive connection using PWM (pulse width modulation)

Configuration	
TM Pulse 2x24V	Technology object
	 Axis
TM Pulse 2x24V > Channel configuration Select if you want to use 1 or 2 channels.	–
TM Pulse 2x24V > Channel > Operating mode Select "Pulse width modulation PWM" or "PWM with DC motor" operating mode	–
TM Pulse 2x24V > Channel > Parameters Select "S7 analog output" output format	Hardware interface > Drive Select analog drive connection For the selection of the analog output, create a PLC tag of the "Int" type with corresponding address. The offset for the PLC tag to the start address is 2. To activate the output of the PWM signal, set the following two bits of the control interface of the PWM channel in the user program: <ul style="list-style-type: none"> • SW_ENABLE (= Bit 0 in Byte 9) • TM_CTRL_DQ (= Bit 1 in Byte 9) The offset for byte 9 to the start address of the PWM channel is 9.
TM Pulse 2x24V > Channel > I/O addresses Select the organization block "MC-Servo" for the input and output addresses. The "TPA OB Servo" process image is selected automatically for the input and output addresses by selecting the organization block.	–

"–" No configuration for technology object is required for these parameters

5.3.5 TM PTO 4 (S7-1500, S7-1500T)

For use with Motion Control, the following parameters must be configured.

Configuration	
Technology module TM PTO 4	Technology object  Axis
TM PTO 4 > Channel configuration	-
Configure the number of channels (1 to 4) you want to use.	
TM PTO 4 > Channel 0...3 > Operating mode	
Select signal type: <ul style="list-style-type: none"> • PTO (pulse (P) and direction (D)) • PTO (count up (A) and count down (B)) • PTO (A, B phase-shifted) • PTO (A, B phase-shifted - quadruple) 	
Select signal interface: <ul style="list-style-type: none"> • RS422, symmetrical/TTL (5V), asymmetrical • 24V asymmetric 	
Configure the interpulse pause for direction reversal.	
-	Hardware interface > Drive Select drive type "PROFIdrive" and "Drive" data connection. Select the pulse output configured at the technology module as drive.
-	Hardware interface > Encoder The encoder of the actuator telegram (simulated encoder) is automatically selected. Alternatively, an existing encoder interface can be selected.
TM PTO 4 > Channel 0...3 > Diagnostic interrupts	-
When the "Enable diagnostic interrupts" check box is selected, diagnostic interrupts are activated if: <ul style="list-style-type: none"> • No supply voltage • Errors occur at digital outputs The detected error is displayed for the respective channel with feedback bit "Fault_Present" and "Sensor_Error".	
TM PTO 4 > Channel 0...3 > Axis parameters	Data exchange with the drive
-	Telegram "DP_TEL3_STANDARD" is automatically selected after the selection of the drive.
-	Clear check box "Automatic data exchange for drive values (online)"
-	Select check box "Automatic data exchange for drive values (offline)" If the check box is cleared, you can manually match the parameters described and identified in this table.
Enter reference speed corresponding to configuration for technology object (1:1)	Enter reference speed of the drive ¹⁾

5.3 Configuring technological modules and onboard I/O for Motion Control (S7-1500, S7-1500T)

Configuration	
Technology module	Technology object
TM PTO 4	 Axis
Enter maximum speed corresponding to configuration for technology object (1:1)	Enter maximum speed of the drive ¹⁾ If the maximum speed is exceeded, technology alarm 102 is triggered and displayed.
–	<p>Data exchange with encoder</p> <p>Telegram "DP_TEL3_STANDARD" is automatically selected after the selection of the encoder.</p> <p>Clear the check box "Automatic data exchange for encoder values (online)"</p> <p>Select the check box "Automatic data exchange for encoder values (offline)" If the check box is cleared, you can manually match the parameters described and identified in this table.</p> <p>Select rotary measuring system type ²⁾</p>
Enter increments per revolution	Enter increments per revolution corresponding to configuration at technology module (1:1) ²⁾
Configure fine resolution <ul style="list-style-type: none"> • 0 = Single • 2 = Quadruple 	Select fine resolution corresponding to configuration on the technology module ²⁾ <ul style="list-style-type: none"> • 0 = Single • 2 = Quadruple
Configure stop behavior <ul style="list-style-type: none"> • Quick stop time • Ramp stop time 	–
TM PTO 4 > Channel 0...3 > Hardware inputs/outputs	–
If you want to use a hardware output to enable the drive, select the "Use drive enable" check box. Next select one of the two hardware outputs DQ0 or DIQ2.	No setting required at the technology object. The output is automatically controlled by the "MC_Power".
	Homing
Activate the hardware input (DI0) for the reference cam.	Use the homing mode "Use zero mark via PROFIdrive telegram".
Select the edge of the hardware input for triggering the reference cam function.	
When using a measuring input, select the "Use DI1 check box as measuring input".	"Measuring input > Configuration > Hardware interface" technology object
	Select the measuring input type "Measuring via PROFIdrive telegram (drive or external encoder)". Select the measuring input "1" under hardware connection.

Configuration	
Technology module	Technology object
TM PTO 4	 Axis
Select the "Use "drive ready"" check box. In the ""Drive ready" input", select the hardware input that is to be used to display whether the drive is ready.	No setting required at the technology object. When the input is used, "MC_Power" waits until the input signal is present before it sets the drive enable.
Configuring input delay	-
TM PTO 4 > Channel 0...3 > Sign-of-life error	
Configure tolerated number of sign-of-life errors	
TM PTO 4 > I/O addresses	
The organization block ("MC-Servo") and the process image ("TPA OB Servo") are selected automatically for the input and output addresses by selecting the PTO channel for the technology object.	

- 1) Parameters are automatically applied when "Automatic data exchange for drive values (offline)" is selected
 - 2) Parameters are automatically applied when "Automatic data exchange for encoder values (offline)" is selected
- "-" No configuration required for these parameters at the technology module/technology object

5.3.6 CPU 1511C-1 PN/CPU 1512C-1 PN (onboard I/O devices) (S7-1500, S7-1500T)

For use with Motion Control, the parameters described below must be configured.

Drive connection via PTO (Pulse Train Output)

Configuration	
CPU 1511C-1 PN/CPU 1512C-1 PN	Technology object
	 Axis
Pulse generators (PTO/PWM) > PTO1...4/PWM1...4 > General To activate a channel for PTO mode, select one of the following operating modes: <ul style="list-style-type: none"> • PTO (pulse (A) and direction (B)) • PTO (count up (A), count down (B)) • PTO (A,B phase shifted) • PTO (A,B phase shifted, quadruple) 	–
–	Hardware interface > Drive Select drive type "PROFIdrive" and "Drive" data connection. Select the pulse generator of the CPU configured for PTO mode as drive. Hardware interface > Encoder The encoder of the actuator telegram (simulated encoder) is automatically selected. Alternatively, an existing encoder interface can be selected.
Pulse generators (PTO/PWM) > PTO1...4/PWM1...4 > Axis parameters	Hardware interface > Data exchange with the drive
–	Telegram "DP_TEL3_STANDARD" is automatically selected after the selection of the drive. Clear check box "Automatic data exchange for drive values (online)"
	Select check box "Automatic data exchange for drive values (offline)" If the check box is cleared, you can manually match the parameters described and identified in this table.
Enter reference speed corresponding to configuration for technology object (1:1)	Enter reference speed of the drive ¹⁾
Enter reference speed corresponding to configuration for technology object (1:1)	Enter maximum speed of the drive ¹⁾ If the maximum speed is exceeded, technology alarm 102 is triggered and displayed.

Configuration	
CPU 1511C-1 PN/CPU 1512C-1 PN	Technology object
	 Axis
-	Hardware interface > Data exchange with encoder Telegram "DP_TEL3_STANDARD" is automatically selected after the selection of the encoder. Clear the check box "Automatic data exchange for encoder values (online)" Select the check box "Automatic data exchange for encoder values (offline)" If the check box is cleared, you can manually match the parameters described and identified in this table. Select rotary measuring system type ²⁾
Enter increments per revolution	Enter increments per revolution corresponding to configuration for CPU (1:1) ²⁾
The fine resolution has the fixed value "0 bit" (= single) and cannot be changed.	Enter the fine resolution corresponding to the configuration on the CPU ²⁾ Bits in incr. actual value (G1_XIST1): 0 (= single)
Pulse generators (PTO/PWM) > PTO1...4/PWM1...4 > Hardware inputs/outputs	Homing
Select the hardware input for the reference switch In addition, configure the input delay for the selected hardware input. You configure the input delay in the device configuration at the corresponding DI channel (DI 16/DQ 16 > Inputs > Channel > Input parameters > Input delay).	Use the homing mode "Use zero mark via PROFIdrive telegram" for drive connection via PTO.
Select the edge of the hardware input for triggering the reference output cam function.	
When using a measuring input, select the hardware input of the measuring input. The following table includes the configuration description.	-
Select the hardware input that is used to display whether the drive is ready. In addition, configure the input delay for the selected hardware input. You configure the input delay in the device configuration at the corresponding DI channel (DI 16/DQ 16 > Inputs > Channel > Input parameters > Input delay).	
With selected "PTO (pulse (A) and direction (B))" mode, the hardware output for the PTO signal A ("Pulse output (A)") is automatically selected through the device configuration and cannot be changed. For PTO signal B ("Direction output (B)") select one of the hardware outputs offered in the selection box. The hardware outputs for the PTO signals are selected through the device configuration for the following operating modes and cannot be changed: <ul style="list-style-type: none"> • PTO (count up (A), count down (B)) • PTO (A,B phase shifted) • PTO (A,B phase shifted, quadruple) 	

5.3 Configuring technological modules and onboard I/O for Motion Control (S7-1500, S7-1500T)

Configuration	
Technology module	Technology object
CPU 1511C-1 PN/CPU 1512C-1 PN	 Axis
Pulse generators (PTO/PWM) > PTO1...4/PWM1...4 > I/O addresses	
The organization block ("MC-Servo") and the process image ("TPA OB Servo") are selected automatically for the input and output addresses by selecting the PTO channel for the technology object.	

- 1) Parameters are automatically applied when "Automatic data exchange for drive values (offline)" is selected
 - 2) Parameters are automatically applied when "Automatic data exchange for encoder values (offline)" is selected
- "-" No configuration for CPU/technology object is required for these parameters

Additional configuration for use with the technology object measuring input

Configuration	
Technology module	Technology object
CPU 1511C-1 PN/CPU 1512C-1 PN	 Measuring input
Pulse generators (PTO/PWM) > PTO1...4/PWM1...4 > Hardware inputs/outputs	Hardware interface > Measuring input
Select the hardware input of the measuring input. In addition, configure the input delay for the selected hardware input. You configure the input delay in the device configuration at the corresponding DI channel (DI 16/DQ 16 > Inputs > Channel > Input parameters > Input delay).	Measuring using PROFIdrive telegram (drive or external encoder) In the "Number of the measuring input" selection box, select "1" (measuring input 1).



Drive connection using PWM (pulse width modulation)



Note that only travel in the positive direction is possible with a drive connection using the integrated PWM function of the compact CPU.

Configuration	
CPU 1511C-1 PN/CPU 1512C-1 PN	Technology object
	 Speed axis
Pulse generators (PTO/PWM) > PTO1...4/PWM1...4 > General	-
Select "Pulse width modulation PWM" mode	
Pulse generators (PTO/PWM) > PTO1...4/PWM1...4 > Hardware inputs/outputs	
Select the hardware output to be used for pulse output.	
Select whether the set hardware output is to work as a fast push-pull switch or as P switch.	
Pulse generators (PTO/PWM) > PTO1...4/PWM1...4 > Parameters	Hardware interface > Drive
Select "S7 analog output" output format	Select analog drive connection For the selection of the analog output, create a PLC tag of the "Int" type with corresponding address. The offset for the PLC tag of the control interface of the PWM channel is 2. To activate the output of the PWM signal, set the following two bits of the control interface of the PWM channel in the user program: <ul style="list-style-type: none"> • SW_ENABLE (= Bit 0 in Byte 9) • TM_CTRL_DQ (= Bit 1 in Byte 9) The offset for byte 9 to the start address of the PWM channel is 9.
Select minimum pulse width of 0 µs	-
Select required period duration (e.g. 100 µs)	
Pulse generators (PTO/PWM) > PTO1...4/PWM1...4 > I/O addresses	
Select the organization block "MC-Servo" for the input and output addresses. The "TPA OB Servo" process image is selected automatically for the input and output addresses by selecting the organization block.	

"-" No configuration for technology object is required for these parameters

Encoder connection via HSC (High-speed counter)

Configuration		
CPU 1511C-1 PN/CPU 1512C-1 PN	Technology object	
	 Axis	 External encoder
High-speed counter (HSC) > HSC 1...6 > General > Enable	–	–
Enable high-speed counter		
High-speed counter (HSC) > HSC 1...6 > Basic parameters > Operating mode		
Select "Position input for Motion Control" mode		
High-speed counter (HSC) > HSC 1...6 > Basic parameters > Module parameters	Hardware interface > Encoder	Hardware interface > Encoder
–	Select "Encoder" data connection and the high-speed counter activated and configured as encoder on the CPU	Select "Encoder" data connection and the high-speed counter activated and configured as encoder on the CPU
Signal type • Incremental encoder	Select encoder type according to the device configuration of the CPU ¹⁾ • Incremental	Select encoder type according to the device configuration of the CPU ¹⁾ • Incremental
–	Hardware interface > Data exchange with encoder	Hardware interface > Data exchange
	Telegram "DP_TEL83_STANDARD" is automatically selected after the selection of the encoder.	Telegram "DP_TEL83_STANDARD" is automatically selected after the selection of the encoder.
	Clear the check box "Automatic data exchange for encoder values (online)"	Clear the check box "Automatic data exchange for encoder values (online)"
	Select the check box "Automatic data exchange for encoder values (offline)" If the check box is cleared, you can manually match the parameters described and identified in this table.	Select the check box "Automatic data exchange for encoder values (offline)" If the check box is cleared, you can manually match the parameters described and identified in this table.
	Select rotary measuring system type ¹⁾	Select rotary measuring system type ¹⁾
Signal evaluation • Single • Double • Quadruple	Enter fine resolution according to the configured signal evaluation set for the high-speed counter (HSC) ¹⁾ • 0 = Single • 1 = Double • 2 = Quadruple	Enter fine resolution according to the configured signal evaluation set for the high-speed counter (HSC) ¹⁾ • 0 = Single • 1 = Double • 2 = Quadruple
Enter increments per revolution	Enter increments per revolution corresponding to device configuration for CPU (1:1) ¹⁾	Enter increments per revolution corresponding to device configuration for CPU (1:1) ¹⁾
–	Hardware interface > Data exchange with the drive	–
Enter reference speed corresponding to configuration for technology object (1:1)	Enter reference speed	

Configuration		
CPU 1511C-1 PN/CPU 1512C-1 PN	Technology object	
	 Axis	 External encoder
-	Homing	Homing
Select the homing signal for homing mark 0: <ul style="list-style-type: none"> Signal N of the incremental encoder DI0 (can be set with the hardware inputs/outputs) In addition, configure the input delay for the selected hardware input. You configure the input delay in the device configuration at the corresponding DI channel (DI 16/DQ 16 > Inputs > Channel > Input parameters > Input delay).	Use the homing mode "Use zero mark via PROFIdrive telegram".	Use the homing mode "Use zero mark via PROFIdrive telegram".
High-speed counter (HSC) > HSC 1...6 > I/O addresses	-	-
The organization block ("MC-Servo") and the process image ("TPA OB Servo") are selected automatically for the input and output addresses by selecting the HSC channel for the technology object.		

1) Parameters are automatically applied when "Automatic data exchange for encoder values (offline)" is selected
 "-" No configuration for CPU/technology object is required for these parameters

Additional configuration for use with the technology object measuring input

Configuration	
Technology module	Technology object
CPU 1511C-1 PN/CPU 1512C-1 PN	 Measuring input
High-speed counter (HSC) > HSC 1...6 > Hardware inputs/outputs	Hardware interface > Measuring input
Select the hardware input of the measuring input. In addition, configure the input delay for the selected hardware input. You configure the input delay in the device configuration at the corresponding DI channel (DI 16/DQ 16 > Inputs > Channel > Input parameters > Input delay).	Measuring using PROFIdrive telegram (drive or external encoder) In the "Number of the measuring input" selection box, select "1" (measuring input 1).



5.3.7 SIMATIC Drive Controller (onboard I/O) (S7-1500T)

You can use the inputs and outputs of interface X142 of a SIMATIC Drive Controller as measuring input for the measuring input technology object, as well as for the output cam/cam track technology object.

Isochronous mode is required for use with a measuring input, output cam or cam track.

For use with Motion Control, the following parameters must be configured:

Use with output cam/cam track technology object

Configuration	
SIMATIC Drive Controller	Technology object
	 Output cam /  Cam track
Channel parameters > Channel 0 to 7	Hardware interface > Output cam output/output cam track
–	Activate output
	Output via Timer DQ
Select desired channel and select operating mode "Timer DQ".	Select output cam output
I/O addresses	–
Select "Isochronous mode"	
The organization block ("MC-Servo") and the process image ("TPA OB Servo") are updated automatically for the input and output addresses by selecting the channel in the encoder configuration at the technology object.	

"–" No configuration at the SIMATIC Drive Controller/technology object is required for these parameters

Use with measuring input technology object

Configuration	
SIMATIC Drive Controller	Technology object
	 Measuring input
Channel parameters > Channel 0 to 7	Hardware interface > Measuring input
–	Select measuring via timer DI
Select desired channel and select operating mode "Timer DI"	Select measuring input
I/O addresses	–
Select "Isochronous mode"	
The organization block ("MC-Servo") and the process image ("TPA OB Servo") are updated automatically for the input and output addresses by selecting the channel in the input configuration at the technology object.	

"–" No configuration at the SIMATIC Drive Controller/technology object is required for these parameters

5.4 Connect drive/encoder via data block (S7-1500, S7-1500T)

Creating the data block for data connection

1. Create a new data block of type "Global DB".
2. Select the data block in the project tree and select "Properties" from the shortcut menu.
3. Disable the following attributes under Attributes and accept the change with "OK":
 - "Only store in load memory"
 - "Data block write-protected in the device"
 - "Optimized block access" for technology version < V4.0
4. Open the data block in the block editor.
5. Insert a tag structure of type "PD_TELx" textually in the block editor.

This tag structure contains the "Input" tag structure for the input area of the telegram and the "Output" tag structure for the output area of the telegram.

Note

"Input" and "Output" relate to the view of the closed loop position control. For example, the input area contains the actual values of the drive and the output area contains the setpoints for the drive.

The data block may contain the data structures of multiple axes and encoders and other contents.

Configuring data connection via a data block

1. Open the configuration window "Hardware interface > Drive" or "Hardware interface > Encoder".
2. Select the entry "Data block" from the "Data block" drop-down list.
3. In the "Data block" field, select the previously created data block.
Open this data block and select the tag name defined for the drive and encoder.

Programming MC-PreServo and MC-PostServo

1. Assign the previously defined PLC tag of the input range of the data block to MC-PreServo .
2. Assign the previously defined PLC tag of the output range of the data block to MC-PostServo.

NOTICE
Machine damage Improper manipulation of drive and encoder telegrams may result in unwanted drive motions. Check your user program for consistency in the drive and encoder connection.

An application example for the use of MC-PreServo and MC-PostServo is available at:

<https://support.industry.siemens.com/cs/document/109741575>

(<https://support.industry.siemens.com/cs/ww/en/view/109741575>)

5.5 Parameter view (S7-1500, S7-1500T)

The Parameter view provides you with a general overview of all relevant parameters of a technology object. You obtain an overview of the parameter settings and can easily change them in offline and online mode.

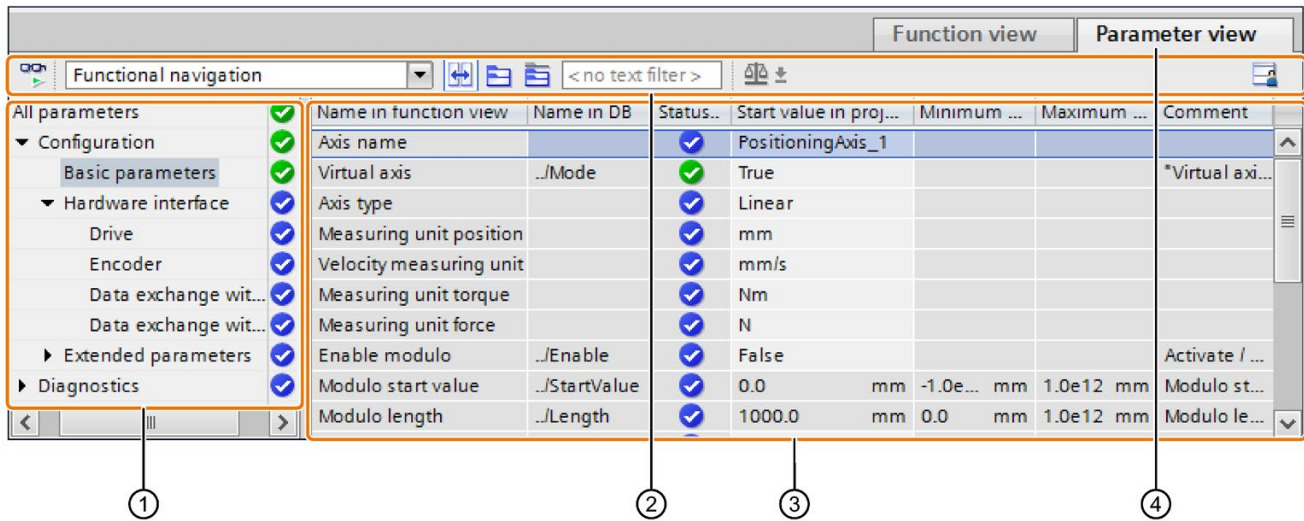

- ① Navigation (Page 89)
- ② Toolbar (Page 88)
- ③ Parameter table (Page 89)
- ④ "Parameter view" tab

Function scope

The following functions are available for analyzing the parameters of the technology objects and for enabling targeted monitoring and modification.

Display functions:

- Display of parameter values in offline and online mode
- Display of status information of the parameters
- Display of value deviations and option for direct correction
- Display of configuration errors
- Display of value changes as a result of parameter dependencies
- Display of all memory values of a parameter: Start value PLC, Start value in project, Monitor value
- Display of the parameter comparison of the memory values of a parameter







Operator control functions:

- Navigation for quickly changing between the parameters and parameter structures.
- Text filter for faster searches for particular parameters.
- Sorting function for customizing the order of parameters and parameter groups to requirements.
- Memory function for backing up structural settings of the Parameter view.
- Monitoring and modifying of parameter values online.
- Function for saving a snapshot of parameter values of the CPU in order to capture momentary situations and to respond to them.
- Function for applying a snapshot of parameter values as start values.
- Download of modified start values to the CPU.
- Comparison functions for comparing parameter values with one another.

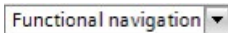
5.5.1 Structure of the parameter view (S7-1500, S7-1500T)

5.5.1.1 Toolbar (S7-1500, S7-1500T)

The following functions can be selected in the toolbar of the parameter view.

Symbol	Function	Explanation
	Monitor all	Starts monitoring of the visible tags in the active table.
	Select navigation structure	Toggle between function-based navigation and the view of the data structure of the technology data block.
	Couples the function view and parameter view for the objects selected in the navigation	Enables the targeted toggling between the parameter view and function-based view.
	Collapse/expand all nodes and objects	Collapses or expands all nodes and objects of the navigation or the data structure in the currently active view.
	Collapse/expand the nodes below the marked nodes	Collapses or expands the marked nodes and objects of the navigation or the data structure in the currently active view.
	Text filter...	After entry of a character string: Display of all parameters containing the entered string in one of the currently visible columns.
	Selection of compare values	Selection of parameter values that are to be compared with one another in online mode (Start value in project, Start value PLC) Only in online mode.
	Save window settings	Saves your display settings for the Parameter view (e.g. selected navigation structure, activated table columns, etc.)

5.5.1.2 Navigation (S7-1500, S7-1500T)

Within the "Parameter view" tab, the following alternative navigation structures can be selected.

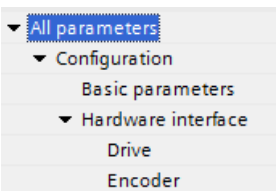
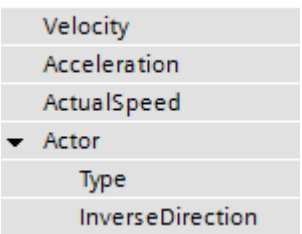
Navigation		Explanation
Functional navigation		In the functional navigation, the structure of the parameters is based on the structure in the configuration window ("Function view" tab), commissioning window and diagnostics window.
Data structure		In the "Data structure" navigation, the structure of the parameters is based on the structure of the technology data block.

You can use the "Select navigation structure" drop-down list to toggle the navigation structure.

5.5.1.3 Parameter table (S7-1500, S7-1500T)

The table below shows the meaning of the individual columns of the parameter table. You can show or hide the columns as required.

Column	Explanation	Offline	Online
Name in function view	Name of the parameter in the function view. The display field is empty for parameters that are not configured via the technology object.	X	X
Name in DB	Name of the parameter in the technology data block. If the parameter is part of a structure or UDT, the prefix "../" is added. The display field is empty for parameters that are not contained in the technology data block.	X	X
Full name in DB	Complete path of the parameter in the instance data block. The display field is empty for parameters that are not contained in the technology data block.	X	X
Status of configuration	Display of the completeness of the configuration using status symbols.	X	-
Compare result	Result of the "Compare values" function. This column is displayed when there is an online connection.	-	X
Start value in project	Configured start value in project. Error indication if entered values have a syntax or process-related error.	X	X

Column	Explanation	Offline	Online
Default value	Value that is pre-assigned to the parameter. The display field is empty for parameters that are not contained in the technology data block.	X	X
Start value PLC	Start value in the CPU. This column is displayed when there is an online connection.	-	X
Monitor value	Current value in the CPU. This column is displayed when there is an online connection.	-	X
Modify value	Value that is to be used to change the monitor value. This column is displayed when there is an online connection.	-	X
Minimum value	Minimum process-related value of the parameter. If the minimum value is dependent on other parameters, it is defined: <ul style="list-style-type: none"> Offline: by the start value in the project. Online: by the monitor values. 	X	X
Maximum value	Maximum process-related value of the parameter. If the maximum value is dependent on other parameters, it is defined: <ul style="list-style-type: none"> Offline: by the start value in the project. Online: by the monitor values. 	X	X
Setpoint	Designates the parameter as a setpoint. These parameters can be initialized online.	X	X
Data type	Data type of the parameter. The display field is empty for parameters that are not contained in the technology data block.	X	X
Retain	Designates the value as a retentive value. The values of retentive parameters are retained even after the voltage supply is switched off.	X	X
Accessible from HMI	Indicates whether the HMI can access this parameter during runtime.	X	X
Visible in HMI	Indicates whether the parameter is visible in the selection list of the HMI by default.	X	X
Comment	Brief description of the parameter.	X	X

X This function is visible in offline/online mode.

- This function is not visible in offline/online mode.

5.5.2 Opening the parameter view (S7-1500, S7-1500T)

Requirement

The technology object was added in the project navigator.

Procedure

1. Open the "Technology objects" folder in the project tree.
2. Open the technology object in the project tree.
3. Double-click the "Configuration" object.
4. Select the "Parameter view" tab in the top right corner.

Result

The Parameter view opens. Each displayed parameter is represented by one row in the parameter table.

The displayable parameter properties (table columns) vary depending on whether you are working with the Parameter view in offline or online mode.

In addition, you can selectively display and hide individual table columns.

5.5.3 Working with the parameter view (S7-1500, S7-1500T)

The following table provides an overview of the functions of the Parameter view in online and offline mode described below:

Function/action	Offline	Online
Filtering the parameter table (Page 92)	X	X
Sorting the parameter table (Page 92)	X	X
Transferring parameter data to other editors (Page 93)	X	X
Indicating errors (Page 93)	X	X
Editing start values in the project (Page 94)	X	X
Monitoring values online in the parameter view (Page 95)	-	X
Modifying values (Page 96)	-	X
Comparing values (Page 97)	-	X

X This function is possible in offline/online mode.

- This function is not possible in offline/online mode.

5.5.3.1 Filtering the parameter table (S7-1500, S7-1500T)

You can filter the parameters in the parameter table in the following ways:

- With the text filter
- With the subgroups of the navigation

Both filter methods can be used simultaneously.

With the text filter

The text filter can only be used on texts in displayed parameter lines and displayed columns.

To work with the text filter, follow these steps:

1. To filter a desired character string, enter it in the "Text filter..." input box.

The parameter table displays only the parameters containing the character string.

To reset text filtering, the following options are available:

- Select another parameter group in the navigation.
- Switch between data navigation and functional navigation, or vice versa.

With the subgroups of the navigation

To filter the navigation with the subgroups, follow these steps:

1. Click the desired parameter group in the navigation, e.g., "Static".

The parameter table now only shows the "static" parameters. You can select further subgroups for some groups of the navigation.

2. If all parameters are to be shown again, click "All parameters" in the navigation.

5.5.3.2 Sorting the parameter table (S7-1500, S7-1500T)

The values of the parameters are arranged in rows. The parameter table can be sorted by any displayed column.

- In columns containing numerical values, sorting is based on the magnitude of the numerical value.
- In text columns, sorting is alphabetical.

Sort column-by-column

1. Position the cursor in the header cell of the desired column.

The background of this cell turns blue.

2. Click the column header.

Result

The entire parameter table is sorted by the selected column. A triangle with tip facing up appears in the column header.

Clicking the column header again changes the sorting as follows:

Symbol	Description
▲	Parameter table is sorted in ascending order.
▼	Parameter table is sorted in descending order.
No symbol	The sorting is removed again. The parameter table shows the default display.

The "../" prefix in the "Name in DB" column is ignored when sorting.

5.5.3.3 Transferring parameter data to other editors (S7-1500, S7-1500T)

You can paste parameters of the parameter view in the following editors:

- Program editor
- Watch table
- Signal table for Trace

The following options are available for pasting:

- Drag-and-drop
- <Ctrl+C>/<Ctrl+V>
- Copy/Paste via shortcut menu

5.5.3.4 Indicating errors (S7-1500, S7-1500T)

Error display

Parameter assignment errors that result in compilation errors (e.g. limit violation) are indicated in the Parameter view.

Every time a value is entered in the Parameter view, a check is made for process-related and syntax errors and displayed with the following indicators:

- Red error symbol in the "Status of configuration" (offline mode) or "Compare result" (online mode, depending on the selected comparison type) columns
- Table field with red background

If you click the bad field, a roll-out error message appears with information of the permissible value range or the required syntax (format)

Compilation error

From the error message of the compiler, you can directly open the Parameter view (functional navigation) containing the parameter causing the error in situations where the parameter is not displayed in the configuration window.

5.5.3.5 Editing start values in the project (S7-1500, S7-1500T)

With the Parameter view, you can edit the start values in the project in offline mode and online mode.

- You make value changes in the "Start value in project" column of the parameter table.
- In the "Status of configuration" column of the parameter table, the progress of the configuration is indicated by the familiar status symbols from the configuration window of the technology object.

Boundary conditions

- If other parameters depend on the parameter whose start value was changed, the start value of the dependent parameters are also adapted.
- If a parameter of a technology object is not editable, it is also not editable in the parameter view. The ability to edit a parameter can also depend on the values of other parameters.

Defining new start values

To define start values for parameters in the Parameter view, follow these steps:

1. Open the Parameter view of the technology object.
2. Enter the desired start values in the "Start value in project" column. The value must match the data type of the parameter and must not exceed the value range of the parameter.
The limits of the value range can be seen in the "Maximum value" and "Minimum value" columns.

The "Status of configuration" column indicates the progress of the configuration with colored symbols.

Following adaptation of the start values and downloading of the technology object to the CPU, the parameters take the defined value at startup if they are not declared as retentive ("Retain" column).

Error display

When a start value is input, a check is made for process-related and syntax errors and the result is indicated.

Bad start values are indicated by:

- Red error symbol in the "Status of configuration" (offline mode) or "Compare result" (online mode, depending on the selected comparison type) columns

and/or

- Red background in the "Start value in project" field
If you click on the bad field, a roll-out error message appears with information of the permissible value range or the necessary syntax (format)

Correcting bad start values

1. Correct bad start values using information from the roll-out error message.
Red error symbol, red field background, and roll-out error message are no longer displayed.
The project cannot be successfully compiled unless the start values are error-free.

5.5.3.6 Monitoring values online in the parameter view (S7-1500, S7-1500T)

You can monitor the values currently taken by the parameters of the technology object in the CPU (monitor values) directly in the Parameter view.

Requirements

- There is an online connection.
- The technology object is downloaded to the CPU.
- The Parameter view of the technology object is open.

Procedure



As soon as the Parameter view is online, the following columns are additionally displayed:

- Compare result
- Start value PLC
- Monitor value
- Modify value
- Selection for transmission

The "Monitor value" column shows the current parameter values on the CPU.

Display

All columns that are only available online are displayed in color as follows:

Color	Description
	The values are modifiable.
	These values cannot be changed.

See also

Parameter table (Page 89)

5.5.3.7 Modifying values (S7-1500, S7-1500T)

With the Parameter view, you can modify values of the technology object in the CPU. You can assign values to a parameter once (Modify value) and modify them immediately. The modify request is executed as quickly as possible without reference to any particular point in the user program.

! DANGER

Danger when modifying

Changing the parameter values while the plant is operating may result in severe damage to property and personal injury in the event of malfunctions or program errors.

Make sure that dangerous states cannot occur before you use the "Modify" function.

Requirements

- There is an online connection.
- The technology object is downloaded to the CPU.
- The Parameter view of the technology object is open.
- The parameter is modifiable. (Associated field in the "Modify value" column has a corresponding background).

Procedure

To modify values immediately, follow these steps:

1. Enter the desired modify value in the "Modify values" column of the parameter table.
The parameter is modified once and immediately with the specified value. You can monitor the value in the "Monitor values" column. The check box for modifying in the "Selection for transmission" column is automatically cleared after the modify request is complete.

Error display

When a modify value is input, a check is made immediately for process-related and syntax errors and the result is indicated.

You can recognize incorrect modify values as follows:

- The field "Modify value" is displayed with red background color.
- If you click in the incorrect field, a roll-out error message appears with information on the permissible value range or the necessary syntax.

Bad modify values

- Modify values with process-related errors can be transmitted.
- Modify values with syntax errors cannot be transmitted.

5.5.3.8 Comparing values (S7-1500, S7-1500T)

You can use comparison functions to compare the following memory values of a parameter:

- Start value in project
- Start value PLC

Requirements

- There is an online connection.
- The technology object is downloaded to the CPU.
- The Parameter view of the technology object is open.

Procedure

To compare the start values on the various target systems, follow these steps:

1. Click the "Selection of compare values" icon .

A selection list containing the comparison options opens:





- Start value in project - Start value in CPU (default setting)

2. Select the desired comparison option.

The selected comparison option is executed as follows:

- A scales symbol appears in the header cells of the two columns selected for comparison.
- Symbols are used in the "Compare result" column to indicate the result of the comparison of the selected columns.

Symbol in "Compare result" column

Symbol	Meaning
	The compare values are equal and error-free.
	The compare values are not equal and error-free.
	At least one of the two compare values has a process-related or syntax error.
	The comparison cannot be performed. At least one of the two comparison values is not available (e.g. snapshot).

Symbol in the navigation

The symbols are shown in the same way in the navigation if the compare result applies to at least one of the parameters below the displayed navigation structure.

Programming (S7-1500, S7-1500T)

The "Programming" section contains general information on supplying and evaluating the Motion Control instructions and on the technology data block.

You can use Motion Control instructions in the user program to assign jobs to the technology object. You define the job using the input parameters of the Motion Control instructions. You can track the current job status using the job parameters if you use a separate instance for each Motion Control instruction per technology object.

In a typical programming, you can use one or more instances for each Motion Control instruction for each technology object.

The use of a separate instance per technology object is always necessary for Motion Control instructions without parameter "DONE" and for the Motion Control instruction "MC_MoveJog".

Only one instance per technology object may be active in the program flow for the Motion Control instruction "MC_Power". Disable the technology object with the same instance you used to enable the technology object, otherwise an error with error ID 16#800C will occur.

The technology data block is available to you as an additional interface to the technology object.

6.1 Technology data block (S7-1500, S7-1500T)

The properties of real objects (e.g. axes) are configured by means of the technology objects and saved in a technology data block. The technology data block contains all configuration data, setpoint and actual values, and status information of the technology object. The TIA Portal automatically creates the technology data block when the technology object is created. You access the data of the technology data block (read/write access) with your user program.

A listing and description of the tags can be found in the Appendix (Page 140).

6.1.1 Evaluating the technology data block (S7-1500, S7-1500T)

Access to data in the technology data block occurs in accordance with the access to standard data blocks. Only tags with elementary data types can be accessed in the technology data block. Access to a complete data structure (e.g. STRUCT, ARRAY) is not possible.

Reading values from the technology data block

In your user program you can read actual values (e.g. current position) and status information, or detect error messages in the technology object. When you program a query in your user program (e.g. current velocity), the value is directly read from the technology object.

Reading values from the technology data block takes longer than for other data blocks. If you use these tags several times in a single cycle of your user program, it is recommended to copy the tag values to local tags, and use the local tags in your program.

Writing values to the technology data block

The configuration of the technology object in the TIA Portal is used to write the corresponding data to the technology data block. After they have been loaded into the CPU, these data are stored in the CPU on the SIMATIC Memory Card (load memory).

In the following cases, it may be necessary for the user program to write values to the technology data block:

- Adaptation of the configuration of the technology object (e.g. dynamic limits, software limit switches)
- Use of overrides
- Adaptation of position control (e.g. "Kv" parameter)

Changes to values in the technology data block by the user program can take effect at various points in time. The relevant property of the individual tags can be found in their descriptions in the Appendix (Page 140):

Effectiveness of changes	Description	
Direct (DIR)	You write changes using direct assignments. The changes are applied only at the start of the next MC-Servo [OB91]. The changes are retained until the next POWER OFF of the CPU or restart of the technology object.	
	LREAL (e.g. <TO>.Override.Velocity)	The technology object performs a range check on the written value, and immediately starts using the new value. If range limits are violated when writing, the technology object automatically corrects the values. If the value is below the range, then the value is set to the low limit of the range; if the range is exceeded, then the value is set to the high limit of the range.
	DINT/BOOL (e.g. <TO>.PositionLimits_SW.Active)	Changes are only permitted in the defined value range. Value changes outside the value range are not applied. If you enter invalid values, the programming error OB (OB 121) is started.
When Motion Control instruction is called (CAL) (e.g. <TO>.Sensor[1..4].ActiveHoming.HomePositionOffset)	You write changes using direct assignments. The changes are applied at the start of the next MC-Servo [OB91] after the call of the corresponding Motion Control instruction in the user program. The changes are retained until the next POWER OFF of the CPU or restart of the technology object.	
Restart (RES) (e.g. <TO>.Homing.AutoReversal)	Since restart-relevant tags have dependencies on other tags, value changes cannot be applied at any arbitrary time. The changes are only used after reinitialization (restart) of the technology object. During a restart the technology object is reinitialized with the data in load memory. You therefore write changes to the start value in the load memory with the extended instruction "WRIT_DBL" (write to data block in load memory). You trigger the restart in your user program using the Motion Control instruction "MC_Reset" with parameter "Restart" = TRUE. Additional information regarding the restart can be found in the section Restarting technology objects (Page 127).	
Read only (RON) (e.g. <TO>.Position)	The tag cannot and must not be changed during runtime of the user program.	

Note**Save changes with "WRIT_DBL"**

Changes to tags immediately in effect are lost on POWER OFF of the CPU, or restart of the technology object.

If changes in the technology data block should also be retained after POWER OFF of the CPU, or restart of the technology object, you must write the changes to the start value in the load memory with the extended instruction "WRIT_DBL".

Note**Using the "READ_DBL" and "WRIT_DBL" data block functions**

The "READ_DBL" and "WRIT_DBL" data block functions may only be used on individual tags in conjunction with the tags of the technology object. The "READ_DBL" and "WRIT_DBL" data block functions must not be applied to data structures of the technology object.

Isochronous evaluation of data

If you want to process data of the technology data block in isochronous mode from a Motion Control application cycle, there is the option of evaluating this data in the MC-PreServo [OB67]/MC-PostServo [OB95] as of technology version V3.0. As of technology version V5.0, you also have the option of evaluating these in MC-PreInterpolator [OB68].

See also

Organization blocks for Motion Control (Page 23)

6.1.2 Evaluate StatusWord, ErrorWord and WarningWord (S7-1500, S7-1500T)

To be able to symbolically use individual status and error information from the "StatusWord", "ErrorWord" and "WarningWord" data double words, you can evaluate them as described below. For consistent evaluation, you should avoid using bit addressing to access these data double words in the technology data block. Access to an individual bit in the technology data block only lasts as long as the access to the entire data word.

When required, copy the required data double word to a tag of a data structure and query the individual bits of the tag.

The allocation of the individual bits in the data double words can be found in the Appendix (Page 140) in the description of the tags of the corresponding technology object.

Requirements

The technology object has been created.

Procedure

To evaluate the individual bits in the data word "StatusWord", follow these steps:

1. Create a global data structure. Name the data structure, e.g. as "Status".
2. Create a double word (DWORD) in the data structure "Status". Name the double word, e.g. as "Temp".
3. Create 32 Boolean tags in the "Status" data structure. You can obtain a clearer overview by giving the individual Boolean tags identical names as the bits in the technology DB (e.g. name the fifth Boolean tag "HomingDone").
4. If needed, copy the tag "<TO>.StatusWord" from the technology data block to the double word "Temp" in your data structure.
5. Copy the individual bits of double word "Temp" to the corresponding Boolean tags with bit accesses.
6. Use the Boolean tags to query the status bits.

Evaluate the data words "ErrorWord" and "WarningWord" as specified in steps 1 to 6.

Example

The following example shows how you can read out and save the fifth bit "HomingDone" of the data word "StatusWord":

SCL	Explanation
#Status.Temp := "TO".StatusWord;	//Copy status word
#Status.HomingDone := #Status.Temp.%X5;	//Copy individual bits per bit access

STL	Explanation
L "TO".StatusWord	//Copy status word
T #Status.Temp	
U #Status.Temp.%X5	//Copy individual bits per bit access
= #Status.HomingDone	

6.1.3 Change restart-relevant data (S7-1500, S7-1500T)

In order to change restart-relevant data in the technology data block, write to the starting values of the tags in load memory using the extended instruction "WRIT_DBL". In order for the changes to be applied, a restart of the technology object must be performed.

You can see from the description of the tag of the corresponding technology object whether value changes of a tag are restart-relevant.

Requirement

The technology object has been created.

Procedure

To change restart-relevant data, proceed as follows:

1. Create a data block and fill it with the restart-relevant values, that you want to change in the technology data block. In doing so, the data types must match the tags to be changed.
2. Write the values from your data block to the starting values of the tags of the technology data block in load memory, using the extended instruction "WRIT_DBL".

If restart-relevant data were changed, this will be indicated in the "<TO>.StatusWord.X3 (OnlineStartValuesChanged)" tag of the technology object.

3. Perform a restart of the technology object using the Motion Control instruction "MC_Reset" with parameter "Restart" = TRUE.

After the restart of the technology object, the new value is transferred into the technology data block in work memory, and is effective.

6.2 Motion Control instructions (S7-1500, S7-1500T)

6.2.1 Motion Control instruction parameters (S7-1500, S7-1500T)

The individual Motion Control instructions are described in detail in the section "S7-1500 Motion Control V5".

When creating your user program, take the following explanations of the Motion Control instruction parameters into account.

Reference to the technology object

The technology object is specified for the Motion Control instruction as follows:

- **Parameter "Axis"**

The "Axis" input parameter of a Motion Control instruction contains a reference to the technology object that is to execute the corresponding job.

The corresponding technology object is also referenced in the following parameters:

- Parameter "Master"
- Parameter "Slave"
- Parameter "Cam"
- Parameter "MeasuringInput"
- Parameter "OutputCam"
- Parameter "CamTrack"

As of technology version V3.0, the reference to the technology object can be specified, also in limited manner, via the data type "DB_ANY". For more information, refer to the section "Parameter transfer for function blocks (Page 110)".

Job start and transfer of input parameters of a Motion Control instruction

For the start of jobs and the transfer of modified parameter values, a distinction is made between the following Motion Control instructions:

- **Motion Control instructions with "Execute" parameter**

With a positive edge at the "Execute" parameter, the job is started and the existing values for the input parameters are transferred.

Subsequently changed parameter values are not transferred until the next job start.

Resetting the "Execute" parameter does not end the job, but it does affect the display duration of the job status. As long as "Execute" is set to "TRUE", the output parameters will be updated. If "Execute" is reset before the completion of a job, the parameters "Done", "Error" and "CommandAborted" are correspondingly set for only one call cycle.

- **Motion Control instructions with "Enable" parameter**

The job is started by setting the "Enable" parameter.

As long as "Enable" = TRUE, the job remains active and changed parameter values will be transferred each time the instruction is called in the user program.

The job is ended by resetting the "Enable" parameter.

The input parameters "JogForward" and "JogBackward" of the Motion Control instruction "MC_MoveJog" correspond in their behavior to the "Enable" parameter.

Job status

The following output parameters indicate the status of the job execution:

- **Motion Control instructions with "Done" parameter**

The normal completion of a job is indicated with parameter "Done" = TRUE.

- **Motion Control instructions without "Done" parameter**

The achievement of the job objective is indicated by other parameters (e.g. "Status", "InVelocity"). For more information, refer to the "Tracking running jobs (Page 114)" section.

- **Parameter "Busy"**

As long as a job is in progress, the "Busy" parameter shows the value "TRUE". If a job was ended or canceled, "Busy" shows the value "FALSE".

- **Parameter "Active"**

If a job is active in Motion Control, the parameter "Active" shows the value "TRUE". As long as a job is in the job sequence, "Active" shows the value "FALSE".

- **Parameter "CommandAborted"**

If a job was canceled by another job, the "CommandAborted" parameter shows the value "TRUE".

- **Parameter "Error"**

If a Motion Control instruction error occurs, the "Error" parameter shows the value "TRUE". The "ErrorID" parameter indicates the cause of the error.

As long as the "Execute" or "Enable" parameter is set to "TRUE", the output parameters will be updated. Otherwise, the parameters "Done", "Error" and "CommandAborted" are correspondingly set for only one cycle.

Abort of running jobs

An active Motion Control job is aborted by the start of a new Motion Control job. In the process, the current dynamic setpoints (acceleration, deceleration, jerk, velocity) are set to the values of the overriding job.

Example of parameter behavior

The behavior of the parameters of Motion Control instructions is shown in the following chart using the example of two "MC_MoveAbsolute" jobs.

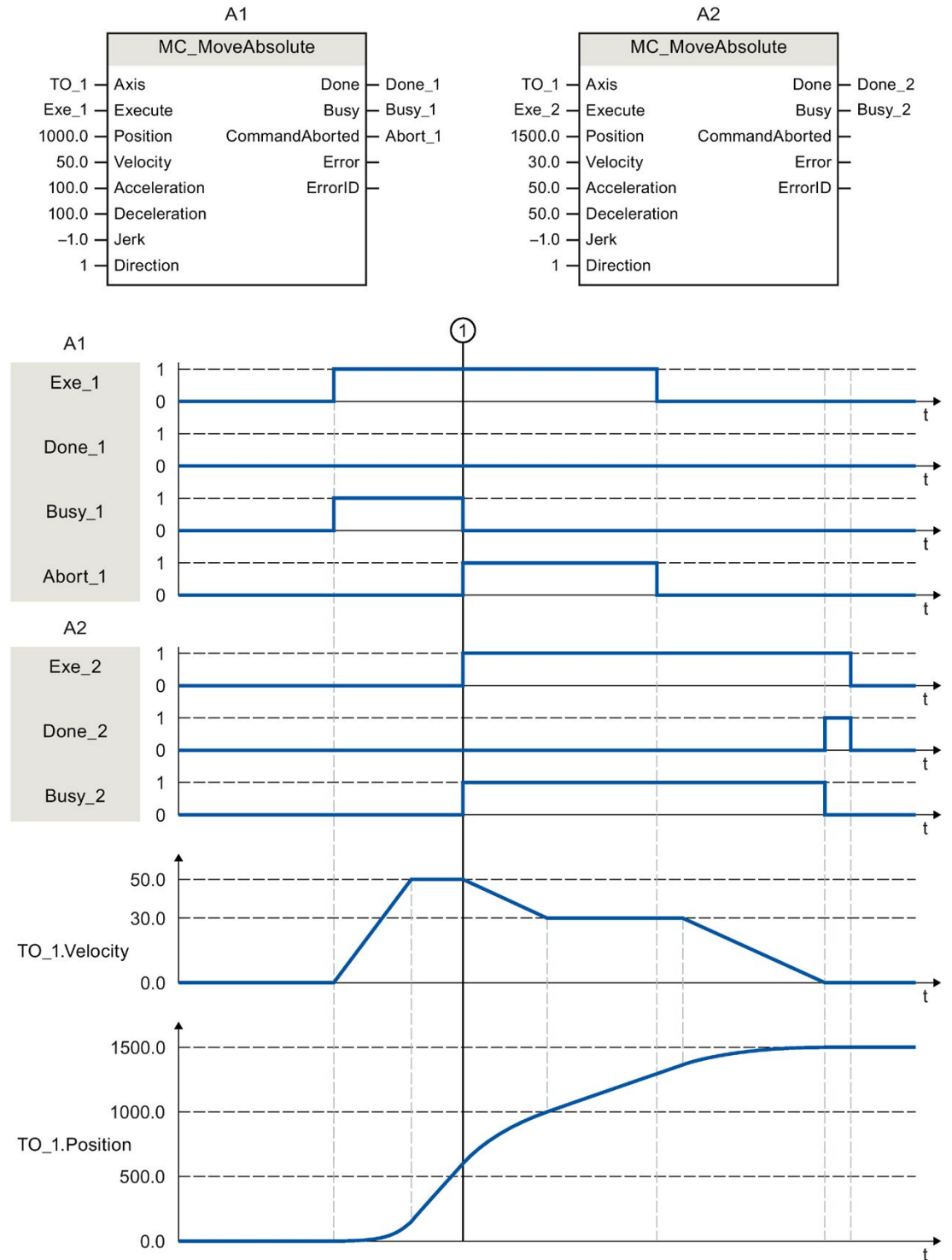

Using "Exe_1", an "MC_MoveAbsolute" job (A1) with target position 1000.0 is initiated. "Busy_1" is set to "TRUE". The axis is accelerated to the specified velocity and moved to the target position (see TO_1.Velocity and TO_1.Position). Before the target position is reached, the job is overridden at time ① by another "MC_MoveAbsolute" job (A2). The termination is signaled via "Abort_1", and "Busy_1" is set to "FALSE". The axis is braked to the velocity specified in A2 and moved to the new target position 1500.0. When the axis reaches the target position, this is signaled via "Done_2".

Non position-controlled operation

The position control of the axis can be deactivated with the following parameters:

- MC_Power.StartMode = 0
- MC_MoveVelocity.PositionControlled = FALSE
- MC_MoveJog.PositionControlled = FALSE

For more information, refer to the section "Non position-controlled operation" of the "S7-1500/S7-1500T Axis functions"

(<https://support.industry.siemens.com/cs/ww/en/view/109766462>) documentation.

6.2.2 Add Motion Control instructions (S7-1500, S7-1500T)

You add Motion Control instructions to a program block in the same way as other instructions. You control all available functions of the technology object using the Motion Control instructions. The instructions can be called at all execution levels.

Requirements

The technology object was created.

Procedure

To add Motion Control instructions in your user program, proceed as follows:

1. Double click your program block in the project tree (the program block must be called in the cyclical program).

The program block is opened in the programming editor, and the available instructions are displayed.

2. In the "Instructions" task card, open the "Technology > Motion Control" folder.
3. Using drag-and-drop, move the Motion Control instruction, e.g. "MC_Power", to the desired segment of the program block.

The "Call options" dialog opens.

4. In the dialog, specify a name and a number for the instance data block of the Motion Control instruction.

- Click "OK".

The Motion Control instruction "MC_Power" is inserted into the network.

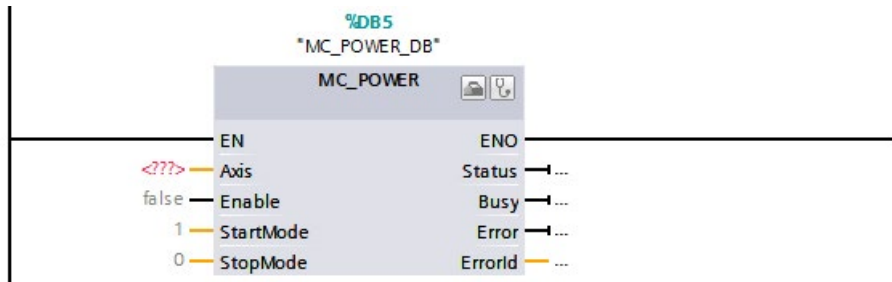

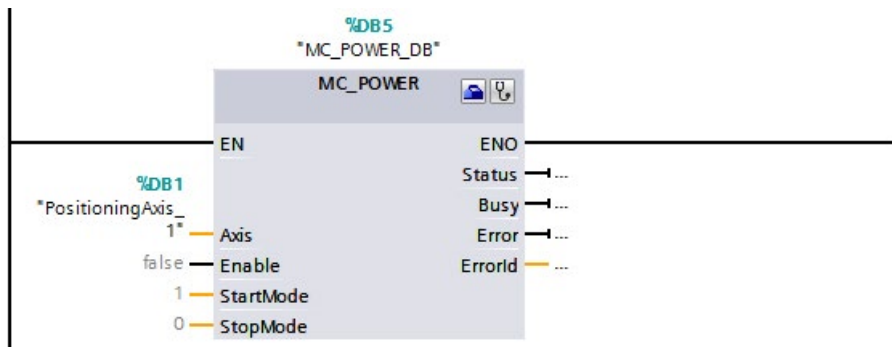

The instance data block is automatically created under "Program Blocks > System Blocks > Program Resources".

- Input parameters without a default value (e.g. "Axis"), must be assigned. Select the technology object in the project tree and move the technology object onto <...> at the "Axis" parameter using drag-and-drop.



Once the technology object is specified in the "Axis" parameter, the following buttons are available to you:

	To open the configuration of the technology object, click on the toolbox icon.
	To open the diagnostics of the technology object, click on the stethoscope icon.

- Add additional Motion Control instructions in accordance with steps 3 through 6.

See also

Tracking active jobs (Page 114)

6.2.3 Parameter transfer for function blocks (S7-1500, S7-1500T)

If you want to reuse a function block with Motion Control instructions for different technology objects, create an input parameter of the data type of the respective technology object in the block interface of the calling function block. You assign the data type in the block interface with a direct input. The parameter is then transferred as reference to the technology object to the "Axis" parameter of the Motion Control instructions. The data types of technology objects correspond to the structure of the associated technology data block.

In contrast to standard data types, the data types for technology objects are always passed on as pointers to the function block (Call by reference). This remains true if you declare the data types of the technology objects in "Input" area of the block interface. Write access to function blocks always leads directly to modification of the referenced technology object.

Example 1: Tag transfer with specific data type

By specifying the data type, you can address the tags of the technology object in the function block (<parameters of the block interface>.<tag of the technology object>). The data types for the reference to the technology objects are available in the section "appendix (Page 178)".

The following table shows the declaration of the tags used:

Tag	Declaration	Data type	Description
axis	Input	TO_PositioningAxis	Reference to the technology object
on	Input	BOOL	Signal to enable the axis
actPosition	Output	LReal	Query of the actual position from the technology data block
instMC_POWER	Static	MC_POWER	Multinstance of the Motion Control instruction "MC_Power"

The following SCL program shows the tag transfer with a specific data type:

SCL	Explanation
#instMC_POWER(Axis := #axis, Enable := #on);	//Call of the Motion Control instruction "MC_Power" with enable of the axis
#actPosition := #axis.ActualPosition;	//Query of the actual position from the technology data block

Example 2: Tag transfer with "DB_Any"

The data type "DB_Any" provides a further option for the transfer of specific data types of the technology object. Unlike the data types of the technology object in the program, "DB_Any" can be assigned during runtime.

This example shows how you can program variable switching of up to four cams at "MC_CamIn".

To do this, tags of the data type "DB_Any" are first created as input parameter of the block. The cam to be used is assigned by an additional input parameter.

The following table shows the declaration of the tags used:

Tag	Declaration	Data type	Description
cam1	Input	DB_ANY	Cam 1
cam2	Input	DB_ANY	Cam 2
cam3	Input	DB_ANY	Cam 3
cam4	Input	DB_ANY	Cam 4
camToUse	Input	Int	Selection of cam 1 to 4
instMC_CAMIN	Static	MC_CAMIN	Multinstance of the Motion Control instruction "MC_CamIn"
tempCamSel	Temp	DB_ANY	Current cam

The following SCL program shows the tag transfer with "DB_Any":

SCL	Explanation
	//Selection of the desired cam 1..4
	//Using an input tag of data type Int
CASE #camToUse OF	
1: #tempCamSel := #cam1;	//Instruction for scenario 1
2: #tempCamSel := #cam2;	//Instruction for scenario 2
3: #tempCamSel := #cam3;	//Instruction for scenario 3
4: #tempCamSel := #cam4;	//Instruction for scenario 4
ELSE	//Instruction for Int ≤ 0 or Int > 4
#tempCamSel := #cam1;	//Corresponds to default cam 1
END_CASE;	
	//Call of the Motion Control instruction "MC_CamIn" with variable transfer of the cam technology object using the temporary tag "tempCamSel"
#instMC_CAMIN(Master := "PositioningAxis_1",	//Direct assignment of the technology object of the leading axis
Slave := "SynchronousAxis_1",	//Direct assignment of the technology object of the following axis
Cam := #tempCamSel);	//Indirect assignment of the cam technology object

Additional information

You can find more program examples for the use of the data type "DB_Any" in the following FAQ entry:

<https://support.industry.siemens.com/cs/ww/en/view/109750880>
<https://support.industry.siemens.com/cs/ww/en/view/109750880>

6.3 Starting Motion Control jobs (S7-1500, S7-1500T)

Motion Control jobs are started by setting the "Execute" or "Enable" parameter of the Motion Control instruction. The call of the Motion Control instructions for a technology object should occur in an execution level.

When executing Motion Control jobs, you should also take note of the status of the technology object.

Starting Motion Control jobs should be performed in the following steps:

1. Query the status of the technology object.
2. Initiate new job for the technology object.
3. Check job status.

These steps are explained using the example of a job for absolute positioning.

1. Query the status of the technology object

Make sure that the technology object is in the appropriate status to perform the desired job:

- **Has the technology object been released?**

To execute motion jobs, the technology object must be enabled.

Enabling is performed using the Motion Control instruction "MC_Power".

The "MC_Power.Status" parameter (<TO>.StatusWord.X0 (Enable)) must show the value "TRUE".

- **Is a technology alarm pending?**

To perform motion commands, no technology alarms or alarm responses may be pending. The "<TO>.ErrorDetail.Number" and "<TO>.ErrorDetail.Reaction" tags of the technology object must show the value zero. After resolving the error, acknowledge any pending alarms using the Motion Control instruction "MC_Reset".

You can find a list of the technology alarms and alarm reactions in the "Technology alarms (Page 140)" appendix.

- **Has the technology object been homed?**

In order to perform a job for absolute positioning, the positioning axis/synchronous axis technology object must be homed. The referencing occurs via the Motion Control instruction "MC_Home". The "<TO>.StatusWord.X5 (HomingDone)" tag of the technology object must show the value "TRUE".

2. Initiate new command for the technology object

In the "Position" parameter of the "MC_MoveAbsolute" instruction, specify the position to which the axis should be moved. Start the job with a positive edge at the "Execute" parameter.

3. Check command status

Parameter "Done" of the Motion Control instruction indicates successful completion of a job (target reached, in this case).

If an error is detected, the "Error" parameter of the Motion Control instruction is set to "TRUE", and the job is rejected.

You can program an error handling routine for the Motion Control job. For this purpose, evaluate the error indicated in the "Error" parameter. The cause of the error is indicated in the ErrorID parameter. After resolving the cause of the error, restart the job.

If "Error" = TRUE and "ErrorID" = 16#8001 is indicated during job execution, a technology alarm has occurred.

You can find a list of the ErrorIDs in the "Error detection (Page 171)" appendix.

Additional information

An option for evaluating the individual status bits, error bits, and warning bits can be found in the Evaluating StatusWord, ErrorWord and WarningWord (Page 101) section.

6.4 Tracking active jobs (S7-1500, S7-1500T)

The current status of the job processing is made available via the output parameters of the Motion Control instruction. These parameters are updated with each call of the Motion Control instruction.

When tracking jobs, a distinction is made between three groups:

- Motion Control instructions with "Done" parameter (Page 114)
- Motion Control instructions without "Done" parameter (Page 119)
- Motion Control instruction "MC_MoveJog" (Page 123)

6.4.1 Motion Control instructions with "Done" parameter (S7-1500, S7-1500T)

Jobs of Motion Control instructions with the "Done" parameter are started with a positive edge at the "Execute" parameter. If the job was completed without errors or interruption by another job (e.g. "MC_MoveAbsolute": Target position reached), the "Done" parameter shows the value "TRUE".

In positioning instructions, the parameter "Done" is delayed by the set minimum dwell time (<TO>.PositioningMonitoring.MinDwellTime).

The following Motion Control instructions have a "Done" parameter for the S7-1500 CPU:

- MC_Reset
- MC_Home
- MC_Halt
- MC_MoveAbsolute
- MC_MoveRelative
- MC_MoveSuperimposed
- MC_SetSensor (S7-1500T)
- MC_Stop
- MC_SetAxisSTW
- MC_WriteParameter
- MC_MeasuringInput
- MC_AbortMeasuringInput
- MC_PhasingRelative (S7-1500T)
- MC_PhasingAbsolute (S7-1500T)
- MC_InterpolateCam (S7-1500T)
- MC_GetCamLeadingValue (S7-1500T)
- MC_GetCamFollowingValue (S7-1500T)
- MC_GroupInterrupt (S7-1500T)
- MC_GroupContinue (S7-1500T)

- MC_GroupStop (S7-1500T)
- MC_MoveLinearAbsolute (S7-1500T)
- MC_MoveLinearRelative (S7-1500T)
- MC_MoveCircularAbsolute (S7-1500T)
- MC_MoveCircularRelative (S7-1500T)
- MC_MoveDirectAbsolute (S7-1500T)
- MC_MoveDirectRelative (S7-1500T)
- MC_TrackConveyorBelt (S7-1500T)
- MC_DefineWorkspaceZone (S7-1500T)
- MC_DefineKinematicsZone (S7-1500T)
- MC_SetWorkspaceZoneActive (S7-1500T)
- MC_SetWorkspaceZoneInactive (S7-1500T)
- MC_SetKinematicsZoneActive (S7-1500T)
- MC_SetKinematicsZoneInactive (S7-1500T)
- MC_DefineTool (S7-1500T)
- MC_SetTool (S7-1500T)
- MC_SetOcsFrame (S7-1500T)

The behavior of the parameters is shown below by way of example for various situations.

Complete execution of the job

If the Motion Control job has been completely executed all the way to the end, this is indicated with parameter "Done" = "TRUE". The signal state of the "Execute" parameter influences the display duration for the "Done" parameter:

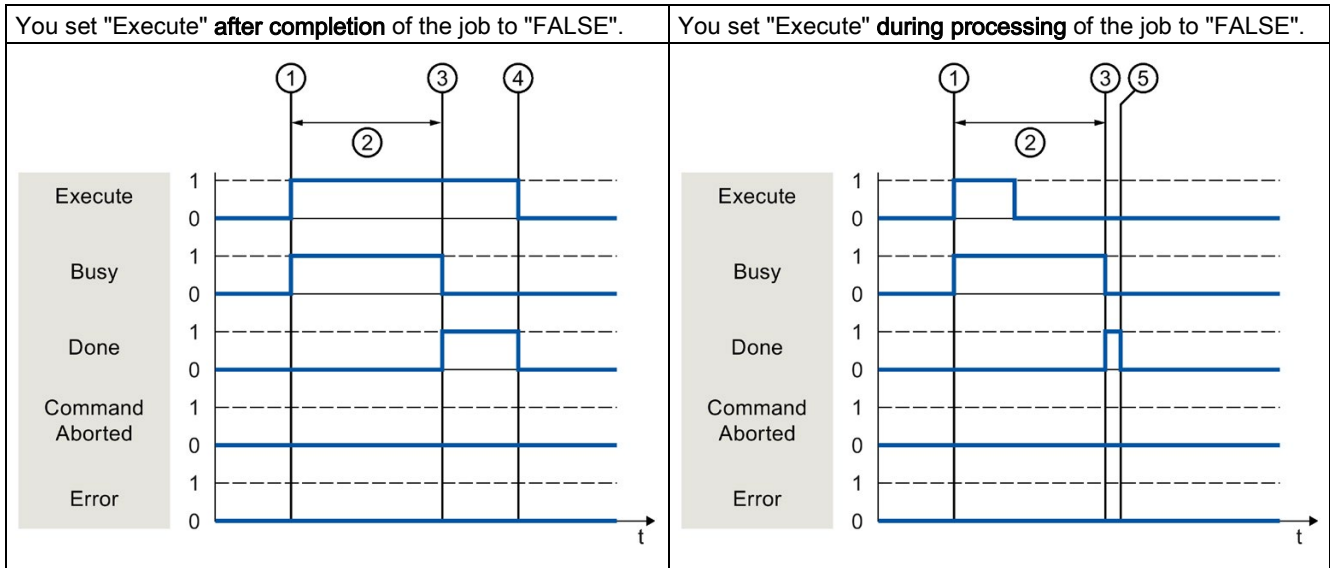

①	The job is started with a positive edge at the "Execute" parameter. Depending on the programming, "Execute" can be reset to the value "FALSE" during the job or the value "TRUE" can be retained until after completion of the job.
②	While the job is being executed, the "Busy" parameter shows the value "TRUE".
③	At the completion of the job (for example, with Motion Control instruction "MC_MoveAbsolute": Target position reached), the "Busy" parameter changes to "FALSE" and the "Done" parameter to "TRUE".
④	As long as the "Execute" parameter retains the value "TRUE" after completion of the job, the "Done" parameter also retains the value "TRUE".
⑤	If the "Execute" parameter was already set to "FALSE" before completion of the job, the "Done" parameter shows the value "TRUE" for only one execution cycle.

Job abort

If the Motion Control job is canceled during processing by another job, this is indicated in the "CommandAborted" parameter with the value "TRUE". The signal state of the "Execute" parameter influences the display duration for the "CommandAborted" parameter:

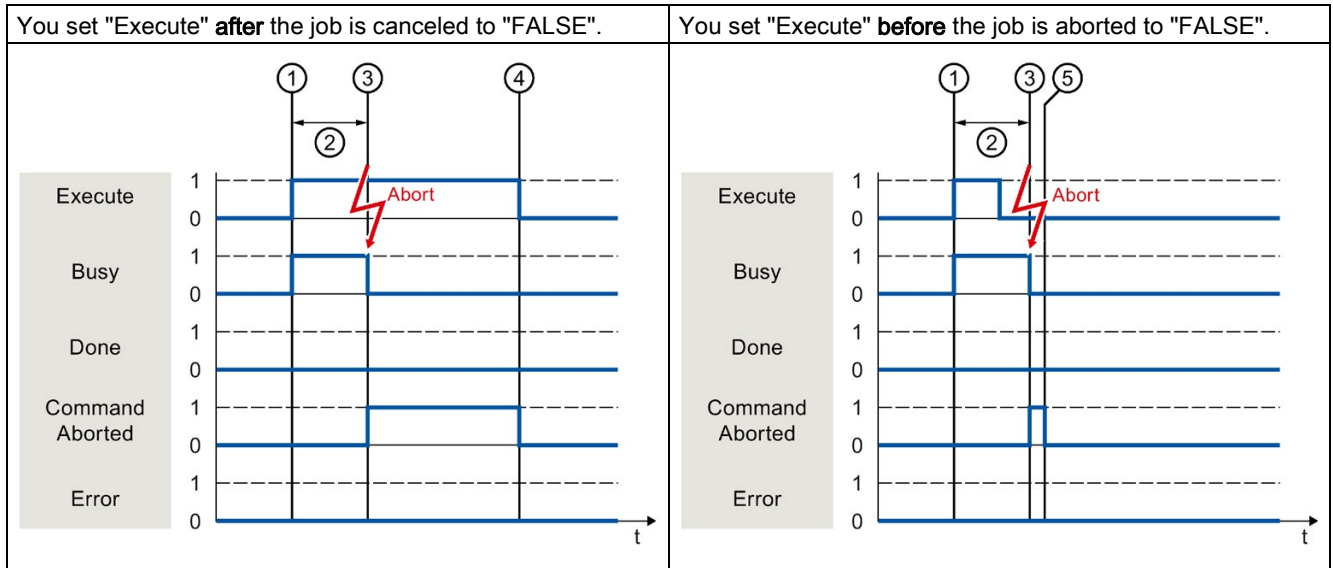

- | | |
|---|---|
| ① | The job is started with a positive edge at the "Execute" parameter. Depending on the programming, "Execute" can be reset to the value "FALSE" during the job or the value "TRUE" can be retained until after completion of the job. |
| ② | While the job is being executed, the parameter "Busy" shows the value "TRUE". |
| ③ | During job execution, the job is aborted by another Motion Control job. When the job is aborted, the "Busy" parameter changes to "FALSE" and "CommandAborted" changes to "TRUE". |
| ④ | As long as the "Execute" parameter retains the value "TRUE" after completion of the job, the "CommandAborted" parameter also retains the value "TRUE". |
| ⑤ | If the "Execute" parameter was already set to "FALSE" before the job is aborted, the "CommandAborted" parameter shows the value "TRUE" for only one execution cycle. |

Error during job execution

If an error occurs during execution of the Motion Control job, this is indicated with parameter "Error" = "TRUE". The signal state of the "Execute" parameter influences the display duration for the "Error" parameter:

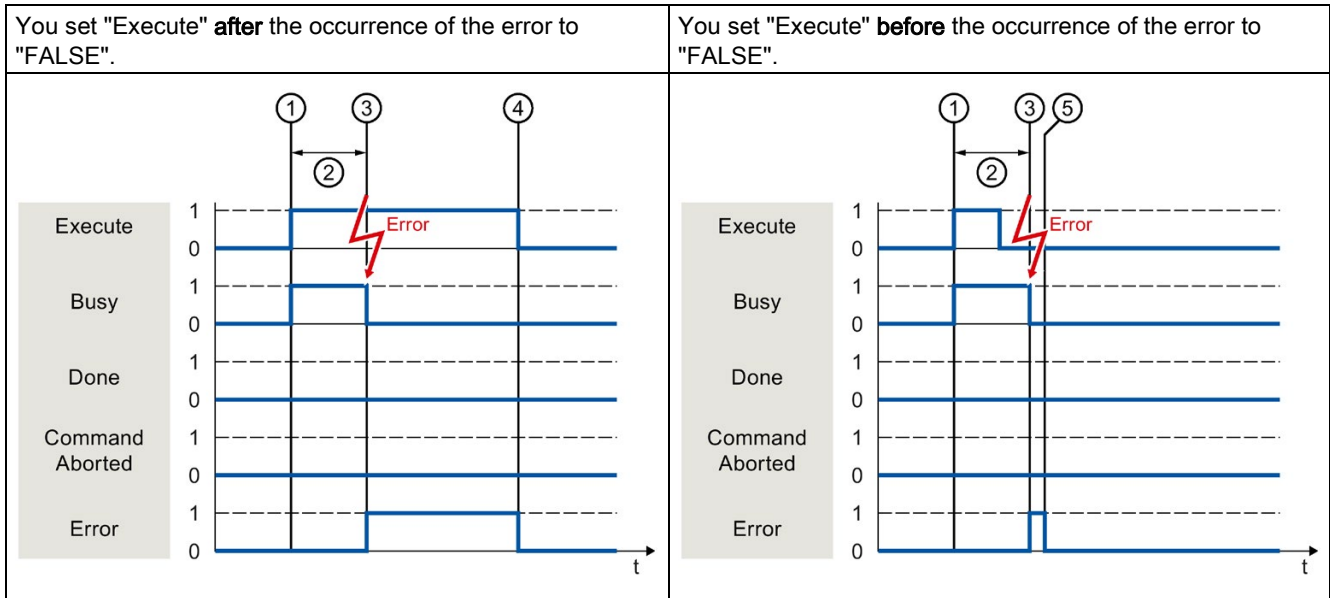

- | | |
|---|--|
| ① | The job is started with a positive edge at the "Execute" parameter. Depending on the programming, "Execute" can be reset to the value "FALSE" during the job or the value "TRUE" can be retained until after completion of the job |
| ② | While the job is being executed, the "Busy" parameter shows the value "TRUE". |
| ③ | An error occurs during the execution of the job. When the error occurs, the "Busy" parameter changes to "FALSE" and the "Error" parameter to "TRUE". |
| ④ | As long as the "Execute" parameter retains the value "TRUE" after the occurrence of the error, the "Error" parameter also retains the value "TRUE". |
| ⑤ | If the "Execute" parameter was already set to "FALSE" before the occurrence of the error, the "Error" parameter shows the value "TRUE" for only one execution cycle. |

Motion Control instructions

You can find additional information on the Motion Control instructions of the Kinematics technology object in the "S7-1500T Kinematics functions" documentation (<https://support.industry.siemens.com/cs/ww/en/view/109766463>).

6.4.2 Motion Control instructions without "Done" parameter (S7-1500, S7-1500T)

Motion Control instructions without the "Done" parameter use a special parameter to indicate that the job objective (e.g. "InVelocity", "InGear") has been achieved. The target state or motion is stopped until the job is aborted or an error occurs.

The following Motion Control instructions have a special parameter for indicating the job status:

Motion Control instruction	Parameter	Validity	
		S7-1500	S7-1500T
MC_Power	Status	X	X
MC_MoveVelocity	InVelocity	X	X
MC_MoveJog	InVelocity	X	X
MC_GearIn	InGear	X	X
MC_GearInPos	InSync	-	X
MC_CamIn	InSync	-	X
MC_SynchronizedMotionSimulation	InSimulation	-	X
MC_LeadingValueAdditive	Busy	-	X
MC_MotionInVelocity	Busy	-	X
MC_MotionInPosition	Busy	-	X
MC_TorqueLimiting	InClamping and InLimitation	-	X
MC_KinematicsTransformation	Busy and Valid	-	X
MC_InverseKinematicsTransformation	Busy and Valid	-	X

The following Motion Control instructions have no special parameter for indicating the job status: Feedback is provided via the following tags:

Motion Control instruction	Parameter	Description
MC_MeasuringInputCyclic	Busy	The execution of a measuring job is indicated with parameter "Busy" = "TRUE". Completed measuring events are indicated in the corresponding event counters "<TO>.MeasuredValues.MeasuredValue1 Counter" and "<TO>.MeasuredValues.MeasuredValue2 Counter" of the technology data block.
MC_OutputCam	Busy	The execution of a job is indicated with parameter "Busy" = "TRUE". The CamOutput tag in the associated technology data block indicates the switching state of the output cam.
MC_CamTrack	Busy	The execution of a job is indicated with parameter "Busy" = "TRUE". The TrackOutput tag in the associated technology data block indicates the switching state of the output cam.

The behavior of the parameter is shown for various situations using the Motion Control instruction "MC_MoveVelocity" as an example:

Example "MC_MoveVelocity"

An "MC_MoveVelocity" job is started with a positive edge at the "Execute" parameter. The job objective is fulfilled when the assigned velocity is reached and the axis travels at constant velocity. When the assigned velocity is reached and maintained, this is indicated in the "InVelocity" parameter with the value "TRUE".

The motion of the axis can, for example, be stopped with an "MC_Halt" job.

The assigned velocity is reached and maintained

Reaching of the assigned velocity is indicated with parameter "InVelocity" = "TRUE". The "Execute" parameter has no effect on the display duration for the "InVelocity" parameter.

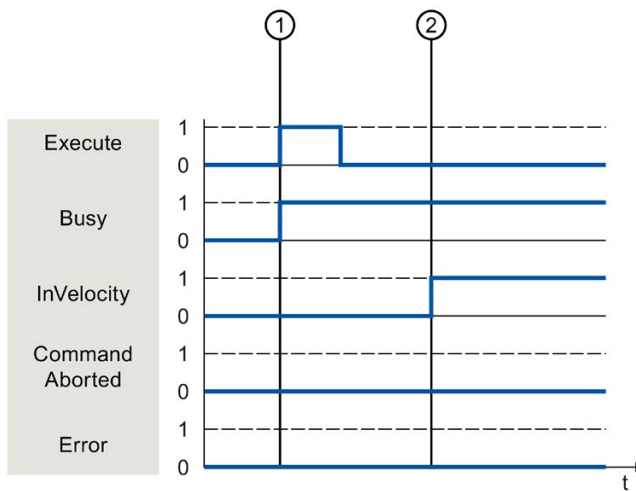

①	The job is started with a positive edge at the "Execute" parameter. Depending on the programming, "Execute" can be reset to the "FALSE" value before or after the parameterized velocity has been reached. While the job is being executed, the parameter "Busy" shows the value "TRUE".
②	When the assigned velocity is reached, the "InVelocity" parameter changes to "TRUE". The "Busy" and "InVelocity" parameters retain the value "TRUE" until another Motion Control job overrides the "MC_MoveVelocity" job.

The job is aborted before the assigned velocity is reached

If the Motion Control job is canceled by another job before the assigned velocity is reached, this is indicated with parameter "CommandAborted" = "TRUE". The signal state of the "Execute" parameter influences the display duration for the "CommandAborted" parameter.

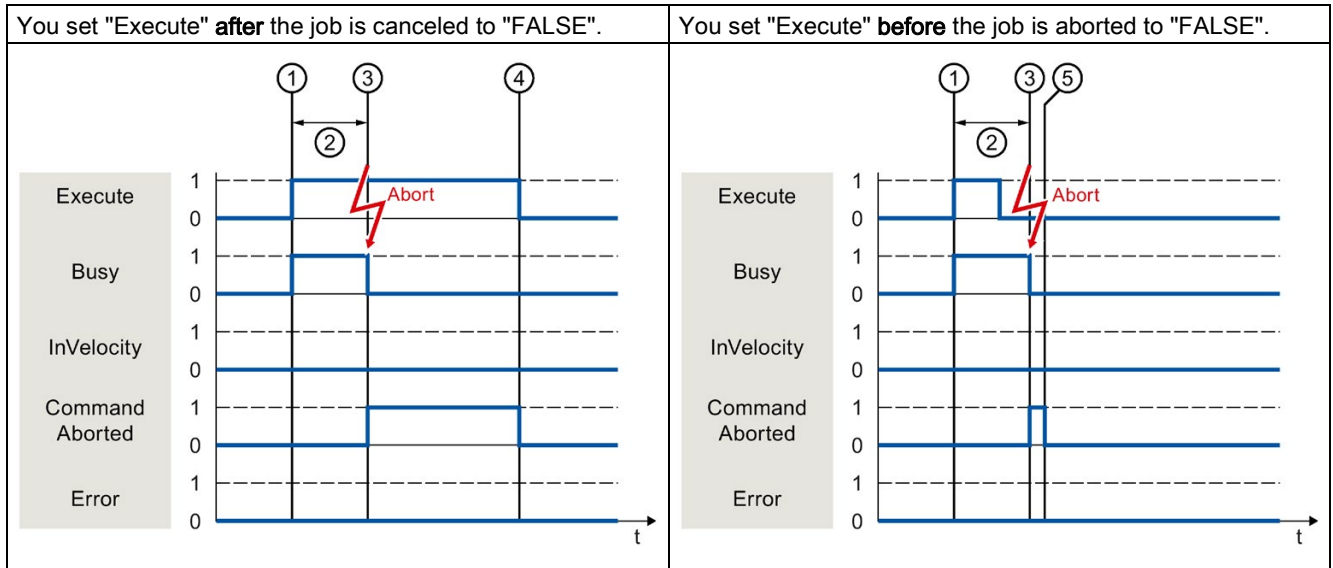

①	The job is started with a positive edge at the "Execute" parameter. Depending on the programming, "Execute" can be reset to the value "FALSE" during the job or the value "TRUE" can be retained until after the job is aborted.
②	While the job is being executed, the "Busy" parameter shows the value "TRUE".
③	During job execution, the job is aborted by another Motion Control job. When the job is aborted, the "Busy" parameter changes to "FALSE" and "CommandAborted" changes to "TRUE".
④	As long as the "Execute" parameter retains the value "TRUE" after completion of the job, the "CommandAborted" parameter also retains the value "TRUE".
⑤	If the "Execute" parameter was already set to "FALSE" before the job is aborted, the "CommandAborted" parameter shows the value "TRUE" for only one execution cycle.

An error has occurred prior to reaching the assigned velocity

If an error occurs during execution of the Motion Control job before the assigned velocity has been reached, this is indicated with parameter "Error" = "TRUE". The signal state of the "Execute" parameter influences the display duration for the "Error" parameter.

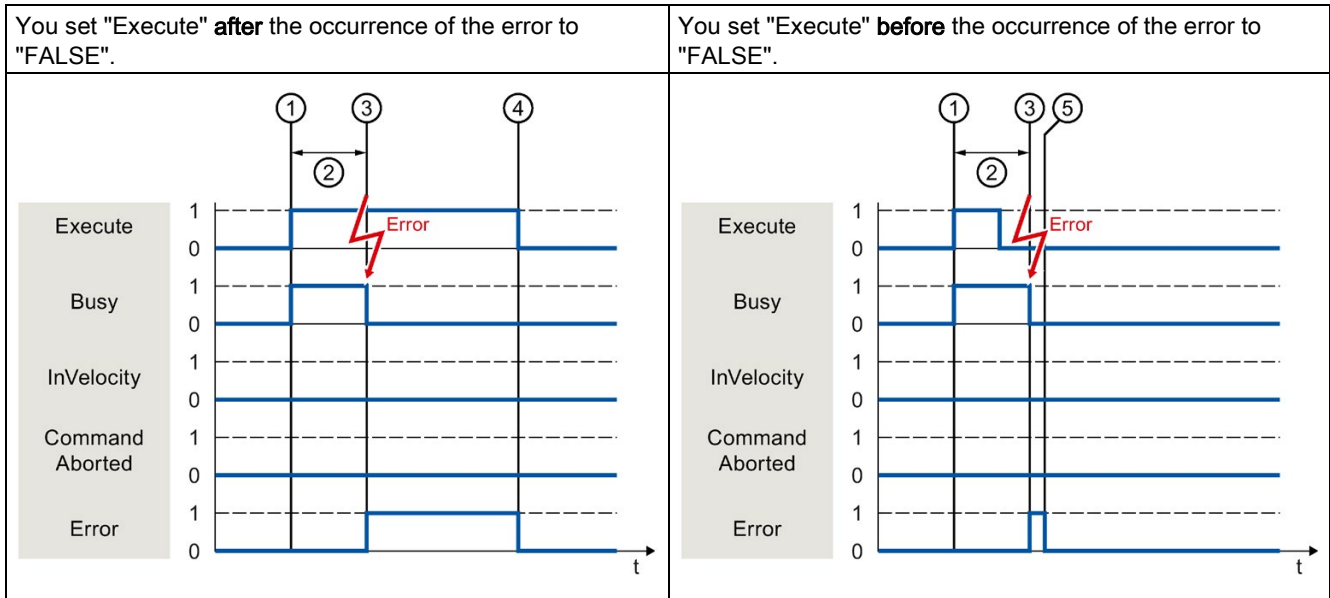

①	The job is started with a positive edge at the "Execute" parameter. Depending on the programming, "Execute" can be reset to the value "FALSE" during the job or the value "TRUE" can be retained until after the error has occurred.
②	While the job is being executed, the "Busy" parameter shows the value "TRUE".
③	An error occurs during the execution of the job. When the error occurs, the "Busy" parameter changes to "FALSE", and the "Error" parameter to "TRUE".
④	As long as the "Execute" parameter retains the value "TRUE" after completion of the job, the "Error" parameter also retains the value "TRUE".
⑤	If the "Execute" parameter was already set to "FALSE" before the job is aborted, the "Error" parameter shows the value "TRUE" for only one execution cycle.

Motion Control instructions

You can find additional information on the Motion Control instructions of the Kinematics technology object in the "S7-1500T Kinematics functions" documentation (<https://support.industry.siemens.com/cs/ww/en/view/109766463>).

6.4.3 Motion Control instruction "MC_MoveJog" (S7-1500, S7-1500T)

An "MC_MoveJog" job is started by setting the "JogForward" or "JogBackward" parameter. The job objective is fulfilled when the assigned velocity is reached and the axis travels at constant velocity. When the assigned velocity is reached and maintained, this is indicated in the "InVelocity" parameter with the value "TRUE".

The job is complete when the "JogForward" or "JogBackward" parameter has been set to the value "FALSE" and the axis has come to a standstill.

The behavior of the parameters in various situations is shown below by way of example.

The assigned velocity is reached and maintained

If the Motion Control job has been performed up to the point of reaching the assigned velocity, then this is indicated in the "InVelocity" parameter with the value "TRUE".

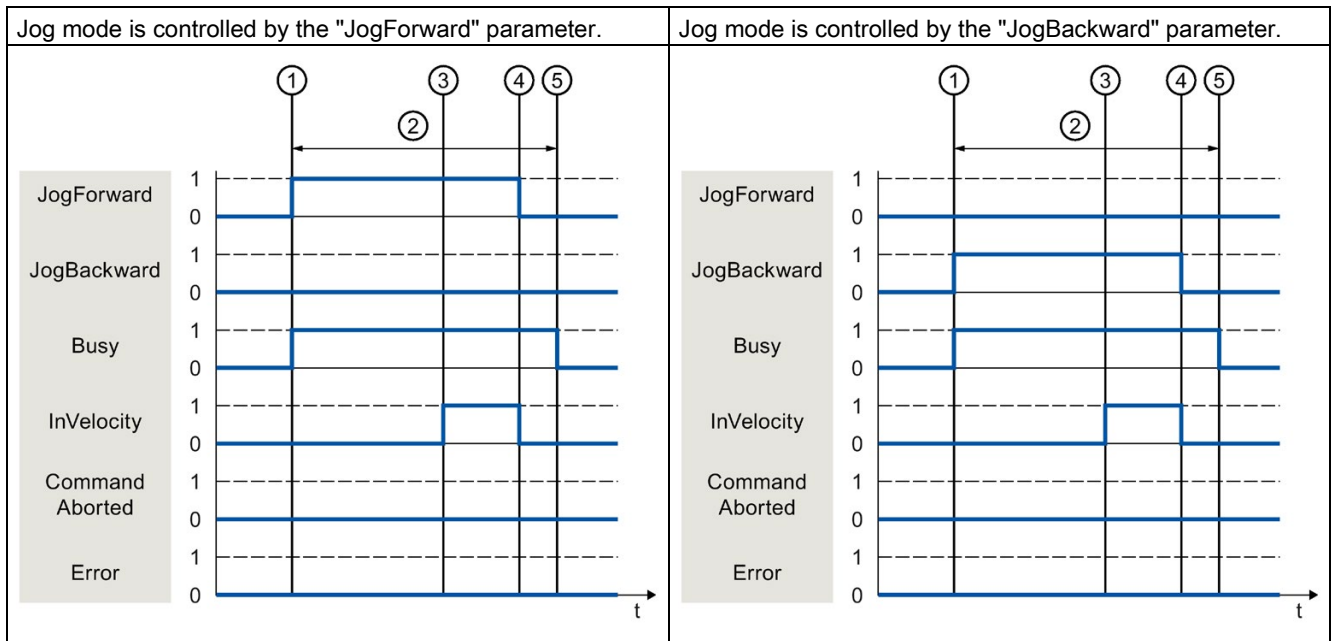

①	The job is started by setting the "JogForward" or "JogBackward" parameter.
②	While the job is being executed, the "Busy" parameter shows the value "TRUE".
③	When the assigned velocity is reached, the "InVelocity" parameter changes to "TRUE".
④	When the "JogForward" or "JogBackward" parameter is reset, the motion of the axis ends. The axis decelerates. The "InVelocity" parameter changes to "FALSE".
⑤	If the axis has come to a standstill, then the Motion Control job is complete and the "Busy" parameter changes to "FALSE".

The job is aborted during execution

If the Motion Control job is canceled during processing by another job, this is indicated in the "CommandAborted" parameter with the value "TRUE". The behavior of the "CommandAborted" parameter is independent of reaching the assigned velocity.

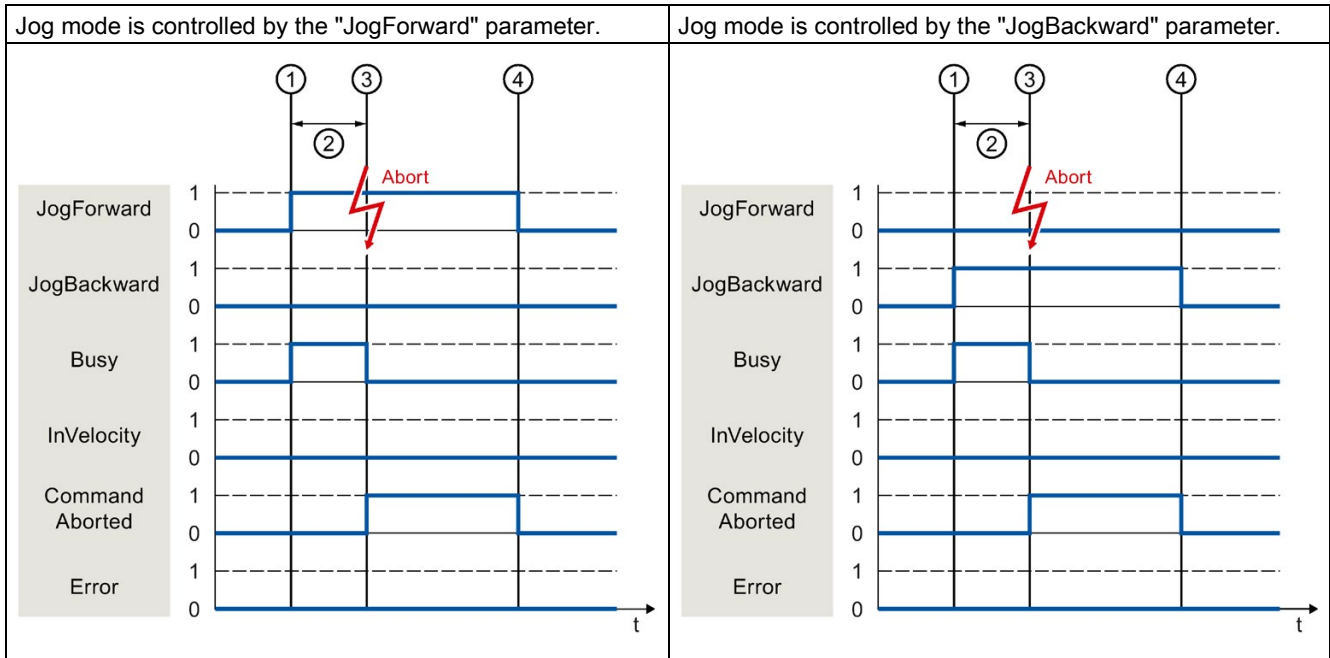

①	The job is started by setting the "JogForward" or "JogBackward" parameter.
②	While the job is processing, the "Busy" parameter shows the value "TRUE".
③	During job execution, the job is aborted by another Motion Control job. When the job is aborted, the "Busy" parameter changes to "FALSE" and "CommandAborted" changes to "TRUE".
④	When the "JogForward" or "JogBackward" parameter is reset, the "CommandAborted" parameter likewise changes to "FALSE".

An error occurs during the execution of the job

If an error occurs during execution of the Motion Control job, this is indicated in the "Error" parameter with the value "TRUE". The behavior of the "Error" parameter is independent of reaching the assigned velocity.

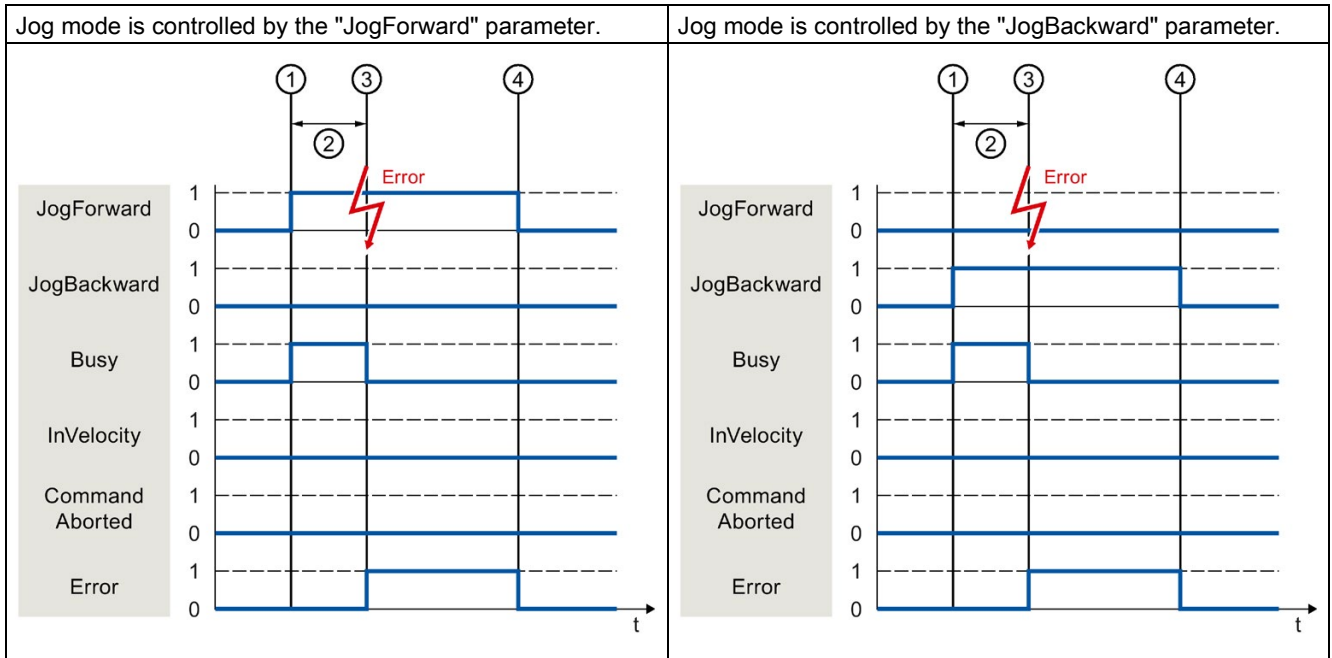

①	The job is started by setting the "JogForward" or "JogBackward" parameter.
②	While the job is being executed, the "Busy" parameter shows the value "TRUE".
③	An error occurs during the execution of the job. When the error occurs, the "Busy" parameter changes to "FALSE", and "Error" changes to "TRUE".
④	When the "JogForward" or "JogBackward" is reset to the value "FALSE", the "Error" parameter likewise changes to "FALSE".

6.5 Ending Motion Control jobs (S7-1500, S7-1500T)

When a job is ended, a distinction is made between error-free completion of the job and a motion abort.

Completion of job

The completion of a Motion Control job is indicated as described in the "Tracking running jobs (Page 114)" section.

Job termination

The termination and the substitution behavior are described in the section "Substitution behavior of Motion Control jobs". Special pending jobs can be cancelled with "MC_Power".

Motion abort

If a motion must be aborted, you can perform the following measures:

- Execute "MC_Halt" or "MC_Stop"

To abort a motion and stop the axis, you can use the "MC_Halt" instruction or "MC_Stop" instruction.

- Disable "MC_Power"

In an emergency, you can stop the axis via an emergency stop ramp. To do so, set the "Enable" parameter of the "MC_Power" instruction to "FALSE". The axis is decelerated according to the selected "StopMode" and all jobs for the technology object are aborted.

Measuring job abort

With the Motion Control instruction "MC_AbortMeasuringInput", an active one-time or cyclic measuring job is aborted.

Cancellation of an active output cam/cam track

- "MC_OutputCam"

An active output cam is disabled when the "Enable" parameter of Motion Control instruction "MC_OutputCam" is set to "FALSE".

- "MC_CamTrack"

An active cam track is disabled when the "Enable" parameter of Motion Control instruction "MC_CamTrack" is set to "FALSE".

6.6 Restart of technology objects (S7-1500, S7-1500T)

After the CPU is switched on, or after technology objects are downloaded into the CPU, the system automatically initializes the technology objects with the start values from the technology data block. If restart-relevant changes are detected during a reload into the CPU, a restart of the technology object is automatically performed.

If restart-relevant data have been changed in RUN mode by the user program, then the technology object must be reinitialized by the user in order for the changes to be used. At a RUN → STOP transition, the CPU automatically performs a restart of technology objects with restart-relevant changes.

If changes in the technology data block should also be retained after the restart of the technology object, then you must write the changes to the start value in load memory using the extended instruction "WRIT_DBL".

Restart required

If a restart of the technology object is required, this is indicated at "Technology object > Diagnostics > Status and error bits > Axis status or Encoder status > Online start value changed", as well as in the tag "<TO>.StatusWord.X3 (OnlineStartValuesChanged)" of the technology object.

Restarting a technology object

A restart of the technology object is triggered by the user by means of the "MC_Reset" Motion Control instruction, with parameter "Restart" = TRUE.

During a restart, all configuration data of the technology object are loaded from load memory into work memory. In the process, the actual values in the technology data block are overwritten.

Note the following during a restart of the technology object:

- A restart resets the "Homed" status of a technology object with incremental actual values ("<TO>.StatusWord.X5 (HomingDone)").
- While a restart is being performed, the technology object cannot perform any jobs. An active restart will be indicated under "Technology object > Diagnostics > Status and error bits > Axis status or Encoder status > Restart active", and in the "<TO>.StatusWord.X2 (RestartActive)" tag of the technology object.
- Motion Control jobs are rejected during a restart with the "Error" = TRUE and "ErrorID" = 16#800D parameters (job not executable, because a restart is active).
- While a restart is being executed, you cannot access the technology data block.

See also

Change restart-relevant data (Page 103)

Downloading to CPU (S7-1500, S7-1500T)

When downloading to the CPU S7-1500, it is always verified that the project files are consistent online and offline after the download.

The data of the technology objects are saved in technology data blocks. The conditions for downloading blocks thus apply when loading new or modified technology objects.

Load in RUN mode

When loading in the CPU's RUN mode, it is checked whether a load without restart of the technology objects is possible.

If restart-relevant configuration values were changed, then a restart of the technology object is automatically performed after the load into the CPU.

Loading a technology object is only possible if the technology object is disabled.

You **cannot** download the following changes to the CPU in RUN mode:

- Changes to the MC-Servo clock speeds
- Changes to the hardware interface of the technology object in "Technology object > Configuration > Hardware interface"

Commissioning (S7-1500, S7-1500T)

The following guidelines describe the steps that you should note when commissioning the Motion Control-specific components of your equipment.

The commissioning of other components of your automation system depends on the particular equipment configuration. Commissioning (not Motion Control) is described in the "Automation System S7-1500"

(<https://support.automation.siemens.com/WW/view/en/59191792>) system manual.

8.1 Commissioning guidelines (S7-1500, S7-1500T)

These guidelines serve as recommendations for commissioning equipment with Motion Control. The procedure is described using the example of a positioning axis technology object.

Requirement

- The configuration of the following components is complete:
 - CPU
 - BUS communication
 - Drives
 - Technology objects
- The user program has been created.
- The wiring of the CPU and of the associated I/O is complete.
- The commissioning and optimization of the drive is complete.

Procedure

Proceed as follows to commission the Motion Control-specific components of your equipment:

Step	Action to be performed	Supported by TIA Portal
Turn on CPU	Turn on the power supply and the CPU.	-
"Disable" position controller	Set the gain (Kv factor) of the position control loop to zero. (This setting avoids unwanted drive movements that may be caused by incorrect parameterization of the position control loop.)	"Technology object > Configuration > Extended parameters > Control loop"
Activate precontrol	Set the precontrol to 100 %.	"Technology object > Configuration > Extended parameters > Control loop"
Load project into the CPU	Bring the CPU to the STOP mode. Download your project to the CPU (load hardware and software).	<ul style="list-style-type: none"> "Toolbar > Stop CPU" "Toolbar > Download to device"
Create online connection to the CPU	Select the "Receive messages" check box under "Online & Diagnostics > Online Access". Configure the interface of the TIA Portal and create an online connection with the CPU.	<ul style="list-style-type: none"> Device configuration "Online & Diagnostics > Online Access"
Disable Motion Control specific user program	In order to avoid conflicts with the axis control panel, lock the enabling of technology objects in your user program (MC_Power.Enable = FALSE).	<ul style="list-style-type: none"> PLC programming Motion Control instructions
Evaluating pending messages	Evaluate the message display in the inspector window. Resolve the causes of pending technology alarms. Acknowledge the technology alarms (Page 135).	"Inspector window > Diagnostics > Message display"
Check hardware limit switches	Click the hardware limit switches. Check for correct message display (technology alarm 531). Acknowledge the technology alarm.	"Inspector window > Diagnostics > Message display"
Check the connection and configuration of the drive (setpoint)	Bring the CPU into the RUN mode. Open the Axis control panel and take over control. Perform the following steps: <ul style="list-style-type: none"> Enable the technology object. ⇒ The drive must turn itself on, and where applicable release the brake. The position is held. Move the axis in jog mode at low velocity in the positive direction. ⇒ The drive must move. The actual position value must increase (positive direction). Disable the technology object. ⇒ The drive must turn itself off, and where applicable apply the brake. 	"Technology object > Commissioning > Axis control panel"

8.1 Commissioning guidelines (S7-1500, S7-1500T)

Step	Action to be performed	Supported by TIA Portal
Check the connection and configuration of the encoder (actual value)	<ul style="list-style-type: none"> Check the scaling of the actual values (rotation direction, distance evaluation, and resolution of the encoder) ⇒ The change in the actual mechanical position must match the change in the actual values. In case of deviations, correct the parameters assigned for mechanics under "Technology object > Extended parameters > Mechanics". For absolute encoders, check the absolute encoder adjustment. To do this, move the axis to the start of the traversing range and switch the system off. After the restart, check the actual encoder values for correctness. Repeat this step likewise at the traversing range end. If there are deviations, correct the following: <ul style="list-style-type: none"> Settings for fine resolution under "Technology object > Data exchange with encoder" Zero-crossing position of the encoder (only for "Absolute" encoder type) <p>The position of the zero crossing can be changed by rotating the encoder in the dismantled state. With programmable encoders, the zero crossing can be adjusted by parameter assignment. The zero crossing must be outside the traversing range.</p> 	<ul style="list-style-type: none"> "Technology object > Diagnostics > PROFIdrive telegram" "Technology object > Commissioning > Axis control panel"
Checking the reference speed	<p>Traverse the axis in jog mode at low velocity in the positive direction. ⇒ The displayed current velocity must match the velocity setpoint. If the displayed current velocity deviates significantly from the velocity setpoint, adjust the reference speed.</p>	<ul style="list-style-type: none"> "Technology object > Hardware interface > Data exchange" "Technology object > Commissioning > Axis control panel"
Optimize position controller	<p>Use the Optimization commissioning function to optimize the gain (Kv) of the position control loop. For this purpose, adapt following error limits as needed.</p>	"Technology object > Commissioning > Optimization"
Transfer the gain Kv to the project.	<p>Enter the gain Kv that you determined by means of the optimization function in your configuration data. Load your project into the CPU.</p>	"Technology object > Configuration > Extended parameters > Control loop"
Enable Motion Control specific user program	<p>Unlock the enabling technology objects lock in your user program (MC_Power.Enable = TRUE).</p>	<ul style="list-style-type: none"> PLC programming Motion Control instructions
Check the functioning of the user program	<p>Check the programmed functions of your user program.</p>	<ul style="list-style-type: none"> Watch and force tables Online and diagnostic functions
End of commissioning for a positioning axis technology object	<p>To commission additional technology objects, perform the corresponding steps again.</p>	See above.

See also

S7-1500/S7-1500T Axis functions
<https://support.industry.siemens.com/cs/ww/en/view/109766462>

Diagnostics (S7-1500, S7-1500T)

The "Diagnostics" section is limited to the description of the diagnostic concept for Motion Control.

A comprehensive description of the system diagnostics of the S7-1500 CPU can be found in the "Diagnostics" function manual (<https://support.industry.siemens.com/cs/ww/en/view/59192926>).

9.1 Diagnostic concept (S7-1500, S7-1500T)

The diagnostic concept encompasses alarms and associated messages, as well as error messages in the Motion Control instructions. The TIA Portal also supports you with consistency checks during configuration of the technology objects, and during the creation of your user program.

All alarms in runtime (from the CPU, technology, hardware etc.) are displayed in the Inspector window of the TIA Portal. Diagnostic information that relates to technology objects (technology alarms, status information) are additionally displayed in the Diagnostics window of the respective technology object.

During motion control, if an error occurs at a technology object (e.g. approaching a hardware limit switch), then a technology alarm (Page 135) is triggered, and a corresponding message is displayed in the TIA Portal as well as on HMI devices.

In your user program, technology alarms are generally signaled via error bits in the technology data block. The number of the technology alarm with the highest priority is also displayed. In order to simplify error evaluation, the "Error" and "ErrorID" parameters of the Motion Control instructions also indicate that a technology alarm is pending.

Program errors (Page 139) can occur during parameter assignment or during the processing sequence of the Motion Control instructions (e.g. invalid parameter specification when calling the instruction, initiation of a job without enable via "MC_Power"). Motion Control instruction errors are indicated at the call of instructions using the "Error" and "ErrorID" parameters.

9.2 Technology alarms (S7-1500, S7-1500T)

If an error occurs at a technology object (e.g. approaching a hardware limit switch), a technology alarm is triggered and indicated. The impact of a technology alarm on the technology object is specified by the alarm reaction.

Alarm classes

Technology alarms are divided into three classes:

- **Acknowledgeable warning**

The processing of Motion Control job is continued. The current motion of the axis can be influenced, e.g. by limiting the current dynamic values to the configured limit values.

- **Alarm requiring acknowledgment**

Motion jobs are aborted in accordance with the alarm reaction. You must acknowledge the alarms in order to continue execution of new jobs after eliminating the cause of the error.

- **Fatal error**

Motion jobs are aborted in accordance with the alarm reaction.

To be able to use the technology object again after eliminating the cause of the error, you must restart the technology object (Page 127).

Display of technology alarms

A technology alarm is displayed in the following locations:

- **TIA Portal**

- **"Technology object > Diagnostics > Status and error bits"**

Display of pending technology alarms for each technology object.

- **"Technology object > Commissioning > Axis control panel"**

Display of the last pending technology alarm for each technology object.

- **"Inspector window > Diagnostics > Message display"**

Select the "Receive messages" check box under "Online & Diagnostics > Online Access" in order to display technology alarms via the message display.

With an online connection to the CPU, the pending technology alarms for all technology objects are displayed. Additionally, the archive view is available to you.

The message display can also be activated and displayed on a connected HMI.

- **"CPU > Online & diagnostics"**

Display of the technology alarms that have been entered in the diagnostic buffer.

- **User program**

- **Tags "<TO>.ErrorDetail.Number" and "<TO>.ErrorDetail.Reaction"**

Indication of the number and the reaction of the technology alarm with the highest priority.

- **Tag "<TO>.StatusWord"**

A pending technology alarm is indicated with bit 1 ("Error").

- **Tag "<TO>.ErrorWord"**

Indication of alarms and fatal errors.

- **Tag "<TO>.WarningWord"**

Indication of warnings.

- **Parameter "Error" and "ErrorID"**

In a Motion Control instruction, the parameters "Error" = TRUE and "ErrorID" = 16#8001 indicate that a technology alarm is pending.

- **Display of the CPU**

In order to show technology alarms on the CPU display, make the following setting when loading to the CPU:

In the "Load preview" dialog, select the action "Consistent download" for the "Text libraries" entry.

Alarm reaction

A technology alarm always contains an alarm reaction, which describes the impact on the technology object. The alarm reaction is specified by the system.

The following table shows possible alarm reactions:

Alarm reaction	Description
Axes (speed axis, positioning axis, synchronous axis)	
No reaction (warnings only) <TO>.ErrorDetail.Reaction = 0	The processing of Motion Control job is continued. The current motion of the axis can be influenced, e.g. by limiting the current dynamic values to the configured limit values.
Stop with current dynamic values <TO>.ErrorDetail.Reaction = 1	Active motion commands are aborted. The axis is braked with the dynamic values that present in the Motion Control instruction and brought to a standstill.
Stop with maximum dynamic values <TO>.ErrorDetail.Reaction = 2	Active motion commands are aborted. The axis is braked with the dynamic values configured under "Technology object > Extended parameters > Dynamic limits", and brought to a standstill. The configured maximum jerk is hereby taken into account.
Stop with emergency stop ramp <TO>.ErrorDetail.Reaction = 3	Active motion commands are aborted. The axis is braked with the emergency stop deceleration configured under "Technology object > Extended parameters > Emergency stop ramp", without any jerk limit, and brought to a standstill.
Remove enable <TO>.ErrorDetail.Reaction = 4	Active motion commands are aborted. The setpoint zero is output and the enable is removed. The axis is braked to a standstill according to the configuration in the drive.
Track setpoints <TO>.ErrorDetail.Reaction = 5	Active motion commands are aborted. The setpoint zero is output. The actual values supplied by the drive are automatically tracked as setpoints.
Other technology objects (output cam, cam track, measuring input, cam, external encoder)	
No reaction (warnings only) <TO>.ErrorDetail.Reaction = 0	The processing of Motion Control job is continued. The current motion of the axis can be influenced, e.g. by limiting the current dynamic values to the configured limit values.
Terminate processing of the technology object: <ul style="list-style-type: none"> • Output cam <TO>.ErrorDetail.Reaction = 6 • Cam track <TO>.ErrorDetail.Reaction = 7 • Measuring input <TO>.ErrorDetail.Reaction = 8 • Cam <TO>.ErrorDetail.Reaction = 9 • External encoder <TO>.ErrorDetail.Reaction = 10 	Processing of the technology object is terminated. All running Motion Control jobs are aborted.

Acknowledging technology alarms

You can acknowledge technology alarms as follows:

- **TIA Portal**

- **"Technology object > Commissioning > Axis control panel"**

Click "Confirm" to acknowledge all alarms and warnings pending for the selected technology object.

- **"Inspector window > Diagnostics > Message display"**

You can acknowledge the alarms and warnings for all technology objects either individually, or all at once.

- **HMI**

At an HMI with enabled message display, you can acknowledge the alarms and warnings for all technology objects either individually, or all at once.

- **User program**

Acknowledge pending technology alarms for a technology object with the Motion Control instruction "MC_Reset".

Additional information

You can find a list of the technology alarms and alarm reactions in the "Technology alarms (Page 140)" appendix.

9.3 Errors in Motion Control instructions (S7-1500, S7-1500T)

Errors in Motion Control instructions (e.g. invalid parameter value setting) are indicated by the "Error" and "ErrorID" output parameters.

Under the following conditions, "Error" = TRUE and "ErrorID" = 16#8xxx are indicated for the Motion Control instruction:

- Illegal status of the technology object, which prevents the execution of the job.
- Invalid parameter assignment of the Motion Control instruction, which prevents the execution of the job.
- As a result of the alarm reaction for a technology object error.

Error display

If there is a Motion Control instruction error, the "Error" parameter shows the value "TRUE". The cause of the error is given in the "ErrorID" parameter.

Jobs to the technology object are rejected when "Error" = TRUE. Running jobs are not influenced by rejected jobs.

If "Error" = TRUE and "ErrorID" = 16#8001 is indicated during job execution, a technology alarm has occurred. In this case, evaluate the indication of the technology alarm.

If "Error" = "TRUE " is displayed during execution of a "MC_MoveJog" job, the axis is braked and brought to a standstill. In this case, the deceleration configured for the "MC_MoveJog" instruction takes effect.

Acknowledge error

Acknowledging errors in Motion Control instructions is not required.

Restart a job after resolving the error.

Additional information

You can find a list of the ErrorIDs in the "Error detection (Page 171)" appendix.

Appendix (S7-1500, S7-1500T)

A.1 Technology alarms (S7-1500, S7-1500T)

A.1.1 Overview of the technology alarms (S7-1500, S7-1500T)

The following table shows an overview of the technology alarms and the corresponding alarm reactions. When a technology alarm occurs, evaluate the entire indicated alarm text, in order to find the precise cause.

Legend

No.	Number of the technology alarm (corresponds to <TO>.ErrorDetail.Number)
Reaction	Effective alarm reaction (corresponds to <TO>.ErrorDetail.Reaction)
Error bit	Bit that is set in "<TO>.ErrorWord" when the technology alarm occurs A description of the bits can be found in the appendix of the documentation "S7-1500/S7-1500T Axis functions" (https://support.industry.siemens.com/cs/ww/en/view/109766462).
Warning bit	Bit that is set in "<TO>.WarningWord" when the technology alarm occurs A description of the bits can be found in the appendix of the documentation "S7-1500/S7-1500T Axis functions" (https://support.industry.siemens.com/cs/ww/en/view/109766462).
Restart	To acknowledge the technology alarm, the technology object must be reinitialized (Restart).
Diagnostic buffer	The alarm is entered in the diagnostics buffer.
Alarm text	Displayed alarm text (limited)

List of the technology alarms

No.	Reaction	Error bit	Warning bit	Restart	Diagnostic buffer	Alarm text
101	Remove enable	X1	-	X	X	Configuration error.
102	Remove enable	X15	-	X	X	Drive configuration adaptation error.
103	Remove enable	X15	-	X	X	Encoder configuration adaptation error.
104	Stop with maximum dynamic values	X1	-	-	-	SW limit switch specification error.
105	Remove enable	X1	-	X	X	Drive configuration error.
106	Remove enable	X1	-	-	X	Drive connection configuration error.
107	Remove enable	X1	-	X	X	Encoder configuration error.
108	Remove enable	X1	-	-	X	Encoder connection configuration error.
109	Remove enable	X1	-	X	-	Configuration error.
110	No reaction	-	X1	-	-	Configuration is adjusted internally.
111	No reaction	-	X15	-	X	TO and drive configuration inconsistent.
112	No reaction	-	X15	-	X	TO and encoder configuration inconsistent.
113	Remove enable	X2	-	X	-	Isochronous mode not possible.
114	Remove enable	X1	-	X	-	Cross-PLC synchronous operation configuration error.
201	Remove enable	X0	-	X	X	Internal error.
202	No reaction	X0	-	X	-	Internal configuration error.
203	Remove enable	X0	-	X	-	Internal error.
204	Remove enable	X0	-	-	-	Commissioning error.
304	Stop with emergency stop ramp	X2	-	-	-	Velocity limit is zero.
305	Stop with emergency stop ramp	X2	-	-	-	<ul style="list-style-type: none"> Limit value of the acceleration is zero. Limit value of the deceleration is zero.
306	Stop with emergency stop ramp	X2	-	-	-	Jerk limit is zero.
307	Stop with maximum dynamic values	X2	-	-	X	<ul style="list-style-type: none"> Negative numerical value range of the position reached. Positive numerical value range of the position reached.
308	Remove enable	X2	-	-	X	<ul style="list-style-type: none"> Negative numerical value range of the position exceeded. Positive numerical value range of the position exceeded.
321	Stop with emergency stop ramp	X3	-	-	-	Axis not homed.
322	No reaction	-	X3	-	-	Restart not executed.
323	Remove enable	X3	-	-	-	MC_Home could not be performed.
341	Stop with maximum dynamic values	X10	-	-	-	Error in homing data.

A.1 Technology alarms (S7-1500, S7-1500T)

No.	Reaction	Error bit	Warning bit	Restart	Diagnostic buffer	Alarm text
342	Stop with emergency stop ramp	X10	-	-	-	Reference output cam/encoder zero mark not found.
343	Remove enable	X1	-	-	-	Homing function not supported by device.
401	Remove enable	X13	-	-	X	Error accessing logical address.
411	Remove enable	X5	-	-	X	Faulty encoder at the logical address.
412	Remove enable	X5	-	-	-	Permitted actual value range exceeded.
421	Remove enable	X4	-	-	X	Faulty drive at the logical address.
431	Remove enable	X7	-	-	X	Faulty communication with device at logical address.
501	No reaction	-	X6	-	-	Programmed velocity is limited.
502	No reaction	-	X6	-	-	<ul style="list-style-type: none"> Programmed acceleration is being limited. Programmed deceleration is being limited.
503	No reaction	-	X6	-	-	Programmed jerk is limited.
504	No reaction	-	X6	-	-	Speed setpoint monitoring active.
511	No reaction	-	X6	-	-	Dynamic limits are violated by the kinematics motion.
521	Remove enable	X11	-	-	-	Following error.
522	No reaction	-	X11	-	-	Warning following error tolerance.
531	Remove enable	X9	-	-	-	<ul style="list-style-type: none"> Positive HW limit switch approached. Negative HW limit switch approached. Illegal free travel direction of active hardware limit switch. HW limit switch polarity reversed, free travel not possible. Both hardware limit switches active, retraction not possible.
533	Stop with maximum dynamic values	X8	-	-	-	<ul style="list-style-type: none"> Negative SW limit switch approached. Positive SW limit switch approached.
534	Remove enable	X8	-	-	-	<ul style="list-style-type: none"> Negative SW limit switch is crossed. Positive SW limit switch is crossed.
541	Remove enable	X12	-	-	-	Position monitoring error.
542	Remove enable	X2	-	-	-	Clamping monitoring error: Axis leaving clamping tolerance window.
550	Track setpoints	X4	-	-	-	Drive-autonomous motion is being executed.
551	No reaction	X2	X6	-	-	Maximum velocity cannot be reached with drive/axis parameters.
552	Remove enable	X15	-	-	-	Encoder adaptation error during ramp-up.
601	Stop with maximum dynamic values	X14	-	-	-	Leading axis is not assigned or defective.

No.	Reaction	Error bit	Warning bit	Restart	Diagnostic buffer	Alarm text
603	Remove enable	X14	-	-	-	Leading axis is not in position-controlled mode.
608	Stop with maximum dynamic values	X14	-	-	-	Error during synchronization.
611	Remove enable	X2	-	-	-	The cam specified in the MC_CamIn.Cam parameter has not been configured or is not available or is not interpolated.
612	Remove enable	X2	-	-	-	Specified cam has not been interpolated.
613	Remove enable	X1	-	-	-	Accuracy of leading value is limited.
700	Remove enable	X2	-	-	-	Output cam limiting error.
701	Remove enable	X13	-	-	-	I/O output error.
702	Remove enable	X2	-	-	-	Position value valid.
703	Remove enable	X2	-	-	-	Cam track data faulty.
704	Remove enable	X2	-	-	-	Output cam data faulty.
750	Remove enable	X2	-	-	-	Measuring job not possible during homing of assigned axis.
752	Remove enable	X2	-	-	-	Validity range of measuring job not recognized.
753	Remove enable	X2	-	-	-	Only one measuring input can access an encoder at a time.
754	Remove enable	X2	-	-	-	Measuring input configuration in external device is not correct.
755	Remove enable	X13	-	-	-	Measuring job not possible.
758	No reaction	X2	-	-	-	A measuring edge was not evaluated.
900	Remove enable	X2	-	X	-	Invalid leading values.
901	Remove enable	X7	-	-	-	Data transmission error
902	Remove enable	X1	-	-	-	Accuracy of leading value is limited.

See also

Technology alarms (Page 135)

A.1.2 Technology alarms 101-114 (S7-1500, S7-1500T)

Technology alarm 101

Alarm reaction: Remove enable

Restart: Required

Alarm text	Remedy
Configuration error.	
Value in <tag> not allowed.	Adjust the specified value.
Faulty load gear factors.	Adjust the load gear factors in the "<TO>.LoadGear.Numerator" and/or "<TO>.LoadGear.Denominator" parameters.
At least one encoder required. Sensor[].existent	Configure at least one encoder.
Sensor[1] must be configured for DSC.	Configure Sensor[1].
Values in Sensor[1..4].Parameter.FineResolutionXist1 and P979 are not identical.	Set the identical fine resolution on the technology as on the drive.
Controller parameter incorrect.	Adjust the value of the "<TO>.PositionController.Kv" parameter.
PROFIBUS parameter assignment is inconsistent; sum Ti and To greater than send clock.	Adjust the send clock in the hardware configuration.
Drive or drive telegram type or encoder not suitable for DSC.	Check whether the drive can be operated with DSC and adjust the drive telegram if required.
TimeOut parameter outside of limits.	Set the monitoring time of the axis control panel to a valid value.
Simulation.Mode parameter outside of limits.	Set the parameter to a valid value.
Telegram in Actor.Interface.AddressIn and AddressOut are not identical.	Set the identical drive telegram type for sending and receiving direction.
Illegal combination for referencing data incremental. encoder.	Check the active and passive homing settings.
Telegram in Sensor[1..4].Interface.AddressIn and AddressOut are not identical.	Set the identical encoder telegram type for sending and receiving direction.
The VREF of the analog output or the bit driver are assigned several times.	Make sure that different addresses are assigned for all technology objects in the project.

Technology alarm 102

Alarm reaction: Remove enable

Restart: Required

Alarm text	Remedy
Drive configuration adaptation error.	
Drive is not assigned to a SINAMICS device.	The drive adaptation is only available for SINAMICS drives.
Drive is not interconnected directly to I/O area.	During configuration of the axis, the logical addresses were set to a data block or bit memory, for example. The adaptation is only possible when the encoder has been directly interconnected to an I/O area.
Adaptation canceled due to insufficient resources.	Check whether your device supports acyclic data communication according to PROFIdrive.
Parameter does not exist, value unreadable or invalid.	
Maximum speed	
Maximum torque/force (P1520)	
Maximum torque/force (P1521)	
Torque resolution	
Rated speed	
Rated torque	
Motor type	

Technology alarm 103

Alarm reaction: Remove enable

Restart: Required

Alarm text	Remedy
Encoder configuration adaptation error.	
Encoder is not assigned to a SINAMICS device.	The encoder adaptation is only available for SINAMICS devices and external Siemens encoders.
Encoder is not interconnected directly to I/O area.	During configuration of the axis, the logical addresses were set to a data block or bit memory address area, for example. The adaptation is only possible when the encoder has been directly interconnected to an I/O area.
Adaptation canceled due to insufficient resources.	Check whether your device supports acyclic data communication according to PROFIdrive.
Parameter does not exist, value unreadable or invalid.	
Encoder system	
Encoder resolution	
Encoder fine resolution Gx_XIST1	
Encoder fine resolution Gx_XIST2	
Encoder revolutions	

Technology alarm 104

Alarm reaction: Stop with maximum dynamic values

Restart: Not required

Alarm text	Remedy
SW limit switch specification error.	
Neg. SW limit switch greater than pos. SW limit switch.	Change the position of the software limit switches.

Technology alarm 105

Alarm reaction: Remove enable

Restart: Required

Alarm text	Remedy
Drive configuration error.	
HW Configuration. The TO needs a smaller servo cycle clock.	<ul style="list-style-type: none"> • Connect a suitable device. • Check the device (I/Os). • Check the topology of the project. • Compare the device configuration and the configuration of the technology object. • Contact customer service.
Error in internal communication.	<ul style="list-style-type: none"> • Check the project for consistency and reload the project into the controller. • Contact customer service.
Address for drive data does not exist in project.	Check the project for consistency and reload the project into the controller.
Error during the parameter assignment of the frame for the torque data.	Check the interconnection of the SIEMENS additional telegram 750 (torque data).
Address overlay during sensor interconnection.	Make sure that different addresses are assigned for all technology objects in the project.

Technology alarm 106

Alarm reaction: Remove enable

Restart: Not required

Alarm text	Remedy
Drive connection configuration error.	
System has no communication with drive.	Internal system error. <ul style="list-style-type: none"> • Check the project for consistency and reload the project into the controller. • Contact customer service.
Drive not initialized during ramp-up.	<ul style="list-style-type: none"> • Ensure that the communication between the controller and drive is established. To do this, evaluate the "<TO>.StatusDrive.CommunicationOK" parameter before enabling the axis. • To enable a technology object, the drive initialization must be complete. Trigger the job again later.

Technology alarm 107

Alarm reaction: Remove enable

Restart: Required

Alarm text	Remedy
Encoder configuration error.	
HW Configuration	<ul style="list-style-type: none"> • Connect a suitable device. • Check the device (I/Os). • Check the topology of the project. • Compare the device configuration and the configuration of the technology object. • Contact customer service.
The TO needs a smaller servo cycle clock.	
Error internal communication.	<ul style="list-style-type: none"> • Check the project for consistency and reload the project into the controller. • Contact customer service.
Address overlay during sensor interconnection.	Make sure that different addresses are assigned for all technology objects in the project.

Technology alarm 108

Alarm reaction: Remove enable

Restart: Not required

Alarm text	Remedy
Encoder connection configuration error.	
System without communication to encoder.	Internal system error. <ul style="list-style-type: none"> • Check the project for consistency and reload the project into the controller. • Contact customer service.
Encoder not initialized during ramp-up.	<ul style="list-style-type: none"> • Ensure that the communication between the controller and encoder is established. To do this, evaluate the "<TO>.StatusSensor[1..4].CommunicationOK" parameter before enabling the axis and also check if the status of the encoder actual value is "<TO>.StatusSensor[1..4].State" = VALID (2). • To enable a technology object, the encoder initialization must be complete. Trigger the job again later.
Encoder data address missing in project.	Check the project for consistency and reload the project into the controller.

Technology alarm 109

Alarm reaction: Remove enable

Restart: Required

Alarm text	Remedy
Configuration error.	
Neg. HW limit switch.	<ul style="list-style-type: none"> • Connect a suitable device. • Check the device (I/Os). • Check the topology of the project. • Compare the device configuration and the configuration of the technology object. • Contact customer service.
Pos. HW limit switch	
Reference output cam "Active homing".	
Reference output cam "Passive homing".	
Enable bit for the analog drive interface.	
DriveReady bit of the analog drive interface.	
Measurement sensing input is faulty.	
Output cam output faulty.	

Technology alarm 110

Alarm reaction: No reaction

Restart: Not required

Alarm text	Remedy
Configuration is adjusted internally.	
Actor.DriveParameter.MaxSpeed is limited.	<ul style="list-style-type: none"> Correct the reference value in the drive and in the configuration of the technology object to "<TO>.Actor.MaxSpeed" / 2. With analog drive connection, correct the reference value in the drive and in the configuration of the technology object to "<TO>.Actor.MaxSpeed" / 1.17. The value can be set in the drive, for example, in p2000 = p1082.
PositioningMonitoring.ToleranceTime is limited.	Change the configuration data.
DynamicDefaults.EmergencyDeceleration is limited.	
DriveParameter.ReferenceTorque too small.	

Technology alarm 111

Alarm reaction: No reaction

Restart: Not required

Alarm text	Remedy
TO and drive configuration inconsistent.	
Different telegram.	Match the telegram configuration for the technology object with the telegram configuration in the drive. (P922 in drive)
Incompatible torque resolution.	Adjust the high torque resolution for the drive.
Application cycle of the drive and servo cycle clock are not the same.	Adjust the application cycle of the drive in the device configuration for the PROFIBUS drive.
Application cycle of the drive and processing cycle of the TO are not the same.	
Linear motor configured.	Set round-frame motor (P300) in the drive.

Technology alarm 112

Alarm reaction: No reaction

Restart: Not required

Alarm text	Remedy
TO and encoder configuration inconsistent.	
Different telegram type.	Match the telegram configuration for the technology object with the telegram configuration in the encoder.
Encoder is not an absolute encoder.	Configure the encoder for the technology object as an incremental encoder.
Application cycle of the encoder and servo cycle clock are not the same.	Adjust the application cycle of the encoder in the device configuration for the PROFIBUS encoder.
Application cycle of the encoder and processing cycle of the TO are not the same.	

Technology alarm 113

Alarm reaction: Remove enable

Restart: Required

Alarm text	Remedy
Isochronous mode not possible.	<ul style="list-style-type: none"> The configured output for the cam or cam track technology object or the input for the technology object measuring input cannot be used in isochronous mode. Configure the I/O in the device configuration as isochronous I/O. The maximum permissible bus clock T_{Send} has been exceeded. The maximum bus clock for the use of SINAMICS measuring inputs is up to 8 ms. Make sure that the organization block MC-Servo [OB91] is called synchronously with the bus system.

Technology alarm 114

Alarm reaction: Remove enable

Restart: Required

Alarm text	Remedy
Cross-PLC synchronous operation configuration error.	Check the configuration of the interconnected leading and following axes. Make sure that all relevant tags are correctly configured for cross-PLC synchronous operation.

A.1.3 Technology alarms 201-204 (S7-1500, S7-1500T)

Technology alarm 201

Alarm reaction: Remove enable

Restart: Required

Alarm text	Solution
Internal error.	Contact customer service.

Technology alarm 202

Alarm reaction: No reaction

Restart: Required

Alarm text	Solution
Internal configuration error.	Contact customer service.

Technology alarm 203

Alarm reaction: Remove enable

Restart: Required

Alarm text	Solution
Internal error.	Contact customer service.

Technology alarm 204

Alarm reaction: Remove enable

Restart: Not required

Alarm text	Solution
Commissioning error.	
Connection to the TIA Portal interrupted.	Check the connection properties.

A.1.4 Technology alarms 304-343 (S7-1500, S7-1500T)

Technology alarm 304

Alarm reaction: Stop with emergency stop ramp

Restart: Not required

Alarm text	Remedy
Velocity limit is zero.	Enter a non-zero value for the maximum velocity (DynamicLimits.MaxVelocity) in the dynamic limits.

Technology alarm 305

Alarm reaction: Stop with emergency stop ramp

Restart: Not required

Alarm text	Remedy
Acceleration/deceleration limit is zero.	
Acceleration	Enter a non-zero value for the maximum acceleration (DynamicLimits.MaxAcceleration) in the dynamic limits.
Deceleration	Enter a non-zero value for the maximum deceleration (DynamicLimits.MaxDeceleration) in the dynamic limits.

Technology alarm 306

Alarm reaction: Stop with emergency stop ramp

Restart: Not required

Alarm text	Remedy
Jerk limit is zero.	Enter a non-zero value for the maximum jerk (DynamicLimits.MaxJerk) in the dynamic limits.

Technology alarm 307

Alarm reaction: Stop with maximum dynamic values

Restart: Not required

Alarm text	Remedy
Negative/positive numerical value range of the position reached.	
Negative	Enable the "Modulo" setting for the technology object.
Positive	

Technology alarm 308

Alarm reaction: Remove enable

Restart: Not required

Alarm text	Remedy
Negative/positive numerical value range of the position exceeded.	
Negative	Enable the "Modulo" setting for the technology object.
Positive	

Technology alarm 321

Alarm reaction: Stop with emergency stop ramp

Restart: Not required

Alarm text	Remedy
Axis not homed.	To perform an absolute positioning motion, you must home the technology object.

Technology alarm 322

Alarm reaction: No reaction

Restart: Not required

Alarm text	Remedy
Restart not executed.	
The technology object is not ready for restart.	Download the project again.
The condition for restart of the technology object is not satisfied.	Disable the technology object.

Technology alarm 323

Alarm reaction: Remove enable

Restart: Not required

Alarm text	Remedy
MC_Home could not be performed.	<ul style="list-style-type: none"> • Enable the "Modulo" setting for the technology object. • Adjust the position value for use of the Motion Control instruction "MC_Home".

Technology alarm 341

Alarm reaction: Stop with maximum dynamic values

Restart: Not required

Alarm text	Remedy
Error in homing data.	
Approach velocity is zero.	Check the configuration for homing (Homing.ApproachVelocity).
Homing velocity is zero.	Check the configuration for homing (Homing.ReferencingVelocity).

Technology alarm 342

Alarm reaction: Stop with emergency stop ramp

Restart: Not required

Alarm text	Remedy
Reference cam/encoder zero mark not found.	The reference cam configured for homing was not found in the traversing range of the axis.

Technology alarm 343

Alarm reaction: Remove enable

Restart: Not required

Alarm text	Remedy
Homing function not supported by device.	Configure a reference switch input for the pulse generator output used in the properties of the C-CPU. ("Pulse generators (PTO/PWM) > PTO[n]/PWN[n] > Hardware inputs/outputs") When homing across a zero mark, the CPU transfers the reference switch input as zero mark.

A.1.5 Technology alarms 401-431 (S7-1500, S7-1500T)

Technology alarm 401

Alarm reaction: Remove enable

Restart: Not required

Alarm text	Solution
Error accessing logical address.	
Invalid address.	<ul style="list-style-type: none"> • Connect a suitable device. • Check the device (I/Os). • Check the topology of the project. • Compare the device configuration and the configuration of the technology object. • Configure the valid hardware limit switch. • Contact customer service.
Input address is invalid.	
Output address is invalid.	
Error during parameter assignment of the technology block driver.	<p>Make sure that different addresses are assigned for all technology objects in the project.</p>
Address overlay during sensor interconnection.	
Address overlay during sensor interconnection.	

Technology alarm 411

Alarm reaction: Remove enable

Restart: Not required

Alarm text	Solution
Faulty encoder at the logical address.	
Alarm message from encoder.	Check the function, connections and I/Os of the encoder.
HW error encoder.	
Encoder dirty.	
Read error encoder absolute value.	Compare the encoder type in the drive or encoder parameter P979 with the configuration data of the technology object.
Zero mark monitoring encoder.	Encoder signals error in zero mark monitoring (fault code 0x0002 in Gx_XIST2, see PROFIdrive profile).
Encoder in Parking state.	<ul style="list-style-type: none"> Search for the cause of the error in the connected drive or encoder. Check whether the alarm was possibly triggered by a commissioning action involving the drive or encoder.
Encoder not ready after "MC_Reset".	<p>Before sending the Motion Control instruction "MC_Power", check whether the encoder is ready during switch on.</p> <p>Check the following tags of the corresponding technology object:</p> <ul style="list-style-type: none"> <TO>.StatusDrive.CommunicationOK <TO>.StatusSensor[1..4].CommunicationOK <TO>.StatusSensor[1..4].State

Technology alarm 412

Alarm reaction: Remove enable

Restart: Not required

Alarm text	Remedy
Permitted actual value range exceeded.	
Positive.	Home the axis/encoder in a valid actual value range.
Negative.	
Modulo length.	Adjust the modulo length to the utilized encoder.

Technology alarm 421

Alarm reaction: Remove enable

Restart: Not required

Alarm text	Solution
Faulty encoder at the logical address.	
Alarm message from drive.	<ul style="list-style-type: none"> • Check the functions and connections of the drive. • Enable and acknowledge safety function in the drive. You can find more information in the section "Safety functions in the drive" of the documentation "S7-1500/S7-1500T Axis functions (https://support.industry.siemens.com/cs/ww/en/view/109766462)". • In the case of analog connected axes, check if the "<TO>.StatusDrive.InOperation" tag = TRUE.
No drive control required.	
Drive has shut down.	
Drive enable not possible.	

Technology alarm 431

Alarm reaction: Remove enable

Restart: Not required

Alarm text	Solution
Faulty communication with device at logical address.	
Drive failed.	Check the function, connections and I/Os of the drive.
Signs of life of drive faulty.	<ul style="list-style-type: none"> • Check the function, connections and I/Os of the drive. • Compare the clock parameters in the device configuration (PROFIBUS line, slave OM for drive or encoder) and the execution system. Tmapc and servo must be set to the same cycle time. (Incorrect parameter assignment is indicated by reason 0x0080.) • If you call the application cycle of the MC-Servo [OB91] reduced to the send clock of a PROFINET IO system and the technology alarm 431 (Signs of life of drive faulty) is repeatedly shown, increase the update time of the send clock.
Encoder failed.	Check the function, connections and I/Os of the encoder.
Signs of life of encoder faulty.	<ul style="list-style-type: none"> • Check the function, connections and I/Os of the encoder. • Compare the clock parameters in the device configuration (PROFIBUS line, slave OM for drive or encoder) and the execution system. Tmapc and servo must be set to the same cycle time.

A.1.6 Technology alarms 501-552 (S7-1500, S7-1500T)

Technology alarm 501

Alarm reaction: No reaction

Restart: Not required

Alarm text	Remedy
Programmed velocity is limited.	<ul style="list-style-type: none"> • Check the value for the velocity of the Motion Control instruction. • Check the configuration of the dynamic limits.

Technology alarm 502

Alarm reaction: No reaction

Restart: Not required

Alarm text	Remedy
Programmed acceleration/deceleration is being limited.	
Acceleration	<ul style="list-style-type: none"> • Check the value for the acceleration of the Motion Control instruction. • Check the configuration of the dynamic limits.
Deceleration	<ul style="list-style-type: none"> • Check the value for the deceleration of the Motion Control instruction. • Check the configuration of the dynamic limits.

Technology alarm 503

Alarm reaction: No reaction

Restart: Not required

Alarm text	Remedy
Programmed jerk is limited.	<ul style="list-style-type: none"> • Check the value for the jerk of the Motion Control instruction. • Check the configuration of the dynamic limits.

Technology alarm 504

Alarm reaction: No reaction

Restart: Not required

Alarm text	Remedy
Speed setpoint monitoring active.	<ul style="list-style-type: none"> • Check the mechanical configuration. • Check the encoder connection. • Check the configuration of the speed setpoint interface. • Check the configuration of the control loop. • Check the value for the maximum velocity (<TO>.DynamicLimits.MaxVelocity).

Technology alarm 511

Alarm reaction: No reaction

Restart: Not required

Alarm text	Remedy
Dynamic limits are violated by the kinematics motion.	
Velocity	Reduce the velocity of the kinematics motion.
Acceleration	Reduce the acceleration of the kinematics motion.
Deceleration	Reduce the deceleration of the kinematics motion.

Technology alarm 521

Alarm reaction: Remove enable

Restart: Not required

Alarm text	Remedy
Following error.	<ul style="list-style-type: none"> • Check the configuration of the control loop. • Check the direction signal of the encoder. • Check the configuration of the following error monitoring.

Technology alarm 522

Alarm reaction: No reaction

Restart: Not required

Alarm text	Remedy
Warning following error tolerance.	<ul style="list-style-type: none"> • Check the configuration of the control loop. • Check the direction signal of the encoder. • Check the configuration of the following error monitoring.

Technology alarm 531

Alarm reaction: Remove enable

Restart: Not required

Alarm text	Remedy
Pos. HW limit switch reached.	Acknowledge the alarm. After the acknowledgment, motions in the negative direction are allowed.
Neg. HW limit switch reached.	Acknowledge the alarm. After the acknowledgment, motions in the positive direction are allowed.
Illegal free travel direction of active hardware limit switch.	The programmed direction of movement is disabled due to the active hardware limit switch. Retract the axis in the opposite direction.

Alarm reaction: Remove enable

Restart: Required

Alarm text	Remedy
HW limit switch polarity reversed, free travel not possible. Both hardware limit switches active, retraction not possible.	<ul style="list-style-type: none"> • Check the mechanical configuration of the hardware limit switch. • Check the limit switches. • The error can be acknowledged by switching the controller off and on or using "MC_Reset" with "Restart" = TRUE.

Technology alarm 533

Alarm reaction: Stop with maximum dynamic values

Restart: Not required

Alarm text	Remedy
Software limit switch is approached.	
Negative	<p>With the current dynamic values, the axis will approach the negative software limit switch.</p> <p>For positioning axes, check the position setpoint.</p> <p>For following axes, check whether the current dynamics violates the configured dynamic limits.</p> <p>Move the axis in positive direction away from the negative software limit switch.</p>
Positive	<p>With the current dynamic values, the axis will approach the positive software limit switch.</p> <p>For positioning axes, check the position setpoint.</p> <p>For following axes, check whether the current dynamics violates the configured dynamic limits.</p> <p>Move the axis in negative direction away from the positive software limit switch</p>

Technology alarm 534

Alarm reaction: Remove enable

Restart: Not required

Alarm text	Remedy
Software limit switch was overshoot.	
Negative	<p>The software limit switch was overtraveled.</p> <p>Acknowledge the alarm.</p> <p>After the acknowledgment, motions in the positive direction are allowed.</p>
Positive	<p>The software limit switch was overtraveled.</p> <p>Acknowledge the alarm.</p> <p>After the acknowledgment, motions in the negative direction are allowed.</p>

Technology alarm 541

Alarm reaction: Remove enable

Restart: Not required

Alarm text	Remedy
Position monitoring error.	
Target range not reached.	The target range was not reached within the tolerance time. <ul style="list-style-type: none"> • Check the configuration of the position monitoring. • Check the configuration of the control loop.
Exit target range again.	The target range was exited within the minimum dwell time. <ul style="list-style-type: none"> • Check the configuration of the position monitoring. • Check the configuration of the control loop.

Technology alarm 542

Alarm reaction: Remove enable

Restart: Not required

Alarm text	Remedy
Clamping monitoring error: Axis leaving clamping tolerance window.	The axis has executed a motion greater than the permissible tolerance at the fixed stop. Check whether the fixed stop has broken away.

Technology alarm 550

Alarm reaction: Track setpoints

Restart: Not required

Alarm text	Remedy
Drive-autonomous motion is being executed.	The drive is performing a motion that was not specified by the technology object. Check if a safety function is active in the drive. You can find more information in the section "Safety functions in the drive" of the documentation "S7-1500/S7-1500T Axis functions (https://support.industry.siemens.com/cs/ww/en/view/109766459)".

Technology alarm 551

Alarm reaction: No reaction

Restart: Not required

Alarm text	Remedy
Maximum velocity cannot be reached with drive/axis parameters.	The configured maximum velocity cannot be reached with the configured mechanics of the axis. Check the configuration of the mechanics and the set reference speed.

Technology alarm 552

Alarm reaction: Remove enable

Restart: Not required

Alarm text	Remedy
Encoder adaptation error during ramp-up.	
Encoder is not assigned to a SINAMICS device.	<ul style="list-style-type: none"> The operationally active encoder could not be adapted. Other encoders that can be used are configured. Use the encoder switch (MC_SetSensor). The encoder set as the operationally active encoder could not be adapted. Specify a different sensor for the initialization of the technology object.
Encoder is not interconnected directly to I/O area.	During configuration of the axis, the logical addresses were set to a data block or bit memory address area, for example. The adaptation is only possible when the encoder has been directly interconnected to an I/O area.
Adaptation canceled due to insufficient resources.	Check whether your device supports acyclic data communication according to PROFIdrive.
Parameter does not exist, value unreadable or invalid.	
Encoder system	
Encoder resolution	
Encoder fine resolution	
Encoder revolutions	

A.1.7 Technology alarms 601-613 (S7-1500, S7-1500T)

Technology alarm 601

Alarm reaction: Stop with maximum dynamic values

Restart: Not required

Alarm text	Solution
Leading axis is not assigned or defective.	Configure the possible leading value axes for the following axis under "Configuration > Leading value interconnections". For a cross-PLC synchronous operation make sure that the option "Synchronous to the bus" is selected for the MC-SERVO OBs of all connected CPUs under "Properties > General > Cycle time".

Technology alarm 603

Alarm reaction: No reaction

Restart: Not required

Alarm text	Solution
Leading axis is not in position-controlled mode.	The following axis must be operated in position-controlled mode for synchronous operation functionality.

Technology alarm 608

Alarm reaction: Stop with maximum dynamic values

Restart: Not required

Alarm text	Solution
Error during synchronization.	Prevent a reversing leading value motion during the synchronization operation.

Technology alarm 611

Alarm reaction: Remove enable

Restart: Not required

Alarm text	Solution
The cam specified in the MC_CamIn.Cam parameter has not been configured or is not available.	Configure and interpolate the cam. Restart the job.

Technology alarm 612

Alarm reaction: Remove enable

Restart: Not required

Alarm text	Solution
Specified cam has not been interpolated.	Interpolate the cam used for camming with the Motion Control instruction "MC_InterpolateCam".

Technology alarm 613

Alarm reaction: Remove enable

Restart: Not required

Alarm text	Remedy
Accuracy of leading value is limited.	Decrease the configured delay time.

A.1.8 Technology alarms 700-758 (S7-1500, S7-1500T)

Technology alarm 700

Alarm reaction: Remove enable

Restart: Not required

Alarm text	Remedy
Output cam limiting error.	
Cam position: OnPosition	The position for the "OnPosition" parameter could not be calculated. Invalid positions (e.g. "OnPosition" > "OffPosition") were calculated due to lead times. The output cam cannot be switched due to the axis dynamics and compensation times.
Cam position: OffPosition	The position for the "OffPosition" parameter could not be calculated. Invalid positions (e.g. "OffPosition" > "OnPosition") were calculated due to lead times. The output cam cannot be switched due to the axis dynamics and compensation times.

Technology alarm 701

Alarm reaction: Remove enable

Restart: Not required

Alarm text	Remedy
I/O output error.	The digital output for the output cam or cam track technology object cannot be addressed. Download the device configuration again.

Technology alarm 702

Alarm reaction: Remove enable

Restart: Not required

Alarm text	Remedy
Position value invalid.	<ul style="list-style-type: none"> A Motion Control job "MC_Reset" is being executed on the axis. Wait until the technology object restart is complete. The encoder values are invalid due to an encoder error. Check the encoder and adjust the configuration if necessary.

Technology alarm 703

Alarm reaction: Remove enable

Restart: Not required

Alarm text	Remedy
Output cam data faulty.	
Output cam: Output cam number	<p>Check the configuration of the relevant output cam in the cam track and adjust the values if necessary.</p> <p>Examples of a correct configuration:</p> <ul style="list-style-type: none"> "<TO>.Parameter.Cam[1..32].OnPosition" < "<TO>.Parameter.Cam[1..32].OffPosition" "<TO>.Parameter.Cam[1..32].Duration" > "<TO>.Parameter.OffCompensation" - "<TO>.Parameter.OnCompensation"

Technology alarm 704

Alarm reaction: Remove enable

Restart: Not required

Alarm text	Remedy
Output cam data faulty.	
	<p>Check the configuration of the output cam and adjust the values if necessary.</p> <p>Examples of a correct configuration:</p> <ul style="list-style-type: none"> "MC_OutputCam.OnPosition" < "MC_OutputCam.OffPosition" "MC_OutputCam.Duration" > "<TO>.Parameter.OffCompensation" - "<TO>.Parameter.OnCompensation"

Technology alarm 750

Alarm reaction: Remove enable

Restart: Not required

Alarm text	Remedy
Measuring job not possible during homing of assigned axis.	Do not use the motion instructions "MC_Home" and "MC_MeasuringInput" simultaneously.

Technology alarm 752

Alarm reaction: No reaction

Restart: Not required

Alarm text	Remedy
Validity range of measuring job not recognized.	The measuring range specified in Motion Control instruction "MC_MeasuringInput" was not recognized. Adjust the measuring range.

Technology alarm 753

Alarm reaction: Remove enable

Restart: Not required

Alarm text	Remedy
Only one measuring input can access an encoder at a time.	Use only one Motion Control instruction "MC_MeasurinInput" for an encoder.

Technology alarm 754

Alarm reaction: Remove enable

Restart: Not required

Alarm text	Remedy
Measuring input configuration in external device is not correct.	Check the configuration of the measuring inputs on the external device.

Technology alarm 755

Alarm reaction: Remove enable

Restart: Not required

Alarm text	Remedy
Measuring job not possible.	
Device has reported an error.	The measurement was aborted with error. Check the measuring input functionality in the utilized device
Cyclic measuring is not possible with telegram 39x.	<ul style="list-style-type: none"> • Use the Motion Control instruction "MC_MeasuringInput" for starting a one-time measurement. • Cyclic measuring is only possible when measuring using TM Timer DIDQ. Change the configuration of the measuring input type to "TM Timer DIDQ".

Technology alarm 758

Alarm reaction: None

Restart: Not required

Alarm text	Remedy
A measuring edge was not evaluated.	An edge was already detected at the input of the measuring input even though the module was not yet ready. The measured value is provided at the next edge.

A.1.9 Technology alarms 900-902 (S7-1500, S7-1500T)

Technology alarm 900

Alarm reaction: Remove enable

Restart: Required

Alarm text	Solution
Invalid leading values	<p>Check whether the set tolerance time at the parameter "<TO>.Parameter.ToleranceTimeExternalLeadingValueInvalid" was exceeded.</p> <p>Check the connection of the interconnected components. Make sure that there is no communication interference.</p>

Technology alarm 901

Alarm reaction: Remove enable

Restart: Not required

Alarm text	Solution
Data transmission error	
Invalid version	Use a leading value telegram with a valid version.
Invalid modulo start value	Scale the modulo start value of the external leading value at the parameter "<TO>.StatusExternalLeadingValue.ModuloStartValue".
Invalid modulo length	Scale the modulo length of the external leading value at the parameter "<TO>.StatusExternalLeadingValue.ModuloLength".
Sign-of-life error	Check the communication.
Invalid position	Check the leading value of the leading axis on the other CPU.
Invalid velocity	
Invalid acceleration	

Technology alarm 902

Alarm reaction: Remove enable

Restart: Not required

Alarm text	Remedy
Accuracy of leading value is limited.	Decrease the configured delay time.

A.2 Error ID for Motion Control instructions (S7-1500, S7-1500T)

Errors in Motion Control instructions are signaled using the parameters "Error" and "ErrorID".

Under the following conditions, "Error" = TRUE and "ErrorID" = 16#8xxx are indicated for the Motion Control instruction:

- Illegal status of the technology object, which prevents the execution of the job.
- Illegal parameter assignment of the Motion Control instruction, which prevents the execution of the job.
- As a result of the alarm reaction for a technology object error.

The following tables list all "ErrorIDs" that can be indicated for Motion Control instructions. In addition to the cause of the error, solutions for eliminating the error are also listed:

16#0000 - 16#800F

ErrorID	Description	Remedy
16#0000	No error	-
16#8001	A technology alarm (technology object error) occurred while processing the Motion Control instruction.	In the technology data block, an error message is output at the "ErrorDetail.Number" tag. You can find a list of the technology alarms and alarm reactions in the "Technology alarms (Page 140)" appendix.
16#8002	Illegal specification of the technology object	<ul style="list-style-type: none"> • Check the specification of the technology object for the "Axis", "Master", "SlaveOutputCamCamTrackMeasuringInput" or "Cam" parameter. • You can use a kinematics technology object only for the "AxesGroup" parameter. • With "MC_MeasuringInputCyclic": Specify a valid measuring input type for parameter "MeasuringInputType".
16#8003	Illegal velocity specification	Specify a permissible value for the velocity for parameter "Velocity".
16#8004	Illegal acceleration specification	Specify a permissible value for the acceleration for parameter "Acceleration".
16#8005	Illegal deceleration specification	Specify a permissible value for the deceleration for parameter "Deceleration".
16#8006	Illegal jerk specification	Specify a permissible value for the jerk for parameter "Jerk".
16#8007	Illegal direction specification	Specify a permissible value for the rotation direction for parameter "Direction" or "SyncDirection".
	Invalid entry Both the "JogForward" and "JogBackward" parameters are set to TRUE at the same time. The axis is braked at the last valid deceleration.	Reset both the "JogForward" parameter and the "JogBackward" parameter.
16#8008	Invalid distance specification	Set a valid distance value at parameter "Distance".
16#8009	Invalid position specification	Set a valid position value at parameter "Position".

A.2 Error ID for Motion Control instructions (S7-1500, S7-1500T)

ErrorID	Description	Remedy
16#800A	Illegal operating mode	Specify a permissible operating mode for parameter "Mode".
16#800B	Illegal stop mode specifications	Specify a permissible value for the stop mode at the "StopMode" parameter.
16#800C	Only one instance of the instruction per technology object is allowed.	<ul style="list-style-type: none"> The instruction is called at multiple points in the user program with identical value for parameter "Axis", "Master", "Slave" or "Cam". Ensure that only one instruction with the value for parameter "Axis", "Master", "Slave" or "Cam" is called. The error message can occur through the DB editor functions "Load snapshot as actual values" or "Load start values as actual values". Correct the error of the affected technology data block by switching the CPU to STOP, re-compiling the affected DB, and loading it into the device. You can find additional information in the section "Diagnostics (Page 133)".
16#800D	The job is not permitted in the current state. "Restart" is executed.	While a "Restart" is being performed, the technology object cannot perform any jobs. Wait until the "Restart" of the technology object is complete.
16#800E	If the technology object is enabled, a "Restart" is not possible.	Before a "Restart", deactivate the technology object with "MC_Power.Enable"FALSE.
16#800F	The job cannot be executed because the technology object is locked.	<ul style="list-style-type: none"> Enable the technology object with "MC_Power.Enable" = TRUE. Restart the job. A "MC_Stop" job is active with "Execute" = TRUE. Reset the job with the parameter "Execute" = FALSE.

16#8010 - 16#802F

ErrorID	Description	Remedy
16#8010	Invalid homing mode for incremental encoder	Absolute value adjustment is not possible with an incremental encoder ("Mode" = 6, 7). Start a homing process for an incremental encoder using parameter "Mode" = 0, 1, 2, 3, 5, 8, 10, 11, 12.
16#8011	Invalid homing mode for absolute encoder	Passive and active homing ("Mode" = 2, 3, 5, 8, 10) are not possible for an absolute value encoder. Start a homing process for an absolute encoder using parameter "Mode" = 0, 1, 6, 7, 11, 12.
16#8012	The job cannot be executed because the axis control panel is active.	Return master control to your user program. Restart the job.
16#8013	The online connection between the CPU and the TIA Portal is down.	Check the online connection to the CPU.
16#8014	No internal job memory available.	The maximum possible number of Motion Control job has been reached. Reduce the number of jobs to be executed (parameter "Execute" = FALSE).

A.2 Error ID for Motion Control instructions (S7-1500, S7-1500T)

ErrorID	Description	Remedy
16#8015	Error acknowledgment with "MC_Reset" is not possible. Error in the configuration of the technology object.	Check the configuration of the technology object.
16#8016	The actual values are not valid.	To execute a "MC_Home" or positioning job, the actual values must be valid. Check the status of the actual values. The "<TO>.StatusSensor[1..4].State" tag of the technology object must show the value 2 (valid).
16#8017	Illegal value for gear ratio numerator	Specify a permissible value for the gear ratio numerator for parameter "RatioNumerator". Permitted integer values: -2147483648 to 2147483647 (value 0 not permitted)
16#8018	Illegal value for gear ratio denominator	Specify a permissible value for the gear ratio denominator for parameter "RatioDenominator". Permitted integer values: 1 to 2147483647
16#8019	Job cannot be executed. The specified following axis is the original leading value for the synchronous operation chain.	Recursive interconnections are not possible. A leading axis cannot be interconnected as a following axis to its own leading value. Specify a permissible following axis for parameter "Slave".
16#8021	Illegal value for shift of the leading value range	Specify a permissible value for the shift of the leading value range for parameter "MasterOffset".
16#8022	Illegal value for shift of the following value range	Specify a permissible value for the shift of the leading value range for parameter "SlaveOffset".
16#8023	Illegal value for scaling of the leading value range	Specify a permissible value for the scaling of the leading value range for parameter "MasterScaling".
16#8024	Illegal value for scaling of the following value range	Specify a permissible value for the scaling of the following value range for parameter "SlaveScaling".
16#8026	Illegal value for leading value distance	Specify a permissible value for the leading value distance for parameter "MasterStartDistance".
16#8027	Illegal value for use of cam	Specify a permissible value for cyclic/acyclic use of the cam for parameter "ApplicationMode".

16#8030 - 16#807F

ErrorID	Description	Remedy
16#8034	Illegal value for synchronous position of the leading axis	Specify a permissible value for the synchronous position of the leading axis for parameter "MasterSyncPosition".
16#8035	Illegal value for synchronous position of the following axis	Specify a permissible value for the synchronous position of the following axis for parameter "SlaveSyncPosition".
16#8036	Illegal value for type of synchronization	Specify a permissible value for the type of synchronization for parameter "SyncProfileReference".
16#8040	Illegal value for start position of output cam	Specify a permissible value for the start position of the output cam for parameter "OnPosition".
16#8041	Illegal value for end position of distance output cam	Specify a permissible value for the end position of the distance output cam for parameter "OffPosition".
16#8042	Illegal value for switch-on duration of time-based output cam	Specify a permissible value for the switch-on duration of the time-based output cam for parameter "Duration".
16#8043	Illegal value for force/torque limiting	Specify a value within the permissible range at the "Limit" parameter. Permitted integer values: -2147483648 to 2147483648
16#8044	The axis is not configured for torque reduction.	Select drive telegram 102, 103, 105 or 106
16#8045	The job cannot be executed because a job for traveling to fixed stop is active.	Switchover to non-position-controlled mode is not possible during active travel to fixed stop.
16#8046	The "MC_TorqueLimiting" job cannot be deactivated in the "InClamping" state.	Retract the axis and deactivate "MC_TorqueLimiting".
16#8047	The motion results in a fixed stop.	Only motions away from the fixed stop are permitted.
16#804A	Illegal value for additive torque setpoint	Specify a permissible value for the additive torque setpoint at the "Value" parameter.
16#804B	Illegal value for torque high limit	Specify a permissible value for the high limit of the torque at the "UpperLimit" parameter.
16#804C	Illegal value for torque low limit	Specify a permissible value for the low limit of the torque at the "LowerLimit" parameter.
16#804D	The value of the high limit of the torque is less than or equal to the value of the low limit of the torque.	Adapt the values of the "UpperLimit" and "LowerLimit" parameters so that the high limit of the torque is greater than the value of the low limit of the torque.
16#804E	The job cannot be executed because a "MC_TorqueLimiting" job is active.	Stop the force/torque limit or fixed stop detection. Restart the "MC_TorqueRange" job.
	The job cannot be executed because a "MC_TorqueRange" job is active.	Exit the setting of the high and low torque limits. Restart the "MC_TorqueLimiting" job.
16#804F	The axis is not configured for additional torque values.	Use supplemental telegram 750.
16#8050	Illegal encoder number	Specify a permissible number of the new encoder (1 to 4) for parameter "MC_SetSensor.Sensor".
16#8051	Illegal number of the reference encoder	Specify a permissible number of the reference encoder for parameter "MC_SetSensor.ReferenceSensor".
16#8055	Bit masking not permitted at "MC_SetAxisSTW"	Non-controllable bits are selected in the "STW1 BitMask" and "STW2 BitMask" bit masks. Only control permissible bits.

A.2 Error ID for Motion Control instructions (S7-1500, S7-1500T)

ErrorID	Description	Remedy
16#805A	Illegal value of the parameter to be changed	At parameter "ParameterNumber", enter a permissible value for the index of the parameter to be changed.
16#805B	Error in the configuration of the hardware limit switch.	Specify a valid tag at the input of the positive/negative hardware limit switch.
16#805C	Illegal data type of the value to be written.	Specify a valid data type at the parameter "Value".
16#8062	Illegal approach value	Specify a permissible approach value for the searched for leading value for parameter "ApproachLeadingValue".
16#8063	A valid mapping to the definition range (leading values) does not exist for the specified following value.	Specify a permissible following value for parameter "FollowingValue".
16#8064	A valid mapping to the range of the function (following values) does not exist for the specified leading value.	Specify a permissible leading value for parameter "LeadingValue".
16#8070	Illegal value for leading value shift	Specify a permissible value for the leading value shift for parameter "PhaseShift".
16#8071	The job cannot be executed because the axis is not in position-controlled mode.	Activate position-controlled mode.
16#8074	The job cannot be executed because a "MC_Home" job is active.	During active or passive homing, an encoder switchover is rejected. Wait until the "MC_Home" job is complete. Restart the job.
16#8075	The job cannot be executed because no synchronization operation is active on the axis.	Switch on the synchronous operation function. Restart the job.
16#8076	The job cannot be executed because synchronization is being simulated at the specified axis.	End the simulation of the synchronous operation. Restart the job.

16#80A0 - 16#8FFF

ErrorID	Description	Remedy
16#80A1	The order cannot be executed because a synchronous operation job is active.	A "MC_Home" job on a following axis is not executed when a "MC_CamIn" or "MC_GearInPos" job is active. Exit the synchronous operation job. Restart the job.
16#80A2	<ul style="list-style-type: none"> For one-time measuring with measuring range, the measuring range was run without a measuring edge being detected. The measuring range is invalid with the configured modulo axis settings. 	Check and adjust the measuring input and adjust the measuring range positions, if necessary.
16#80A3	The measuring input job via PROFIdrive telegram could not be started because a homing job is active.	Simultaneous execution of a homing job and a measuring input job via PROFIdrive telegram is not possible. Wait until the homing job has ended. Restart the measuring job via PROFIdrive telegram.
16#80A5	Illegal value for start position of measuring range	Specify a permissible value for the start position of the measuring range for parameter "MC_MeasuringInput.StartPosition" or "MC_MeasuringInputCyclic.StartPosition".

ErrorID	Description	Remedy
16#80A6	Illegal value for end position of measuring range	Specify a permissible value for the end position of the measuring range for parameter "MC_MeasuringInput.EndPosition" or MC_MeasuringInputCyclic.EndPosition.
16#80A7	A measurement is performed when measuring with the measuring range, but the calculated position is outside the specified measuring range. The measured value is discarded.	Check and adjust the measuring input and adjust the measuring range positions, if necessary.
16#80A8	The job cannot be executed because camming is active on the axis.	The Motion Control instructions "MC_PhasingRelative" and "MC_PhasingAbsolute" can only be applied to active gearing with "MC_GearIn" or "MC_GearInPos" ("MC_GearIn.InGear" = TRUE or "MC_GearInPos.InSync" = TRUE).
16#80A9	The job cannot be executed because the following axis is synchronized ("MC_GearInPos.StartSync" = TRUE) or a kinematics motion is active.	The Motion Control instructions "MC_PhasingRelative" and "MC_PhasingAbsolute" can only be applied to active gearing with "MC_GearIn" or "MC_GearInPos" ("MC_GearIn.InGear" = TRUE or "MC_GearInPos.InSync" = TRUE).
16#80AA	The cam contains no points or segments and cannot be interpolated.	Fill the cam with points/segments. Restart the job.
16#80AB	The cam is currently being used and cannot be interpolated.	End the current use of the cam. Restart the job.
16#80AC	The cam contains incorrect points or segments and cannot be interpolated. (for example, the cam contains only one point.)	Fill the cam with permissible points/segments. Restart the job.
16#80AD	The specified synchronous position is outside the definition range of the cam.	Specify a permissible synchronous position for parameter "MasterSyncPosition". Restart the job.
16#80AE	The job cannot be executed because a kinematic motion is active.	End the current kinematic motion. Restart the job.
16#8FFF	Unspecified error	Contact your local Siemens representative or support center. You will find your contact information for digital industries at: https://www.siemens.com/automation/partner (https://www.siemens.com/automation/partner)

See also

Errors in Motion Control instructions (Page 139)

A.3 SINAMICS drives (S7-1500, S7-1500T)

A.3.1 Compatibility list (S7-1500, S7-1500T)

An overview of drives that can be interconnected with an S7-1500 CPU is available at:

<https://support.industry.siemens.com/cs/document/109750431>
(<https://support.industry.siemens.com/cs/ww/en/view/109750431>)

A.3.2 Homing SINAMICS drives with external zero marks (S7-1500, S7-1500T)

For SINAMICS drives with external zero mark, synchronization during homing must always occur on the left side of the external zero mark's signal. That is to say, with a positive direction of travel synchronization is done on a positive edge, and with a negative direction of travel synchronization is done on a negative edge.

By inverting the signal, synchronization can also be done on the right side of the signal of the external zero mark. The inversion can be configured in the drive using SINAMICS parameter P490.

Homing to an encoder zero mark or an external zero mark is configured in SINAMICS parameter P495.

A.4 Data types (S7-1500, S7-1500T)

Data types for the use of technology

The table below contains the data types for reference to the respective technology object:

Data type	Description
TO_Object ¹⁾	Base
TO_SpeedAxis ¹⁾	Speed axis
TO_PositioningAxis ¹⁾	Positioning axis
TO_SynchronousAxis ¹⁾	Synchronous axis
TO_Encoder ¹⁾	External encoder
TO_OutputCam	Output cam
TO_CamTrack	Cam track
TO_MeasuringInput	Measuring input
TO_Cam	Cam (S7-1500T)
TO_Kinematics	Kinematics (S7-1500T)
TO_LeadingAxisProxy ¹⁾	Leading axis proxy (S7-1500T)
PD_TELx	Telegram no. "x"
DX_TEL_SyncOp	Leading value telegram (S7-1500T)
PD_STW1_611Umode	Control word 1 (STW1)
PD_STW2_611Umode	Control word 2 (STW2)
PD_ZSW1_611Umode	Status word 1 (ZSW1)
PD_ZSW2_611Umode	Status word 2 (ZSW2)

¹⁾ Cascading technology objects

Cascading technology objects

The structure of the technology objects is structured as follows:

- "TO_Object" is the basis of all technology objects and a component of the "TO_Axis".
- "TO_Axis" is part of "TO_SpeedAxis", "TO_Encoder" and "TO_LeadingAxisProxy".
- "TO_SpeedAxis" is part of "TO_PositioningAxis".
- "TO_PositioningAxis" is part of "TO_SynchronousAxis".

Glossary (S7-1500, S7-1500T)

Absolute synchronous operation

Function corresponds to the Motion Control instruction MC_GearInPos or MC_CamIn.

Absolute value encoder

Position encoder which outputs the position in the form of a digital numerical value. This numerical value is unique within the entire measuring range of the absolute value encoder.

Axis control panel

The axis control panel allows you to move the axis in manual mode, optimize the axis settings, and test the operation of the axis in your system.

Axis type

The axis type differs depending on the unit of measurement according to which the axis is positioned.

Depending on the execution of the mechanics, an axis is implemented as a linear axis or rotary axis:

- For linear axes, the position of the axis is specified as a linear measure, e.g. millimeters (mm).
- For rotary axes, the position of the axis is specified as an angular measure, e.g. degrees (°).

Communication processor (CP)

Module for expanded communications tasks covering special applications, for example in the area of security.

Communications module (CM)

Module for communications tasks which is used as an interface expansion of the CPU (for example PROFIBUS) or provides additional communications options (e.g. PtP) in an automation system.

Drive

The combination of motor (electric or hydraulic), actuator (converter, valve), control system, measuring system and supply (infeed, accumulator).

Dynamic Servo Control (DSC)

In drives that support DSC, you can optionally use the position controller in the drive. The position controller in the drive is usually implemented with a rapid speed-control cycle. This improves the control performance for digitally coupled drives.

Following error

The following error is the difference between the position setpoint and the actual position value. The transmission times of the setpoint to the drive, and of the actual position value to the controller, are taken into account in the calculation of the following error.

GSD file

As a Generic Station Description, this file contains all properties of a PROFINET or PROFIBUS device that are necessary for its configuration.

Hardware limit switch

Mechanical limit position switch that limits the maximum permissible traversing range of the axis.

Homing

With homing, you create the relationship between the position in the technology object and the mechanical position of the axis. The position value in the technology object is assigned to a homing mark at the same time. This homing mark represents a known mechanical position.

Incremental encoder

Position encoder which outputs the position change incrementally in the form of a digital numerical value.

Kv factor

Gain factor of the position controller

Master value

Input value for synchronous operation

Motion Control instruction

Use the Motion Control instructions to start Motion Control jobs at technology objects in your user program and thus execute the desired functionality at the technology objects. You track the status of running jobs with the output parameters of the Motion Control instructions.

Override

Percentage correction of the velocity/speed

Processing cycle clock

The processing of a technology object in the servo cycle clock.

PROFIdrive

PROFIdrive is a profile specified by the PNO (PROFIBUS user organization) for PROFIBUS DP and PROFINET IO for speed- and position-controlled drives.

PROFIdrive frame

Frame for communication according to PROFIdrive.

Relative gearing

Function corresponds to the Motion Control instruction MC_GearIn.

Restart

The technology object is reinitialized with the current configuration parameters.

Safe Stop 1 (SS1)

The Safe Stop 1 (SS1) safety function brings a drive to standstill quickly and safely via an internal rapid stop ramp. Safe Torque Off (STO) is activated after standstill. STO ensures that no more torque generating energy acts on a drive. This prevents unintended startup of the drive.

You can use the SS1 safety function when a fast stop of the drive with a subsequent transition to STO is required. SS1 is used, for example, to quickly stop high inertia loads or to brake drives quickly and safely at high speeds

Safe Stop 2 (SS2)

The Safe Stop 2 (SS2) safety function brings a drive to standstill quickly and safely via an internal rapid stop ramp. After standstill is reached, the standstill position is monitored on the drive side. The drive can deliver full torque to maintain the standstill.

SS2, for example, is used for processing machines and machine tools.

Safe Torque Off (STO)

The Safe Torque Off (STO) safety function is the most commonly used and most basic drive-internal safety function. STO ensures that no more torque generating energy acts on a drive. This prevents unintended startup of the drive. The pulses of the drive are eliminated. The drive is reliably torque-free. This state is monitored internally in the drive.

You can use STO when the drive comes to a standstill in a sufficiently short time on its own due to the load torque or due to friction. Other areas of use are where "coasting" of the drive has no relevance for safety.

Software limit switch

A programmable position which limits the traversing range of an axis.

Synchronization

The phase of the following axis to reach synchronous movement.

Synchronous operation

Defined synchronous movement after synchronization of a following axis to a leading axis.

Technology alarm

If an error occurs at a technology object (e.g. approaching a hardware limit switch), a technology alarm is triggered and indicated.

The impact of a technology alarm on the technology object is specified by the alarm reaction (e.g. remove enable). The alarm reaction is specified by the system.

Technology data block

The technology data block represents the technology object and contains all configuration data, setpoint and actual values, and status information of the technology object.

Technology module (TM)

Module for technological tasks, e.g. counting, measuring and positioning.

Zero mark

Position reference for the movement of rotary and linear incremental encoders. The zero mark of an incremental encoder is used as a homing mark, for example.

Index

A

Actuator, 16

C

Compatibility list, 177

D

Data type

DB_Any, 110

DB_Any, 110

Diagnostics

S7-1500 Motion Control, 134, 135, 139

Drive

Compatibility list, 177

Drives compatibility list, 51

E

Error ID, 139, 171

ErrorID

Basics, 134, 139

List of ErrorIDs, 171

Errors in Motion Control instructions, 134, 139, 171

External encoder

Adding, 60

Deleting, 62

Moving, 61

I

Interpolator OB, 23, 26

M

MC-Interpolator OB, 23, 26

MC-Servo OB, 23, 26

P

Positioning axis

Adding, 60

Deleting, 62

Moving, 61

Process image partition "OB Servo PIP", 26

R

Reduction ratio, 23

Reinitialization of technology objects, 127

Restart of technology objects, 127

S

S7-1500 Motion Control

Commissioning, 129, 130

Configuration, 60, 61, 62, 62, 63

Configuration limits, 20

Diagnostics, 134, 135, 139

Downloading to CPU, 128

Drive and encoder connection, 16, 51, 52, 55, 57

Guidelines for operation, 17

How it works, 12

Introduction, 11, 12

Motion Control instruction, 14, 104, 108

Motion Control Instruction, 112

Process response, 23, 26, 26, 29

Programming, 99, 104, 112, 127

Technology alarms, 134, 135, 140

Technology data block, 14, 99, 99, 101, 103

Technology object, 13, 60, 61, 62, 127

Unit of measure, 21

Versions, 32, 48

S7-1500 Motion Control commissioning, 129, 130

S7-1500 Motion Control drive

connection, 16, 51, 52, 55, 57

S7-1500 Motion Control encoder

connection, 16, 51, 52, 55, 57

S7-1500 Motion Control instruction, 14

Ending a Motion Control job, 126

Errors in Motion Control instructions, 134, 139, 171

Inserting, 108

Parameters, 104

Starting Motion Control job, 112

Tracking Motion Control job, 114

- S7-1500 Motion Control operating mode, 29
- Sensor, 16
- Servo OB, 23, 26
- SINAMICS V90 PN, 51
- Speed axis
 - Adding, 60
 - Deleting, 62
 - Moving, 61
- Startdrive, 51
- Synchronous axis
 - Adding, 60
 - Deleting, 62
 - Moving, 61

T

- Technology alarms
 - Basics, 134, 135
 - List of the technology alarms, 140
- Technology data block
 - Analyzing, 99
 - Basics, 14, 99
 - Change restart-relevant data, 103
 - Evaluating StatusWord, ErrorWord and WarningWord, 101
- Technology object
 - Data types, 110
 - External encoder, 60, 61, 62
 - Positioning axis, 60, 61, 62
 - Speed axis, 60, 61, 62
 - Synchronous axis, 60, 61, 62
- Technology objects, 13

U

- Unit of measure, 21