

SIEMENS

SIMATIC HMI

HMI device Mobile Panel 277 (WinCC flexible)

Operating Instructions

Order No. 6AV6691-1DL01-0AB0

08/2008
A5E00355986-02

Preface	
Overview	1
Safety instructions and general notes	2
Planning application	3
Installation and connection	4
Operator controls and displays	5
Configuring the operating system	6
Commissioning a project	7
Operating a project	8
Operating alarms	9
Operating recipes	10
Maintenance and care	11
Technical specifications	12
Appendix	A
Abbreviations	B

Legal information

Warning notice system

This manual contains notices you have to observe in order to ensure your personal safety, as well as to prevent damage to property. The notices referring to your personal safety are highlighted in the manual by a safety alert symbol, notices referring only to property damage have no safety alert symbol. These notices shown below are graded according to the degree of danger.

⚠ DANGER
indicates that death or severe personal injury will result if proper precautions are not taken.
⚠ WARNING
indicates that death or severe personal injury may result if proper precautions are not taken.
⚠ CAUTION
with a safety alert symbol, indicates that minor personal injury can result if proper precautions are not taken.
CAUTION
without a safety alert symbol, indicates that property damage can result if proper precautions are not taken.
NOTICE
indicates that an unintended result or situation can occur if the corresponding information is not taken into account.

If more than one degree of danger is present, the warning notice representing the highest degree of danger will be used. A notice warning of injury to persons with a safety alert symbol may also include a warning relating to property damage.

Qualified Personnel

The device/system may only be set up and used in conjunction with this documentation. Commissioning and operation of a device/system may only be performed by **qualified personnel**. Within the context of the safety notes in this documentation qualified persons are defined as persons who are authorized to commission, ground and label devices, systems and circuits in accordance with established safety practices and standards.

Proper use of Siemens products

Note the following:

⚠ WARNING
Siemens products may only be used for the applications described in the catalog and in the relevant technical documentation. If products and components from other manufacturers are used, these must be recommended or approved by Siemens. Proper transport, storage, installation, assembly, commissioning, operation and maintenance are required to ensure that the products operate safely and without any problems. The permissible ambient conditions must be adhered to. The information in the relevant documentation must be observed.

Trademarks

All names identified by ® are registered trademarks of the Siemens AG. The remaining trademarks in this publication may be trademarks whose use by third parties for their own purposes could violate the rights of the owner.

Disclaimer of Liability

We have reviewed the contents of this publication to ensure consistency with the hardware and software described. Since variance cannot be precluded entirely, we cannot guarantee full consistency. However, the information in this publication is reviewed regularly and any necessary corrections are included in subsequent editions.

Preface

Purpose of the operating instructions

These operating instructions provide information for manuals derived from the requirements for mechanical engineering documentation according to DIN EN 62079. This information relates to the HMI device, its place of use, transportation, storage, installation, use, and maintenance.

Readership of these operating instructions:

- Operators

The operator operates and monitors the plant within the process control phase. The following chapters are relevant to operators:

- Overview
- Operator controls and displays
- Configuring the operating system
- Operating a project
- Operating alarms
- Operating recipes
- Backing up and restoring data

- Commissioning engineers

The commissioning engineer integrates the HMI device into the plant and ensures proper functioning of the device for the process control phase.

The entire set of operating instructions is in principle relevant to the commissioning engineer.

Depending on the use of the HMI device, however, certain chapters may not be relevant to this engineer, for example, the chapter covering "Maintenance and servicing."

- Service technicians

The service technician troubleshoots faults that occur during the process control phase.

The entire set of operating instructions is basically relevant to the service technician.

Depending on the use of the HMI device, certain chapters may not be of relevance to the service technician, for example, the "Maintenance and servicing" chapter.

- Maintenance technicians

Maintenance technicians carry out routine maintenance work during the process control phase.

The chapter "Maintenance and servicing" is important for maintenance technicians.

All personnel operating the equipment must pay special attention to the chapter "Safety instructions and general notes."

The help integrated in WinCC flexible, the WinCC flexible Information System, contains detailed information. The information system contains instructions, examples and reference information in electronic form.

Basic knowledge required

General knowledge of automation technology and process communication is needed to understand the operating instructions.

It is also assumed that those using the manual have experience in using personal computers and knowledge of Microsoft operating systems.

Scope of the operating instructions

The operating instructions apply to the following HMI devices in conjunction with the software package WinCC flexible:

- Mobile Panel 277 8"
- Mobile Panel 277 10"

Position in the information landscape

These operating instructions form part of the SIMATIC HMI documentation. The following information provides you with an overview of the SIMATIC HMI information landscape.

User manuals

- WinCC flexible Micro
 - Describes basic principles of configuration using the WinCC flexible Micro Engineering System.
- WinCC flexible Compact/ Standard/ Advanced
 - Describes basic principles of configuration using the WinCC flexible Compact Engineering System/WinCC flexible Standard/WinCC flexible Advanced.
- WinCC flexible Runtime
 - Describes how to commission and operate your runtime project on a PC.
- WinCC flexible Migration
 - Describes how to convert an existing ProTool project to WinCC flexible.
 - Describes how to convert an existing WinCC project to WinCC flexible.
 - Describes how to convert an existing ProTool project including a change of the HMI device, for example from OP3 to OP 73 or from OP7 to OP 77B.
 - Describes how to convert an existing ProTool project including a change from a graphics device to a Windows CE device.
- Communication
 - Communication Part 1 describes the connection of the HMI device to SIMATIC PLCs.
 - Communication Part 2 describes the connection of the HMI device to third-party PLCs.

Operating instructions

- Operating instructions for SIMATIC HMI devices.
 - OP 73, OP 77A, OP 77B
 - TP 170micro, TP 170A, TP 170B, OP 170B
 - OP 73micro, TP 177micro
 - TP 177A, TP 177B, OP 177B
 - TP 270, OP 270
 - TP 277, OP 277
 - MP 177
 - MP 270B
 - MP 277
 - MP 370
 - MP 377
- Operating instructions for mobile SIMATIC HMI devices.
 - Mobile Panel 177
 - Mobile Panel 277
- Operating instructions (compact) for SIMATIC HMI devices.
 - OP 77B
 - Mobile Panel 177
 - Mobile Panel 277
- Operating instructions for SIMATIC accessories
 - Industrial USB Hub 4

Getting Started

- WinCC flexible for first time users

Based on an example project, this is a step-by-step introduction to the basics of configuring screens, alarms, recipes and screen navigation.
- WinCC flexible for power users

Based on an example project, this is a step-by-step introduction to the basics of configuring logs, project reports, scripts, user management, multilingual projects and integration in STEP 7.
- WinCC flexible options

Based on an example project, this is a step-by-step introduction to the basics of configuring the WinCC flexible Sm@rtServices, Sm@rtAccess and OPC server options.

Online availability

Technical documentation on SIMATIC products and SIMATIC systems is available in PDF format in various languages at the following address:

["http://www.automation.siemens.com/simatic/portal/html_76/techdoku.htm"](http://www.automation.siemens.com/simatic/portal/html_76/techdoku.htm)

Screens

The HMI device is sometimes shown in the form of photographs in these operating instructions. The photographs of the HMI device may differ slightly from the factory state of the HMI device.

Conventions

Configuration and runtime software differ with regard to their names as follows:

- "WinCC flexible 2008" for example, refers to the configuration software.
The term "WinCC flexible" is used in a general context. The full name, for example "WinCC flexible 2008", is always used when it is necessary to differentiate between different versions of the configuration software.
- "WinCC flexible Runtime" refers to the runtime software that can run on HMI devices.
- The name "Mobile Panel 277" applies to the following HMI devices:
 - Mobile Panel 277 8"
 - Mobile Panel 277 10"

The following text notation will facilitate reading these operating instructions:

Notation	Scope
"Add screen"	<ul style="list-style-type: none">• Terminology that appears in the user interface, for example dialog names, tabs, buttons, menu entries• Inputs required, for example limit values, tag values• Path information
"File > Edit"	Operational sequences, for example, menu commands, shortcut menu commands
<F1>, <Alt+P>	Keyboard operation

Please observe notes labeled as follows:

Note

Notes contain important information concerning the product, its use or a specific section of the documentation to which you should pay particular attention.

Registered trademarks

Names labeled with a ® symbol are registered trademarks of the Siemens AG. Other names used in this documentation may be trademarks, the use of which by third parties for their own purposes could violate the rights of the owner.

- HMI®
- SIMATIC®
- SIMATIC HMI®
- SIMATIC ProTool®
- SIMATIC WinCC®
- SIMATIC WinCC flexible®

Representatives and offices

If you have any further questions relating to the products described in this manual, please contact your local representative at the Siemens branch nearest you.

Find your contact person at "<http://www.siemens.com/automation/partner>".

Training center

Siemens AG offers a variety of training courses in order to familiarize you with automation systems. Please contact your regional training center, or our central training center in 90327 Nuremberg, Germany, for details.

Phone: +49 (911) 895-3200

Internet: "<http://www.sitrain.com>"

Technical Support

Technical support for all SIMATIC products is available:

Using the Web form to request support

"<http://www.siemens.com/automation/support-request>"

Phone: + 49 180 5050 222

Fax: + 49 180 5050 223

You will find more information on our technical support on the Internet at "<http://support.automation.siemens.com>".

Service & Support on the Internet

Service & Support provides additional comprehensive information on SIMATIC products through online services at "<http://support.automation.siemens.com>".

- The newsletter offers you the latest information about your products
- A large document base is available using our Service & Support search engine
- A forum for global exchange of information by users and experts
- Current product information, FAQs and downloads
- You local representative
- Information about on-site services, repairs, spare parts, and more

Table of contents

	Preface	3
1	Overview	15
1.1	Product Overview.....	15
1.2	Design of the HMI device.....	16
1.2.1	Overview	16
1.2.2	Structure of Mobile Panel 277 8"	17
1.2.3	Structure of Mobile Panel 277 10"	19
1.3	Accessory kit for Mobile Panel 277 8"	20
1.4	Accessories.....	21
1.4.1	Connecting Cable	21
1.4.2	Connection Box.....	22
1.4.3	Rechargeable buffer battery	24
1.4.4	Wall holder	25
1.4.5	PC/PPI cable.....	26
1.4.6	USB/PPI cable	26
1.4.7	Protective foil.....	26
1.4.8	Touch pens	26
1.4.9	Memory card	27
1.5	Functional scope with WinCC flexible.....	27
1.6	Software Options	30
1.7	Communications	30
2	Safety instructions and general notes	33
2.1	Safety Instructions	33
2.2	Standards, Certificates and Approvals.....	34
2.3	Operating safety.....	36
2.4	Voltage supply.....	37
2.5	Notes about Usage	37
2.6	Risk analysis	38
2.7	Enabling Switch	38
2.8	STOP Button	40
2.9	Electromagnetic Compatibility.....	41
2.10	Transport and Storage Conditions.....	43
3	Planning application	45
3.1	Notes about Usage	45
3.2	Mounting positions and type of fixation.....	47
3.3	Preparing for mounting	48
3.4	Specifications for Insulation Tests, Protection Class and Degree of Protection.....	50

3.5	Rated voltages	50
4	Installation and connection	51
4.1	Checking the Package Contents.....	51
4.2	Mounting the Connection Box and Wall Holder	51
4.3	Electrical Installation	53
4.4	Connecting the connection box.....	53
4.4.1	Overview	53
4.4.2	Opening and closing the connection box.....	54
4.4.3	Setting the box ID at the connection box	56
4.4.4	Stripping the Insulation of Cables	58
4.4.5	Connecting the equipotential bonding circuit	59
4.4.6	Connecting the PLC	61
4.4.7	Connecting a Configuring PC	64
4.4.8	Connecting a printer to a connection box PN	66
4.4.9	Connecting the Power Supply.....	67
4.5	Connecting Mobile Panel 277	69
4.5.1	Connecting the HMI device.....	69
4.5.2	Opening and Closing the Terminal Compartment	69
4.5.3	Mobile Panel 277 ports	71
4.5.4	Connecting a Configuring PC	74
4.5.5	Connecting the Connecting Cable	75
4.6	Switching on and testing the HMI device.....	77
5	Operator controls and displays	79
5.1	Overview	79
5.1.1	Mobile Panel 277 8"	79
5.1.2	Mobile Panel 277 10"	81
5.2	Operator controls of Mobile Panel 277 8"	82
5.2.1	STOP button	82
5.2.1.1	Overview	82
5.2.1.2	Safety Functions of the STOP Button	84
5.2.2	Handwheel	85
5.2.3	Illuminated Pushbutton.....	86
5.2.4	Key-operated Switch	87
5.2.5	Enabling Switch.....	88
5.2.6	Display the charge status of the bridging battery.....	90
5.2.7	Configuring the evaluation of operator controls	91
5.2.7.1	Overview	91
5.2.7.2	Evaluating operator controls as direct keys	92
5.2.7.3	Controlling the LEDs of the function keys by means of system functions	95
5.2.7.4	Evaluating the handwheel by means of system functions	96
5.2.7.5	Evaluating the key-operated switch by means of system functions	96
5.2.7.6	Controlling and evaluating the illuminated pushbutton by means of system functions	97
5.3	Operator controls of Mobile Panel 277 10"	98
5.3.1	STOP button	98
5.3.1.1	Overview	98
5.3.1.2	Safety Functions of the STOP Button	100
5.3.2	Enabling Switch.....	101
5.3.3	Configuring the evaluation of operator controls	104
5.3.3.1	Overview	104
5.3.3.2	Evaluating operator controls as direct keys	104

5.4	Using memory cards	105
5.5	Labeling the function keys on Mobile Panel 277 8"	106
5.6	Holding the Mobile Panel and attaching it to the wall holder	109
5.7	Connection box	111
5.7.1	STOP button on the connection box Plus	111
5.7.2	STOP button on the connection box Basic	112
5.7.3	Displays on the connection box PN	114
6	Configuring the operating system	115
6.1	Loader	115
6.2	Control Panel	118
6.2.1	Overview	118
6.2.2	Reference	119
6.2.3	Operating the Control Panel	120
6.3	Changing settings for operation	122
6.3.1	Configuring the Screen Keyboard	122
6.3.2	Setting the Character Repetition of the Keyboard	123
6.3.3	Setting the Double-click	125
6.3.4	Calibrating the Touch Screen	126
6.4	Changing Password Protection	128
6.5	Changing HMI device settings	129
6.5.1	Setting the date and time	129
6.5.2	Changing Regional Settings	131
6.5.3	Backing up Registry Information	132
6.5.4	Changing Screen Settings	134
6.5.5	Setting the screen saver	135
6.5.6	Changing the Printer Properties	136
6.5.7	Restarting the HMI Device	138
6.5.8	Displaying Information about the HMI Device	139
6.5.9	Displaying System Properties	140
6.6	Setting the Delay Time	141
6.7	Communication settings	143
6.7.1	Changing MPI/PROFIBUS DP Settings	143
6.7.2	Configuring the data channel	145
6.7.3	Enabling PROFINET IO	148
6.8	Configuring network operation	149
6.8.1	Overview of network operation	149
6.8.2	Setting the device name of the HMI device	151
6.8.3	Changing the Network Configuration	152
6.8.4	Changing the Logon Data	153
6.8.5	Changing E-Mail Settings	154
6.8.6	Changing internet settings	155
6.8.6.1	Changing General Internet Settings	155
6.8.6.2	Setting the Proxy Server	156
6.8.6.3	Changing Privacy Settings	157
6.8.6.4	Importing and Deleting Certificates	159
6.9	Backup and Restore with the Memory Card	160
6.10	Display rechargeable battery charge level	163
6.11	Activate Memory Management	164

7	Commissioning a project	165
7.1	Overview	165
7.2	Operating modes.....	166
7.3	Using existing projects	167
7.4	Data Transmission Options.....	167
7.5	Transfer	168
7.5.1	Overview	168
7.5.2	Starting manual transfer.....	169
7.5.3	Starting automatic transfer	170
7.5.4	Starting backtransfer	171
7.5.5	Testing a project.....	172
7.6	Backup and restore	174
7.6.1	Overview	174
7.6.2	Backup and restore using WinCC flexible.....	175
7.6.3	Backup and restore using ProSave	177
7.7	Updating the operating system	178
7.7.1	Overview	178
7.7.2	Reset to factory settings.....	179
7.7.3	Updating the operating system using WinCC flexible.....	179
7.7.4	Updating the operating system using ProSave.....	180
7.8	Installing and removing options	182
7.8.1	Overview	182
7.8.2	Installing and removing options using WinCC flexible	182
7.8.3	Installing and removing options using ProSave.....	184
7.9	Transferring and transferring license keys.....	185
7.9.1	Overview	185
7.9.2	Transferring and transferring back license keys	185
8	Operating a project	189
8.1	Overview	189
8.2	Direct keys	192
8.3	Setting the project language	193
8.4	Entering values using the touch screen	194
8.4.1	Overview	194
8.4.2	Entering and editing numerical values	195
8.4.3	Entering and editing alphanumerical values	197
8.4.4	Entering the date and time	198
8.4.5	Entering symbolic values	199
8.4.6	Displaying infotext	199
8.5	Function keys	201
8.6	Bar and gauge.....	202
8.7	Operating the switch	203
8.8	Operating the slider control	204
8.9	Operating the trend view	205
8.10	Operating the status force.....	207
8.10.1	Overview	207

8.10.2	Operation	208
8.11	Operating the Sm@rtClient view	209
8.11.1	Overview	209
8.11.2	Operation	210
8.12	Project security	212
8.12.1	Overview	212
8.12.2	User view	213
8.12.3	User logon.....	215
8.12.4	User logoff.....	216
8.12.5	Creating users.....	216
8.12.6	Changing user data.....	218
8.12.7	Deleting users	219
8.13	Closing the project	219
9	Operating alarms	221
9.1	Overview	221
9.2	Recognizing pending alarms.....	223
9.3	Displaying alarms.....	223
9.4	Display infotexts for an alarm.....	226
9.5	Acknowledge alarm.....	226
9.6	Edit alarm	227
10	Operating recipes	229
10.1	Overview	229
10.2	Structure of a recipe.....	230
10.3	Recipes in the project	232
10.4	Displaying a recipe.....	234
10.5	Recipe values in the HMI device and the PLC	237
10.6	Operating the recipe view	238
10.6.1	Overview	238
10.6.2	Creating a recipe data record	239
10.6.3	Editing a recipe data record	240
10.6.4	Deleting a recipe data record.....	241
10.6.5	Synchronizing tags.....	242
10.6.6	Reading a recipe data record from the PLC	243
10.6.7	Transferring a recipe data record to the PLC	244
10.7	Operating the simple recipe view.....	244
10.7.1	Overview	244
10.7.2	Creating a recipe data record	246
10.7.3	Editing a recipe data record	247
10.7.4	Deleting a recipe data record.....	248
10.7.5	Reading a recipe data record from the PLC	249
10.7.6	Transferring a recipe data record to the PLC	250
10.8	Exporting a recipe data record.....	251
10.9	Importing a recipe data record.....	252
10.10	Examples	253
10.10.1	Entering a recipe data record.....	253

10.10.2	Manual production sequence	254
11	Maintenance and care	255
11.1	Maintenance and care.....	255
11.2	Spare Parts and Repairs.....	256
12	Technical specifications	257
12.1	Dimension drawings.....	257
12.1.1	Mobile Panel 277 8".....	257
12.1.2	Mobile Panel 277 10".....	259
12.1.3	Wall holder	261
12.1.4	Connection box DP	262
12.1.5	Connection box PN	263
12.2	Specifications	264
12.2.1	Mobile Panel 277 8".....	264
12.2.2	Mobile Panel 277 10".....	265
12.2.3	Rechargeable buffer battery	267
12.2.4	Connection box DP	267
12.2.5	Connection box PN	268
12.3	Mobile Panel 277 port assignments.....	269
12.3.1	RS 485 (IF 2).....	269
12.3.2	USB.....	270
12.3.3	RJ45 for connecting cable DP	270
12.3.4	RJ45 for connecting cable PN	271
12.3.5	Post connector for connecting cable DP.....	271
12.3.6	Post connector for connecting cable PN.....	272
12.4	Port assignment on the connection box DP.....	272
12.5	Port Assignment on the Connection Box PN	274
12.6	Port assignment on the connection box DP and connection box PN	276
12.7	Wiring Examples for Enabling Switch and STOP Button.....	282
A	Appendix.....	285
A.1	ESD guideline	285
A.2	System alarms	287
A.3	Things to remember during configuration	317
A.3.1	Configuring the terminal ID	317
A.3.1.1	Overview	317
A.3.1.2	Connection Point Recognition via Box ID	318
A.3.2	Ensuring consistent values for operator controls.....	320
B	Abbreviations.....	323
	Glossary	325
	Index.....	331

Overview

1.1 Product Overview

Expanded application options – with Mobile Panel 277

SIMATIC Mobile Panels offer the option of making safety functions available on a mobile basis at any point of a machine or plant.

The Mobile Panel 277 compliments the product range at the high-performance end of the spectrum, in relation to the well-known 170 and 177 series mobile HMI devices.

The Mobile Panel lets you use text or graphic based projects even more efficiently for simple and medium-complexity control and monitoring tasks on machines and plants.

The Mobile Panel 277 is characterized by short commissioning times, a large user memory, high-performance, and is flexibly optimized for projects based on WinCC.

In addition, the Mobile Panel 277 comes with the following features:

- PROFIBUS and Ethernet ports
- 8" or 10" TFT screen with 64k colors
- 18 function keys with LED on Mobile Panel 277 8"
- Extended HMI functions

1.2 Design of the HMI device

1.2.1 Overview

The following figure shows the Mobile Panel 277 8" connected to a connection box DP.



- ① Mobile Panel 277 8"
- ② Connection box DP
- ③ Connecting cable DP
- ④ Cable for power supply and safety functions
- ⑤ Cable for process connection

Combinations

You can connect the Mobile Panel 277 to PROFIBUS DP or PROFINET.

The following table shows which connection box and which connecting cable can be combined. Only the combinations listed in the table are possible.

Data network	Connection box	Connecting cables
PROFIBUS DP	Connection box DP Basic Connection box DP Plus	Connecting cable DP
PROFINET	Connection box PN Basic Connection box PN Plus	Connecting cable PN

The connecting cable contains the lines for the process connection, the safety functions, and the power supply. The connecting cable is available in different lengths on separate order. Carry out the cabling for the power supply and safety functions plant-specifically.

The Mobile Panel 277 can be securely stored in its wall holder.

1.2.2 Structure of Mobile Panel 277 8"

Delivery includes the HMI device and an accessory kit.

The Mobile Panel 277 is available in three design variations:

- With enabling button
- With enabling button and STOP button
- With enabling button, STOP button, handwheel, key-operated switch and two illuminated pushbuttons.

Front view

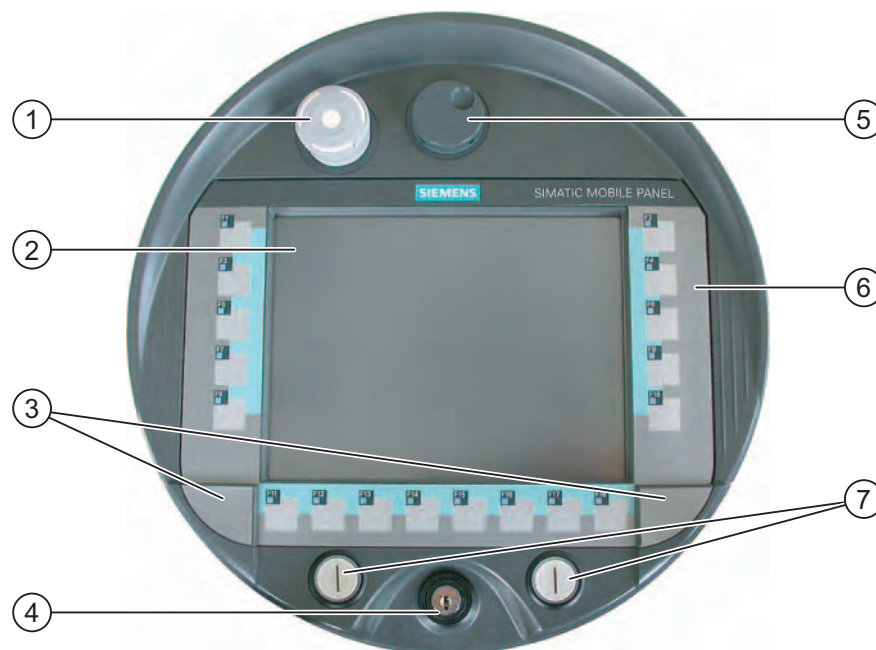

- ① STOP button, optional
- ② Display with touch screen
- ③ Covers for the labeling strip guides
- ④ Key-operated switch, optional
- ⑤ Handwheel, optional
- ⑥ Membrane keyboard
- ⑦ Illuminated pushbutton, optional

Side view

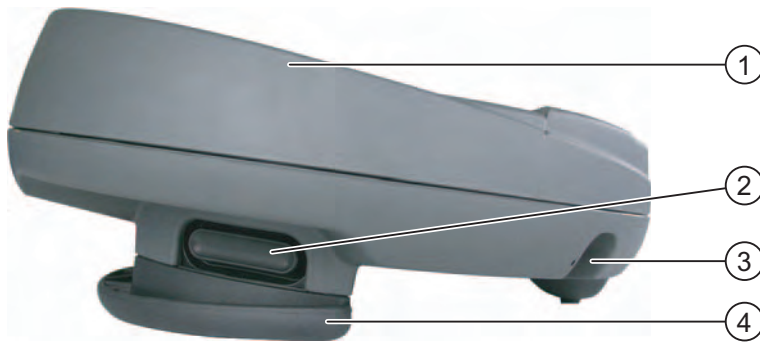

- ① Fall protection for the STOP button
- ② Enabling buttons on the left and right side of the HMI device
- ③ Cable inlet
- ④ Handle

Rear view

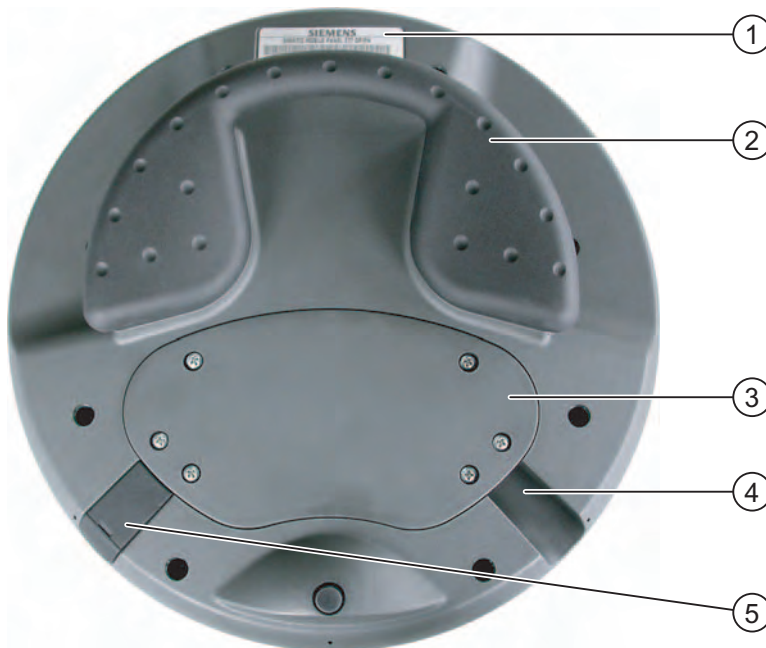

- ① Rating label
- ② Handle
- ③ Connection bay cover
- ④ Cable inlet
- ⑤ USB port and plugs

1.2.3 Structure of Mobile Panel 277 10"

Front view



- ① STOP button
- ② Display with touch screen

Side view



- ① Impact guards
- ② Enabling buttons on the left and right side of the HMI device
- ③ Handle

Rear view

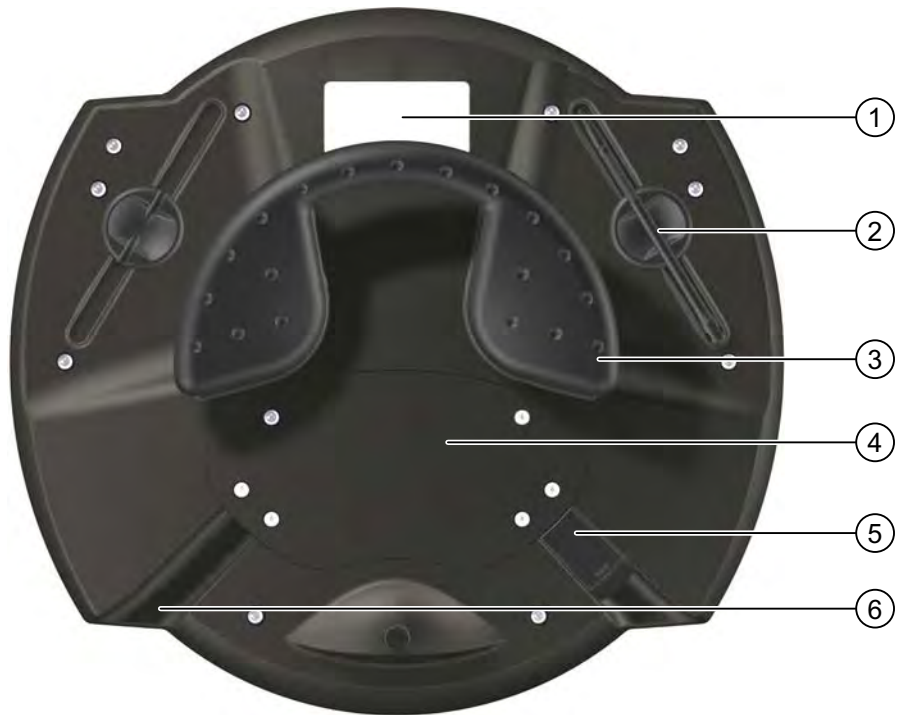

- ① Rating label
- ② Holder for the touch pen
- ③ Handle
- ④ Connection bay cover
- ⑤ USB port and plugs
- ⑥ Cable inlet

Touch pens are available as accessories; see Touch pens (Page 26).

1.3 Accessory kit for Mobile Panel 277 8"

The accessory kit is supplied with the HMI device.

The accessory kit contains the following:

- Cover cap with rubber seal
- Screws for fixing the cover cap
- Label for cover cap

The accessory kit can include documents.

1.4 Accessories

1.4.1 Connecting Cable

The connecting cable is an industrial cable and, thus, resistant to many solvents and lubricants. The flexural strength of the connecting cable is geared to the actual usage conditions.

The connecting cable is available in two models:

- Connecting cable DP
For connecting the Mobile Panel 277 to the connection box DP
- Connecting cable PN
For connecting the Mobile Panel 277 to the connection box PN

The connecting cables are available in different lengths. For additional information, refer to the Internet at "<http://mall.automation.siemens.com>"

Design of the connecting cable

The following figure shows the connecting cable DP.



- ① Metallic push-pull circular connector
- ② Strain relief and antikink device for the connection cable
- ③ RJ45 connector
- ④ Plug connector, 10-pin

The following figure shows the connecting cable PN.



- ① Metallic push-pull circular connector
- ② Strain relief and antikink device for the connection cable
- ③ RJ45 connector
- ④ Plug connector, 12-pin

Note

When inserted, the circular connector guarantees protection class IP65.

1.4.2 Connection Box

Design

The following figure shows the connection box DP.



- ① Screwed joint for process data line
- ② Threaded assembly for power supply cable
- ③ Threaded assembly for cable with supplementary Stop and enabling button signals and for PLC-accompanying signals
- ④ Connecting socket for the connecting cable
- ⑤ Dummy cap

The following figure shows the connection box PN.



- ① Screwed joint for process data line
- ② LEDs
- ③ Threaded assembly for power supply cable
- ④ Threaded assembly for cable with supplementary Stop and enabling button signals and for PLC-accompanying signals
- ⑤ Connecting socket for the connecting cable - covered with dummy cap

NOTICE

IP65 degree of protection

Degree of protection IP65 is guaranteed for the connection box when the Mobile Panel 277 is connected or when a dummy cap is inserted.

Variants

The connection boxes are available in the following variants:

- Connection box Basic
- Connection box Plus

The difference between the two variants lies in the evaluation of the signals from the stop or Emergency Stop circuits of the plant.

Note

The exterior of the connection box variants differ only in the printing on the side.

Note

Recovery time

Wait for approximately one second after you have removed the connecting cable from the connection box before you plug the connecting cable back in.

After power failures lasting less than one second the connecting cable has to be disconnected.

Division of the system into zones

You can divide a system into various zones or functional areas by using numerous connection boxes. You can also set up the safety functions zone-dependently. This means that both enabling buttons and STOP buttons can act in only one particular zone and not in others.

Connection point recognition

You can set an individual box ID for each connection box. The box ID allows connection points to be recognized.

Combination of connecting cable and connection box

It is ensured by mechanical means that only the following combinations can be connected:

- Mobile Panel 277 with connecting cable DP on the connection box DP
- Mobile Panel 277 with connecting cable PN on the connection box PN

1.4.3 Rechargeable buffer battery

The rechargeable buffer battery avoids the need to restart the Mobile Panel when changing between different connection boxes.

The maximum buffer time is 10 minutes. The rechargeable battery is able to bridge the buffer time 5 times without recharging. During the buffer time, the backlight of the display is switched off.

When the mobile panel is connected to a connection box, the rechargeable battery is charged automatically.

NOTICE
Recharging and discharging the rechargeable battery
In the following cases, there is a risk of fire and, in extreme cases, explosion!
<ul style="list-style-type: none">• Incorrect charging and discharging of the rechargeable battery• Reverse polarity• Short-circuit
The rechargeable battery may only be recharged in the mobile panel.

Note

The HMI device may supply the same system alarms as it would do in the event of a communication interrupt when reconnecting the HMI device to another connection box.

Safety instructions

The rechargeable battery is a Li-ion rechargeable battery. The following safety notes apply to these rechargeable batteries:

- Do not crush.
- Do not expose to heat and do not burn.
- Do not short-circuit.
- Do not take apart.
- Do not immerse in liquid – the battery might crack or burst.

Ordering information

The rechargeable buffer battery is not included with the HMI device.

Note

You may only use the battery option package as of product version 02. The product version is available on the battery.

The rechargeable battery is available under the order number 6AV6671-5AD00-0AX0.

1.4.4 Wall holder

The wall holder provides a safe hold for the Mobile Panel 277 when used in stationary mode.

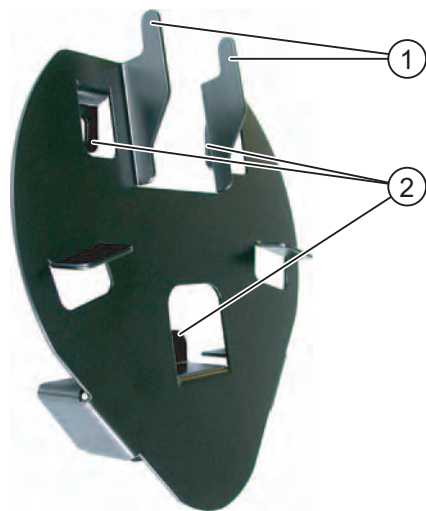

- ① Hook for the grip on the HMI device
- ② Screw flange

The wall holder is not included with the HMI device. The wall holder is available with order number 6AV6574-1AF04-4AA0.

1.4.5 PC/PPI cable

You need the cable to update the HMI device image via the RS 232 serial interface of the configuration PC. You can also use the cable for data transfer. Connect the PC/PPI cable to the RS 485 port of the HMI device.

Note

If the connection fails during the operating system update, set the system to a lower bit rate. If you use a higher bit rate, you must use the PC/PPI cable release 3 or higher. The version code is printed on the cable (e.g., "E-Stand 3" corresponds to version 3).

The PC/PPI cable is not included with the HMI device. The cable is available with order number 6ES7 901-3CB30-0XA0.

1.4.6 USB/PPI cable

You need the cable to update the operating system by resetting to factory settings via the USB port of the configuration PC. Connect the PC/PPI cable to the RS 485 port of the HMI device.

Note

Use a USB/PPI cable, version 5 or higher. The version code is printed on the cable (for example, "E-Stand 5" corresponds to version 5).

The USB/PPI cable is not included with the HMI device. The cable is available with order number 6ES7 901-3DB30-0XA0.

1.4.7 Protective foil

The protective foil prevents the touch screen from being scratched or soiled.

The protective foil kit is not included with the HMI device. The 10-piece protective foil kit has the following order numbers:

- 6AV6671-5BC00-0AX0 for Mobile Panel 277 8"
- 6AV6645-7AB15-0AS0 for Mobile Panel 277 10"

1.4.8 Touch pens

The touch pens make it easier to operate the touch screen.

The touch pen set is not included with the HMI device. The set of 5 touch pens is available with order number 6AV6645-7AB14-0AS0.

1.4.9 Memory card

You can use a memory card to back up data from the HMI device and to copy data onto the HMI device. Only use the SD memory cards or multimedia cards tested and released by Siemens.

A memory card is not included with the HMI device. The memory card can be ordered using the Siemens online catalog. For additional information, refer to the Internet at "<http://mall.automation.siemens.com>".

1.5 Functional scope with WinCC flexible

The following tables show the objects that can be integrated into a project for a Mobile Panel 277.

Alarms

Object	Specification	Mobile Panel 277
Alarm	Number of discrete alarms	4.000
	Number of analog alarms	200
	Length of the alarm text	80 characters
	Number of tags in an alarm	Max. 8
	Display	Alarm line, Alarm window, Alarm view
	Acknowledge error alarms individually	Yes
	Acknowledge several error alarms simultaneously (group acknowledgment of alarm groups)	16 alarm groups
	Edit alarm	Yes
	Alarm indicator	Yes
ALARM_S	Display S7 alarms	Yes
Alarm buffer retentive	Alarm buffer capacity	512 alarms
	Simultaneously queued alarm events	Max. 250
	View alarm	Yes
	Delete alarm buffer	Yes
	Line-by-line printing of alarms	Yes

Tags, values and lists

Object	Specification	Mobile Panel 277
Tag	Number	2.048
Limit value monitoring	Input/Output	Yes
Linear scaling	Input/Output	Yes
Text list	Number	500 ¹⁾
Graphics list	Number	400 ¹⁾

¹⁾ The maximum total of text and graphics lists is 500.

Screens

Object	Specification	Mobile Panel 277
screen	Number	500
	Fields per screen	200
	Tags per screen	200
	Complex objects per screen (e.g. bars)	10
	Template	Yes

Recipes

Object	Specification	Mobile Panel 277
Recipe	Number	300
	Data records per recipe	500
	Entries per recipe	1.000
	Recipe memory	64 KB
	Memory location	<ul style="list-style-type: none"> • Memory card ¹⁾ • USB memory stick ¹⁾ • Network drive

¹⁾ The number of recipe data records might be restricted by the capacity of the storage medium.

Logs

Note

The HMI devices are suitable for the logging of relatively small volumes of data.

Manage the data in several adjacent archives in a segmented circular archive. The use of a large circular archive has a negative effect on performance.

Object	Specification	Mobile Panel 277
Logs	Number of logs	20
	Number of sub-archives with segmented circular log	400
	Entries in each log including all partial logs	10.000
	Filing format	CSV with ANSI character set
	Memory location	<ul style="list-style-type: none"> • Memory card ¹⁾ • USB memory stick ¹⁾ • Network drive

¹⁾ The number of entries in the log may be restricted by the capacity of the storage medium.

Safety

Object	Specification	Mobile Panel 277
Safety	Number of user groups	50
	Number of users	50
	Number of authorizations	32

Infotexts

Object	Specification	Mobile Panel 277
Infotext	Length (no. of characters)	320 (depending on font)
	For alarms	Yes
	For screens	Yes
	For screen objects (for example for I/O field, switch, button, invisible button)	Yes

Additional functions

Object	Specification	Mobile Panel 277
Monitor setting	Touch screen calibration	Yes
	Brightness setting	Yes
Language change	Number of languages	16
VBScript	User-specific extension of the functionality	Yes
	Number of scripts	50
Graphic object	Vector and pixel graphics	Yes
Trends	Number	300
Task planner	Number of tasks	48
Text objects	Number	10.000
Direct keys	PROFIBUS DP direct keys	Yes
	PROFINET IO direct keys	Yes

1.6 Software Options

The following software options are available for the Mobile Panel 277:

- WinCC flexible /Sm@rtService

The WinCC flexible /Sm@rtService option lets you to access a remote HMI device from your HMI device or PC via Ethernet.

- WinCC Flexible/Sm@rtAccess

The WinCC flexible / Sm@rtAccess option can be used to implement communication between different HMI systems.

- WinCC flexible /Audit

The WinCC flexible /Audit option enhances functionality of the HMI device with functionality for recording operator actions in an audit trail and electronic signatures.

- WinCC flexible /OPC server (OPC XML)

The WinCC flexible /OPC server option lets you set up the communication with OPC-compatible applications from an HMI device or PC via Ethernet.

1.7 Communications

Number of connections

Connection	Mobile Panel 277
Number using a bus connection	6
Number of connections based on "SIMATIC HMI HTTP Protocol"	8

Note

In the following cases, you may not enable PROFINET IO in the Control Panel:

- Use of PLCs from other manufacturers
- Use of SIMATIC 500/505 via NITP
- Use of SIMATIC S5 via AS511

Compatible PLCs

The following table shows the supported PLCs, protocols or profiles.

PLC	Protocol
SIMATIC S7	<ul style="list-style-type: none"> • PPI • MPI 1) • PROFIBUS DP • TCP/IP (Ethernet)
SIMATIC S5	<ul style="list-style-type: none"> • PROFIBUS DP • AS 511

PLC	Protocol
SIMATIC 500/505	<ul style="list-style-type: none"> NITP PROFIBUS DP
SIMATIC HMI HTTP protocol	<ul style="list-style-type: none"> HTTP/HTTPS (Ethernet)
Allen-Bradley, PLC series: SLC500, SLC501, SLC502, SLC503, SLC504, SLC505, MicroLogix and PLC5/11, PLC5/20, PLC5/30, PLC5/40, PLC5/60, PLC5/80	<ul style="list-style-type: none"> DF1 ^{2) 5) 6)} DH+ via KF2 module ^{3) 5) 6)} DH485 via KF3 module ^{4) 5) 6)} DH485 ⁴⁾
Allen-Bradley, PLC series: ControlLogix 5500, CompactLogix 5300	<ul style="list-style-type: none"> Allen-Bradley E/IP C.Logix (Ethernet IP)
GE Fanuc Automation; PLC series: 90-30, 90-70, VersaMax Micro	<ul style="list-style-type: none"> SNP ^{5) 6)}
LG Industrial Systems (Lucky Goldstar)/IMO; PLC series: GLOFA GM (GM4, GM6 and GM7)/series G4, G6 and G7	<ul style="list-style-type: none"> Dedicated communication ^{5) 6)}
Mitsubishi Electric; PLC series: MELSEC FX and MELSEC FX0	<ul style="list-style-type: none"> FX ^{5) 6)}
Mitsubishi Electric; PLC series: MELSEC FX0, FX1n, FX2n, AnA, AnN, AnS, AnU, QnA and QnAS	<ul style="list-style-type: none"> Protocol 4 ^{5) 6)}
OMRON; PLC series: SYSMAC C, SYSMAC CV, SYSMAC CS1, SYSMAC alpha and CP	<ul style="list-style-type: none"> Hostlink/Multilink (SYSMAC Way) ^{5) 6)}
Modicon (Schneider Automation); PLC series: Modicon 984, TSX Quantum and TSX Compact	<ul style="list-style-type: none"> Modbus RTU ^{5) 6)}
Modicon (Schneider Automation); PLC series: <ul style="list-style-type: none"> Quantum, Momentum, Premium and Micro Compact and 984 via Ethernet bridge 	<ul style="list-style-type: none"> Modbus TCP/IP (Ethernet)
Telemecanique; PLC series: <ul style="list-style-type: none"> TSX 7 with P47 411 TSX 7 with P47/67/87/107 420 TSX 7 with P47/67/87/107 425 Module TSX SCM 21.6 with aforementioned TSX 7 CPUs TSX 17 with module SCG 1161 TSX 37 (Micro) TSX 57 (Premium) 	<ul style="list-style-type: none"> Uni-Telway ^{5) 6)}

- 1) Not supported for connections to SIMATIC S7-212
- 2) Applies to PLCs SLC503, SLC504, SLC505, PLC5, MicroLogix
- 3) Applies to PLCs SLC504, PLC5 over DF1
- 4) Applies to PLCs SLC500 to SLC 505 and MicroLogix
- 5) PROFINET IO must be locked.
- 6) The "Remote Control" check box at "Channel 1" in the "Transfer Settings" must be deactivated.

Compressing the internal program memory with SIMATIC S5

 **CAUTION**

Compressing the internal program memory

Compressing the internal program memory of the SIMATIC S5 PLC ("Compress" programming device function, integrated FB COMPR) is not permitted if an HMI device is connected! When memory is compressed, the absolute addresses of the blocks in the program memory change. Since the HMI device only reads the address list during startup, it does not recognize the address change and accesses the wrong memory areas.

If you cannot avoid compressing memory during operation, turn off the HMI device before running the compress function.

Safety instructions and general notes

2.1 Safety Instructions

Safety regulations

 WARNING
Strictly observe all instructions in these operating instructions at all times. Otherwise, hazardous situations can arise or the safety mechanisms in the HMI device can be rendered ineffective.

Observe the safety and accident prevention instructions applicable to your application in addition to the safety instructions given in this manual.

 WARNING
The configuration engineer for a machine or system PLC must take precautions so that an interrupted program can be restarted normally after voltage dips or power failures. Dangerous operating conditions must not occur, even temporarily.
If faults in the system can cause bodily injury or significant property damage, additional measures must be taken outside of the system. These measures must also ensure safe operating conditions in the system in the event of a fault.
The system's configuration engineer must take precautions to ensure that memory changes that could lead to a dangerous situation can only be undertaken by authorized persons.
The STOP button must be checked periodically for proper functioning.

 WARNING
After a hard impact to the HMI device, check the safety-relevant features for functional capability, for example in the event that the HMI device is dropped.
Manual actions performed with the HMI device may only occur in conjunction with the enabling buttons and at reduced velocity.
If the system is operated with the HMI device:
Ensure that current operation is only possible by means of the HMI device and not from any other point on the system.

Proper use

 WARNING
Commissioning of the HMI device is forbidden until it has been absolutely ensured that the machine in which the HMI device is to be installed complies with Directive 98/37/EC or Directive 2006/42/EC as of 29 December 2009.

High frequency radiation

NOTICE
Unintentional operating situations High-frequency radiation, for example from cellular phones, can lead to undesirable operating situations.

2.2 Standards, Certificates and Approvals

Certifications

 CAUTION
The following overview shows possible approvals. The only valid approvals for the HMI device and the connection box itself are those shown on the label on the rear panel.

CE approval



The HMI device and the connection box satisfy the requirements and protection objectives of the following EC Directory. The HMI device and the connection box comply with the harmonized European standards (EN), promulgated in the Official Journals of the European Community for programmable controllers:

- 2004/108/EC "Electromagnetic Compatibility" (EMC Directive)
- Directive 2006/95/EC "Electrical Equipment Designed for Use within Certain Voltage Limits" (LowVoltage Directive)

EC Declaration of Conformity

The EC Declarations of Conformity are available to the relevant authorities at the following address:

Siemens Aktiengesellschaft
Industry Sector
I IA AS RD ST PLC
P.O. Box 1963
D-92209 Amberg

UL approval



Underwriters Laboratories Inc., conforming to

- UL 508 (Industrial Control Equipment)
- CSA C22.2 No. 142 (Process Control Equipment)

Marking for Australia



The HMI device and the connection box satisfy the requirements of Standard AS/NZS 2064 (Class A).

SIBE Switzerland Certification Service



The HMI device and the connection box satisfy Safety Category 3 in accordance with EN 954-1.

The enabling device safety function for special operation control and the STOP button satisfy the following requirements:

- Safety category 3 according to EN 954-1
- Requirements of EN 60204-1, under compliance with the safety instructions detailed in the operating instructions

IEC 61131

The HMI device satisfies the requirements and criteria conforming to IEC 61131-2, Programmable Controllers, Part 2: Equipment requirements and tests.

2.3 Operating safety

Standards

The HMI device complies with the following standards:

- EN 60204-1
Safety of Machinery – Electrical Equipment of Machines
- EN 61131-1 and EN 61131-2
Programmable Controllers
- The HMI device was tested for EMC in accordance with the following standards:
 - EN 50081-2, EMC – Unwanted emissions
 - EN 61000-6-2, Generic standard, Immunity, industrial environments
 - EN 61131-2, Programmable Controllers
- STOP button for fast machine stop
EN 60947-5-1:1997, K 2.2, Low-voltage Switchgear and Control Gear, Positive-Opening Contacts

EN 954-1 category 3 is achievable with an external monitoring device. Two potential-free switches for the connection of external I/O devices for a rated voltage of 24 V and max. current 500 mA (safety low voltage according to EN 61131-2 or EN 50178, equipment for power installations with electronic resources).
- Enabling device in accordance with EN 60204-1 in safety categories according to EN 954-1:1996, safety-related features of PLCs
 - EN 954-1, category 3 is achievable with an external monitoring device.
 - 2 parallel switched floating make contacts for connection of external I/O, rated voltage of 24 VDC (safety extra-low voltage in accordance with EN 61131-2 or EN 50178), maximum current of 400 mA.

If the HMI device is used in a system, the following standards are fulfilled:

- prEN 1921, Industrial automation systems – safety of integrated manufacturing systems
- EN 12417:2001, Machine tools – safety – machining centers
- UL 508, Industrial Control Equipment
- CSA C22.2 No.14, Industrial Control Equipment

2.4 Voltage supply

Safety specifications

 WARNING

The HMI device corresponds to protection class III according to EN 61131-2 or EN 50178. The 24 VDC supply must be isolated from touch-hazardous voltages, for example by means of a safety isolation transformer or similar equipment.

Protect the power supply circuit with a 3.15 A fuse.

Allowance should be made for the loss of voltage on the connecting cable during dimensional analysis of the supply!

2.5 Notes about Usage

Use in industry

The HMI device is designed for industrial use. For this reason, the following standards are met:

- Requirements for emissions EN 61000-6-4: 2007
- Requirements for interference immunity DIN EN 61000-6-2: 2005

Residential use

Note

The HMI device is not suitable for use in residential areas: If you use the HMI device in residential areas, the radio/TV reception may be impeded.

If the HMI device is used in a residential area, you must take measures to achieve Limit Class B conforming to EN 55011 for RF interference.

A suitable measure for achieving the required RF interference level for Limit Class B includes for example:

- Use of filters in electrical supply lines

Individual acceptance is required.

2.6 Risk analysis

Carrying out a risk analysis

The following standards must be used to perform the risk analysis:

- EN ISO 12100-1 and EN ISO 12100-2, General design guidelines for machines
- EN 1050 Risk Assessment for Machinery
- EN 954-1 Safety of Machinery

These considerations lead to a safety category (B, 1, 2, 3, 4) in accordance with EN 954-1 that ultimately dictates how the safety-related aspects of the system to be monitored are to be furnished.

The connection examples with three different monitoring devices show how the safety-related parts of the Mobile Panel 277 can achieve safety category 3 according to EN 954-1. Attention must be paid that the overall concept of the system is designed with this in mind.

2.7 Enabling Switch

Introduction

The enabling device comprises the two enabling buttons mounted on both sides of the Mobile Panel 277.

Numerically controlled machines and systems are equipped with the operating modes "Automatic mode" and "Special operation".

Safety is ensured in automatic mode by means of closed, isolating protective devices and/or with functional non-isolating protective devices that block access.

In special operation, safety has to be ensured in a different manner than in automatic mode. In special operation mode, the danger zones of the machine or system are entered, where controlled movements have to be possible.

Special operation

A reduced speed on the machine or in the system has to be specified for special operation based on the risk assessment. An action must be possible only when the enabling device is activated. The operator must have the necessary qualifications and be acquainted with the details of the intended application.

Safety instructions

The safety-related aspects of the velocity reduction control and those for the enabling device are designed in such a way that they satisfy the EN 954-1 safety category determined by the risk analysis.

Safety Category 3 in accordance with EN 954-1:1996 can be achieved by implementing the enabling devices with two circuits. The draft C standard for machine tools notes the following:

"Enabling devices can either be a 2-position command device in conjunction with a Stop device or a 3-position command device. The 3-position command device is preferable."

The operating principles of enabling devices are described in EN 60204. Through the findings from accident investigations and the existence of technical solutions, the 3-stage enabling button became state of the art. Positions 1 and 3 of the enabling button are Off functions. Only the middle position allows the enabling function. EN 60204-1:1997 is identical to IEC 60204-1, whereby the 3-stage enabling button is gaining international importance.

The Stop category of the enabling device must be selected on the basis of a risk assessment and correspond to a Category 0 or 1 Stop.

WARNING

Enabling buttons may only be used if the person activating them promptly recognizes a danger to personnel and can immediately take steps to avoid the danger!

Commands for unsafe conditions are not permitted to be issued with one enabling button alone. For this purpose, a secondary, conscious start command by means of a button on the Mobile Panel 277 is required. The only person allowed to remain in the danger zone is the person who is activating the enabling button.

In special operating modes, safety is achieved through use of the enabling button in combination with reduction in the velocity of the drives that are posing the danger.

Danger arising from improper use

To avoid danger arising from improper use of the enabling buttons, the following actions should be taken:

- Scan the enabling buttons.

The scan has to be carried out for the following processes:

- When the system being monitored is switched on
- When the operating mode changes from "Automatic" to "Manual mode"

In both cases, the enabling function may not be used.

- The enabling button must be released within a specified time frame and returned to the "Enable" setting.

Select the time frame according to the activity on the system being monitored.

2.8 STOP Button

Safety instructions

The STOP button on the HMI device brings about a safety-related stop of the system or machine in accordance with EN 60204-1:1997, Section 9.2.5.3. You have the option of implementing a Category 0, 1, or 2 Stop function in accordance with EN 60204-1: 1997, Section 9.2.2. The stop function category must be selected on the basis of a risk assessment.

The Stop function of the HMI device can, therefore, be used as a reliable machine stop as well as for looping in the Emergency Stop circuit of the system.

The signals of the STOP button are connected up differently in the connection box Plus and in the connection box Basic.

- Connection box Plus

With the connection box, the signals control the Stop or Emergency Stop circuits of the plant or machine. When the HMI device is not connected, the Stop or Emergency Stop circuit is closed.

- Connection box Basic

With the connection box Basic the signals of the Stop or Emergency Stop circuit are controlled via the STOP button. When the Mobile Panel 277 is not connected, the Stop or Emergency Stop circuits of the plant or machine are open.

Stop loop through

The Stop or Emergency Stop circuit of the system or machine is looped through the connection box Plus and not interrupted. The Stop or Emergency Stop circuit is interrupted in the following cases:

- The Stop button is pressed when the Mobile Panel 277 is connected.
- A Mobile Panel 277 with pressed STOP button is connected.

This functionality is only available in the connection box Plus.

 **WARNING**

HMI device with STOP button

If the HMI device is equipped with a STOP button and is not connected to the connection box, a Stop cannot be initiated using the HMI device. The STOP button of the HMI device is then ineffective!

Install stationary Emergency Stop buttons that are available at all times in the system.

Category 0 or 1 Stop

If a Category 0 or 1 Stop circuit is implemented, the stop function must be in effect regardless of the operating mode. A Category 0 Stop must have precedence. The release of a STOP button may not cause a hazardous situation (see also EN 60204:1997 chapter 9.2.5.3).

The stop function is not to be used as a replacement for safety equipment.

NOTICE
<p>Connection boxes in a system</p> <p>Install connection boxes of only one variant - in other words, only connection box Plus or connection box Basic.</p> <p>Mobile Panel 277 connected</p> <p>If the Mobile Panel 277 is connected to the connection box, the STOP button on the Mobile Panel 277 can trip if it falls, thus causing the system to come to a standstill.</p>

See also

STOP button on the connection box Plus (Page 111)

STOP button on the connection box Basic (Page 112)

2.9 Electromagnetic Compatibility

Introduction

The HMI device satisfies, among other things, the requirements of the EMC laws pertaining to the European domestic market.

EMC-compliant installation

The EMC-compliant installation of the connection box and the application of interference-proof cable is the basis for interference-free operation. The "Guidelines for interference-free installation of PLCs" description and the "PROFIBUS Networks" manual also apply to the installation of connection boxes.

Pulse-shaped interference

The following table shows the electromagnetic compatibility of modules with regard to pulse-shaped interference. This requires the HMI device to meet the specifications and directives for electrical installation.

Pulse-shaped interference	Test voltage	Degree of severity
Electrostatic discharge in accordance with IEC 61000-4-2	Air discharge: 8 kV Contact discharge: 6 kV	3
Bursts (high-speed transient interference) in accordance with IEC 61000-4-4	2 kV power supply cable 2 kV signal cable, > 30 m 1 kV signal cable, < 30 m	3

Pulse-shaped interference	Test voltage	Degree of severity
High-power surge pulses in accordance with IEC 61000-4-5, external protective circuit required (refer to S7-300 PLC, Installation, chapter "Lightning and overvoltage protection")		
<ul style="list-style-type: none"> Asymmetrical coupling 	2 kV power cable DC voltage with protective elements 2 kV signal/data cable, > 30 m, with protective elements as required	3
<ul style="list-style-type: none"> Symmetrical coupling 	1 kV power cable DC voltage with protective elements 1 KV signal cable, > 30 m, with protective elements as required	3

Sinusoidal interference

The following table shows the EMC behavior of the modules with respect to sinusoidal interference. This requires the HMI device to meet the specifications and directives for electrical installation.

Sinusoidal interference	Test values	Degree of severity
HF radiation (in electromagnetic fields) in accordance with IEC 61000-4-3	<ul style="list-style-type: none"> 80% amplitude modulation at 1 kHz with 10 V/m in the range of 80 MHz to 1 GHz with 3 V/m in the range 1.4 GHz to 2 GHz with 1 V/m the range 2 GHz to 2.7 GHz 10 V/m with 50 % pulse modulation at 900 MHz 10 V/m with 50 % pulse modulation at 1.89 GHz 	3
HF conductance on cables and cable shields in accordance with IEC 61000-4-6	Test voltage 10 V, with 80% amplitude modulation of 1 kHz in the 10 kHz to 80 MHz range	3

Emission of radio interference

The following table shows the unwanted emissions from electromagnetic fields in accordance with EN 55011, Limit Value Class A, Group 1, measured at a distance of 10 m.

From 30 to 230 MHz	< 40 dB (V/m) quasi-peak
From 230 to 1000 MHz	< 47 dB (V/m) quasi-peak

Additional measures

Before you connect an HMI device to the public network, ensure that it is compliant with Limit Value Class B in accordance with EN 55022.

2.10 Transport and Storage Conditions

Mechanical and climatic transport and storage conditions

The transportation and storage conditions of this HMI device exceed requirements in accordance with IEC 61131-2. The following specifications apply to the transportation and storage of an HMI device in its original packaging.

The climatic conditions comply with the following standards:

- IEC 60721-3-3, Class 3K7 for storage
- IEC 60721-3-2, Class 2K4 for transport

The mechanical conditions are compliant with IEC 60721-3-2, Class 2M2.

The following table shows the transportation and storage conditions for the HMI device.

Type of condition	Permitted range
Drop test (in transport package)	≤ 1 m
Temperature	From –20 to +60 °C
Atmospheric pressure	From 1080 hPa to 660 hPa, corresponds to an elevation –1000 to 3,500 m
Relative humidity	From 10 % to 90 %, without condensation
Sinusoidal vibration in accordance with IEC 60068-2-6	5 Hz to 8.4 Hz: 3.5 mm 8.4 to 500 Hz: 9.8 m/s ²
Shock in accordance with IEC 60068-2-29	250 m/s ² , 6 ms, 1000 shocks

The following table shows the transportation and storage conditions for the terminal device.

Type of condition	Permitted range
Drop test (in transport package)	≤ 1 m
Temperature	From –20 to +70 °C
Atmospheric pressure	From 1080 hPa to 660 hPa, corresponds to an elevation –1000 to 3,500 m
Relative humidity	From 35 % to 85 %, without condensation
Sinusoidal vibration in accordance with IEC 60068-2-6	5 Hz to 8.4 Hz: 3.5 mm 8.4 to 500 Hz: 9.8 m/s ²
Shock in accordance with IEC 60068-2-29	250 m/s ² , 6 ms, 1000 shocks

NOTICE

In the following cases, ensure that no moisture can settle on or in the HMI device (dew):

- Transportation of the HMI device in low temperatures
- Under extreme temperature variations

The HMI device must have acquired room temperature before it is put into operation. Do not expose the HMI device to direct radiation from a heater in order to warm it up. If dewing has developed, wait approximately four hours until the HMI device has dried completely before switching it on.

The following points must be adhered to in order to ensure a fault-free and safe operation of the HMI device:

- Proper transportation and storage
- Proper installation and mounting
- Careful operation and maintenance

The warranty for the HMI device will be deemed void if these stipulations are not heeded.

Planning application

3.1 Notes about Usage

Mechanical and climatic conditions of use

The HMI device is designed for use in a location protected from the effects of the weather. The conditions of use are compliant with requirements to DIN IEC 60721-3-3:

- Class 3M3 (mechanical requirements)
- Class 3K3 (climatic requirements)

Use with additional measures

Examples of applications where the use of the HMI device requires additional measures:

- In locations with a high degree of ionizing radiation
- In locations with difficult operating conditions - for example due to:
 - Corrosive vapors, gases, oils or chemicals
 - Electrical or magnetic fields of high intensity
- In systems that require special monitoring - for example:
 - Elevators
 - Systems in especially hazardous rooms

Mechanical ambient conditions

The following table shows the mechanical ambient conditions for the HMI device in the form of sinusoidal vibration.

Frequency band in Hz	Constant	Occasional
$10 \leq f \leq 58$	Amplitude 0,0375 mm	Amplitude 0.075 mm
$58 \leq f \leq 150$	Constant acceleration 0.5 g	Constant acceleration 1 g

Reducing vibrations

If the HMI device is subjected to greater shocks or vibrations, you must take appropriate measures to reduce acceleration or amplitudes.

We recommend fitting the HMI device to vibration-absorbent material (on metal shock absorbers, for example).

Testing mechanical ambient conditions

The following table provides information on the type and scope of tests for mechanical ambient conditions.

Tested for	Test standard	Comments
Vibrations	Vibration test in accordance with IEC 60068, part 2–6 (sinusoidal)	Type of vibration: Transitional rate of the frequency: 1 octave/minute. 10 ≤ f ≤ 58, constant amplitude 0.075 mm 58 ≤ f ≤ 150, Constant acceleration 1 g Vibration duration: 10 frequency cycles per axis in each of the three mutually vertical axes.
Shock	Shock testing in accordance with IEC 60068, Part 2 –29	Type of shock: half-sine Shock intensity: Peak value 15 g, duration 11 ms Direction of impact: 3 shocks in ± directions in each of the three mutually vertical axes
Falling	Drop test in accordance with EN 60068-2-32	

Climatic ambient conditions for the mobile panel

The following table shows the permitted climatic ambient conditions for use of the mobile panel.

Ambient conditions	Permitted range	Comments
Temperature • Operation • Storage/Transport	• From 0 °C to 40 °C • From –20 °C to 60 °C	See the "Mounting positions and type of fixation" section
Relative humidity	10 to 90 %, without condensation	Corresponds to relative humidity, load degree 2 in accordance with IEC 61131, part 2
Atmospheric pressure	1080 hPa to 795 hPa	Corresponds to an elevation of –1,000 to 2,000 m
Pollutant concentration	SO ₂ : < 0,5 ppm; Relative humidity < 60 %, no condensation	Test: 10 cm ³ /m ³ ; 10 days
	H ₂ S: < 0.1 ppm; Relative humidity < 60 %, no condensation	Test: 1 cm ³ /m ³ ; 10 days

Climatic ambient conditions for the connection box

The following table shows the permitted climatic ambient conditions for use of the connection box.

Ambient conditions	Permitted range	Comments
Temperature • Operation • Storage/Transport	<ul style="list-style-type: none"> From 0 °C to 50 °C From -20 °C to 70 °C 	See the "Mounting positions and type of fixation" section
Relative humidity • Operation • Storage/Transport	<ul style="list-style-type: none"> 35 % to 85 % 35 % to 85 % 	Without condensation, corresponds to a relative humidity, stress class 2 in accordance with IEC 61131, part 2
Atmospheric pressure	1080 hPa to 795 hPa	Corresponds to an elevation of -1,000 to 2,000 m
Pollutant concentration	SO ₂ : < 0,5 ppm; Relative humidity < 60 %, no condensation	Test: 10 cm ³ /m ³ ; 10 days
	H ₂ S: < 0.1 ppm; Relative humidity < 60 %, no condensation	Test: 1 cm ³ /m ³ ; 10 days

3.2 Mounting positions and type of fixation

Mounting position

The wall holder is designed for vertical mounting.

The connection box is designed for surface mounting independently of cabinets or control panels.

The connection box is self-ventilated and is approved for all mounting positions. Note that the guaranteed protection rating is only ensured if the connecting cable or the dummy cap is plugged into the connection box.

3.3 Preparing for mounting

Choose the mounting location for the wall holder

Observe the following points when selecting the mounting location:

- Position the wall holder so that the display of the hooked-in HMI device is not exposed to direct sunlight.
- Position the wall holder so that the HMI device can be ergonomically inserted by the user. Choose a suitable mounting height.

Maintaining clearances

The following clearances are required around the wall holder:

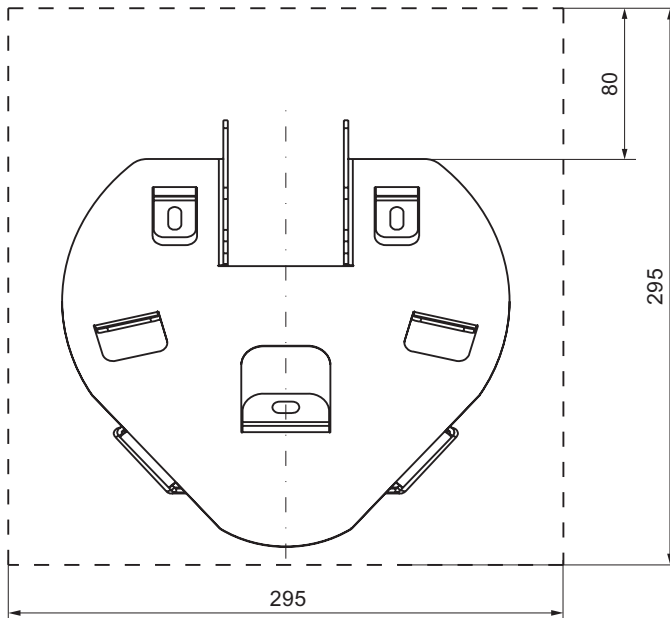

The following clearances are required around the connection box DP:

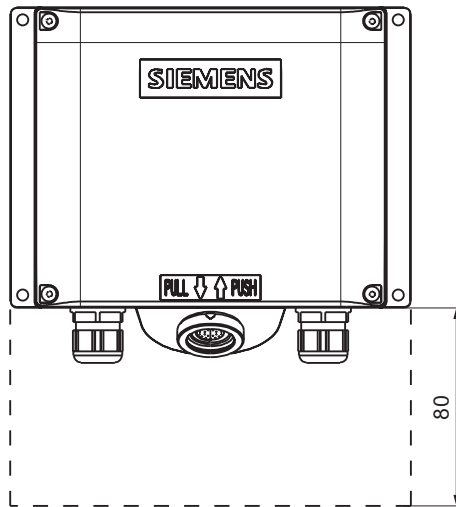

The following clearances are required around the connection box PN:

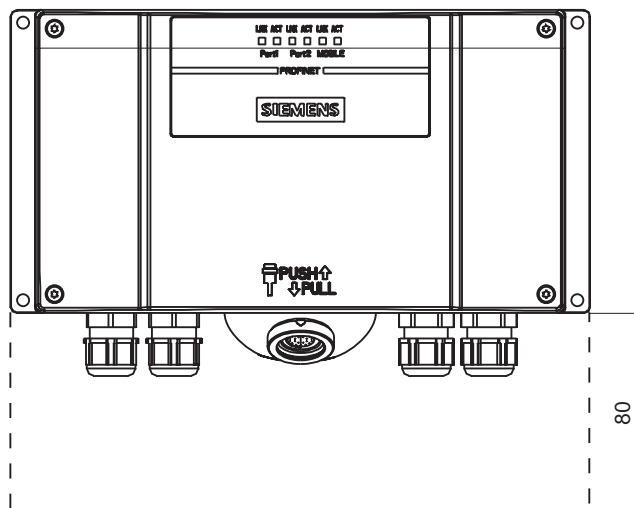

3.4 Specifications for Insulation Tests, Protection Class and Degree of Protection

Test voltages

Insulation strength is demonstrated in the type test with the following test voltages in accordance with IEC 61131-2:

Circuits with a nominal voltage of U_n to other circuits or ground	Test voltage
< 50 V	500 VDC

Protection class

Protection Class I in accordance with IEC 60536, i.e. equipotential bonding conductor to profile rail required!

Protection against foreign objects and water

Degree of protection in accordance with IEC 60529	Description
Front panel and rear panel	In installed status: <ul style="list-style-type: none">• IP65

3.5 Rated voltages

The following table shows the rated voltage and the corresponding tolerance range.

Nominal voltage	Tolerance range
+24 VDC	20.4 V to 28.8 V (-15 %, +20 %)

Installation and connection

4.1 Checking the Package Contents

Check the package contents for visible signs of transport damage and for completeness.

NOTICE
Do not install parts damaged during shipment. In the case of damaged parts, contact your Siemens representative.

The documentation belongs to the HMI device and is required for subsequent commissioning. Keep all provided documentation in a safe place for the entire service life of the HMI device. You must pass on the enclosed documentation to any subsequent owner or user of the HMI device. Make sure that every supplement to the documentation that you receive is stored together with the operating instructions.

4.2 Mounting the Connection Box and Wall Holder

Requirements

The following are required for mounting:

- Three M5 cylinder head screws for the wall holder of the HMI device
- Four M4 cylinder head screws for the connection box

If the HMI device is to be operated while hooked into the wall holder, ensure that the connecting cable is sufficiently long.

Procedure for mounting the wall holder

NOTICE
In order to ensure that the HMI device can be hooked in securely, select a vertical surface or one inclined slightly to the rear as the mounting surface.
For HMI device with STOP button: The HMI device can fall down if it is not securely hooked in. In the process the STOP button might be triggered unintentionally, thus causing the machine or system to stop.

Note

Positioning

A position at eye level is recommended. This enables the Mobile Panel 277 to be operated when it is hooked into the wall holder.

Proceed as follows:

1. Select a position for the wall holder that is easy and safe to reach.
2. Place the wall holder from the front onto the mounting surface.
3. Mark the mounting holes with a marking tool.
4. Drill three through holes or three threaded holes M5.
5. Attach the wall holder.

Procedure for mounting the connection box

Note

Length of the connecting cable

Allow for the maximum length of the connecting cable when selecting the position for the connection box.

Proceed as follows:

1. Select a position for the connection box that is easy and safe to reach.
2. Place the connection box from the front onto the mounting surface.
3. Mark the mounting holes with a marking tool.
4. Drill four through holes or four threaded holes M4.

NOTICE
Permissible torque
The connection box housing is made of plastic. Do not exceed 0.4 to 0.5 Nm of torque when tightening the screws.
If the screws are tightened more than 20 times, there is risk of damage to the threads.

5. Attach the connection box.

See also

Mounting positions and type of fixation (Page 47)

4.3 Electrical Installation

Electrical connections

The electrical installation comprises the components:

- Mobile Panel 277
- Connection box

You can connect the following devices or HMI devices to these components:

Device/Control element	Mobile Panel 277	Connection box
Configuring PC	Yes	Yes
Printer	–	Yes ¹⁾
PLC	–	Yes
Supply voltage	–	Yes
Connection to Stop circuit	–	Yes
Monitoring signal of the STOP button	–	Yes
Connection to enable circuit	–	Yes
Cable for input bit for connection detection	–	Yes

¹⁾ Applies to the connection of a network printer to Mobile Panel 277 via the connection box PN

4.4 Connecting the connection box

4.4.1 Overview

Requirements

- The connection box is mounted in accordance with the specifications of these operating instructions.
- Only shielded standard cables may be used.

NOTICE

Permitted length of the connecting cable

Do not exceed the permitted cable length of 30 m as you will otherwise risk functional errors.

Always maintain a maximum length of 30 m for the connecting cable. This information concerns the length of the cable between the connection box and the HMI device.

For additional information, refer to the Internet at:

["http://mall.automation.siemens.com"](http://mall.automation.siemens.com)

Connection sequence

Connect the connection box in the following sequence:

1. Equipotential bonding
2. Supply voltage
3. PLC / configuring PC if needed

NOTICE
Maintaining the connection sequence You risk damage to the connection box if you ignore the proper connection sequence. Always adhere to the proper sequence when connecting the connection box.

4.4.2 Opening and closing the connection box

Follow the instructions below before opening the connection box PN Plus:

CAUTION
Short circuit in the connection box A short-circuit in the connection box PN Plus can lead to malfunction of the Mobile Panel 277. Take care when working on the opened connection box, that conducting materials, such as cable remains, do not come into contact with the electrical circuits.
ESD When working in the open housing, ensure that current-carrying conductors do not come into contact with electrical circuits. Note the ESD instructions.

Requirements

- Torx screwdriver, Size 10

Procedure



- ① Screws
- ② Cover

Proceed as follows:

1. Loosen the four marked screws.
2. Remove the screws and the cover.

Protective cover

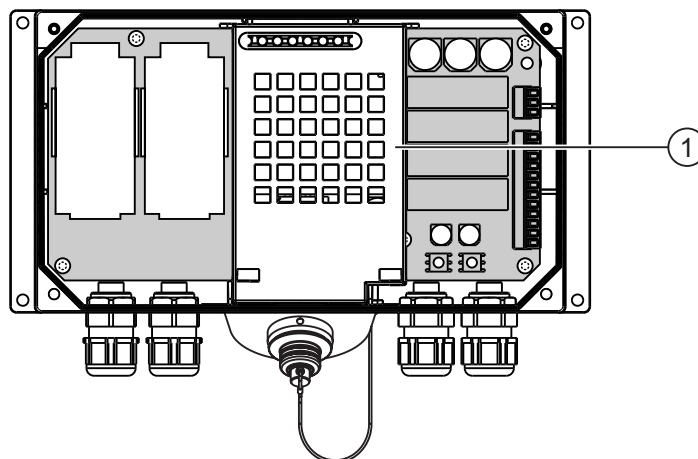

- ① Protective cover

Note

Protective cover

Do not remove the protective cover. Otherwise there is a risk that the electronics of the connection box will be damaged or destroyed.

Notes for closing

NOTICE
Permissible torque The connection box housing is made of plastic. Therefore, the mounting hole threads cannot handle the same amount of stress as a comparable metallic housing. Do not exceed 0.4 to 0.5 Nm of torque when tightening the screws. If the screws are tightened more than 20 times, there is risk of damage to the threads.
Degree of protection not fulfilled When assembling the unit, be sure to fit plugs to all unused screw glands and to insert the appropriate seal for the cover. Otherwise degree of protection IP65 is not ensured.

4.4.3 Setting the box ID at the connection box

Introduction

You can set a unique box ID for station identification in each connection box. If configured correspondingly, the box ID can be read out of the HMI device and be transmitted to the PLC.

Rotary encoder switch

The following figures show the position of both rotary encoder switches in the connection box DP and the connection box PN.

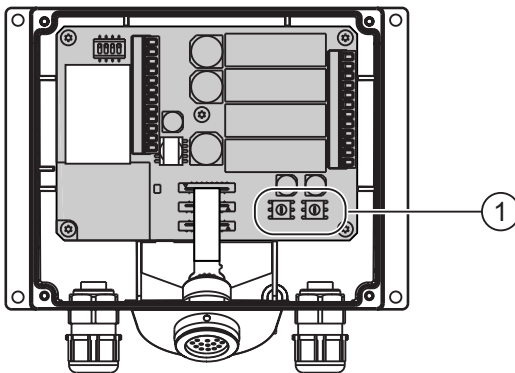

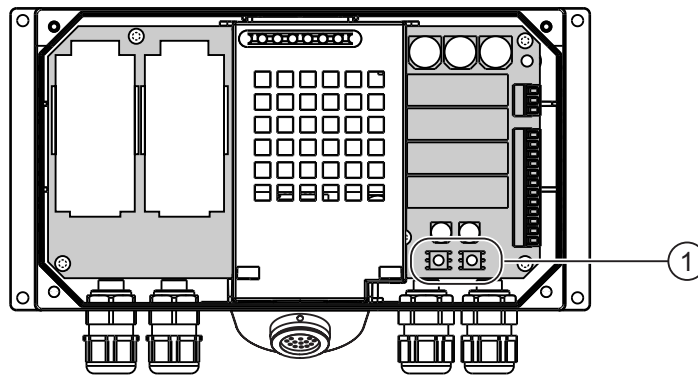

① Rotary encoder switch

Example for setting the box ID

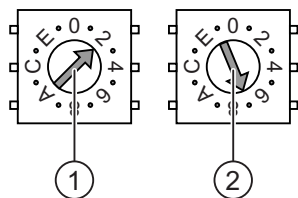

- ① Rotary encoding switch for more significant bits
- ② Rotary encoding switch for less significant bits

The figure shows the set box ID 27H, for example 39, in decimal format.

Procedure

Proceed as follows:

1. Open the connection box.
2. Set the Box ID with the help of a screwdriver.
The input is in hexadecimal format. Values between 0 and 255 can be set in decimal format.
3. Close the connection box.

Result

The box ID is set.

4.4.4 Stripping the Insulation of Cables

Stripping insulation

The following figure shows how to strip an MPI/PROFIBUS DP cable.



The following figure shows you how to strip a PROFINET cable.



Note

Use a stripping tool from the online catalog under "<http://mall.automation.siemens.com>" for quick stripping to the proper length.

4.4.5 Connecting the equipotential bonding circuit

Potential differences

Differences in potential between spatially separated system parts can lead to high equalizing currents via the data cables and therefore to the destruction of their ports. This situation may arise if the cable shielding is terminated at both ends and grounded at different system parts.

Differences in potential may develop when a system is connected to different mains supplies.

General requirements for equipotential bonding

Differences in potential must be reduced by means of equipotential bonding in order to ensure trouble-free operation of the relevant components of the electronic system. The following must therefore be observed when installing the equipotential bonding circuit:

- The effectiveness of equipotential bonding increases as the impedance of the equipotential bonding conductor decreases or as its cross-section increases.
- If two parts of the system are connected to each other by means of shielded data cables, and its shielding is connected at both ends with the grounding / protective grounding conductor, then the impedance of the additionally-laid equipotential bonding may amount to a maximum of 10% of the screened impedance.
- The cross-section of a selected equipotential bonding conductor must be capable of handling the maximum equalizing current. Between switching cabinets, equipotential bonding conductors as detailed in the "Guidelines for interference-free installation of PLCs" description and the "PROFIBUS networks" manual have proven themselves reliable in practice.
- Use equipotential bonding conductors made of copper or galvanized steel. Establish a large surface contact between the equipotential bonding conductors and the grounding/protective conductor and protect these from corrosion.
- Clamp the shielding of the data cable on the HMI device flush and near the equipotential busbar using suitable cable clamps.
- Route the equipotential bonding conductor and data cables in parallel with minimum clearance between them.

NOTICE
Equipotential bonding conductor Cable shielding is not suitable for equipotential bonding. Always use the prescribed equipotential bonding conductors. When installing MPI and PROFIBUS DP networks, always use cables with an adequate cross-section. Otherwise there is a risk that interface components will be damaged or destroyed.

Connection graphic

The following figure shows how to connect the equipotential bonding conductor to the connection box PN Plus.

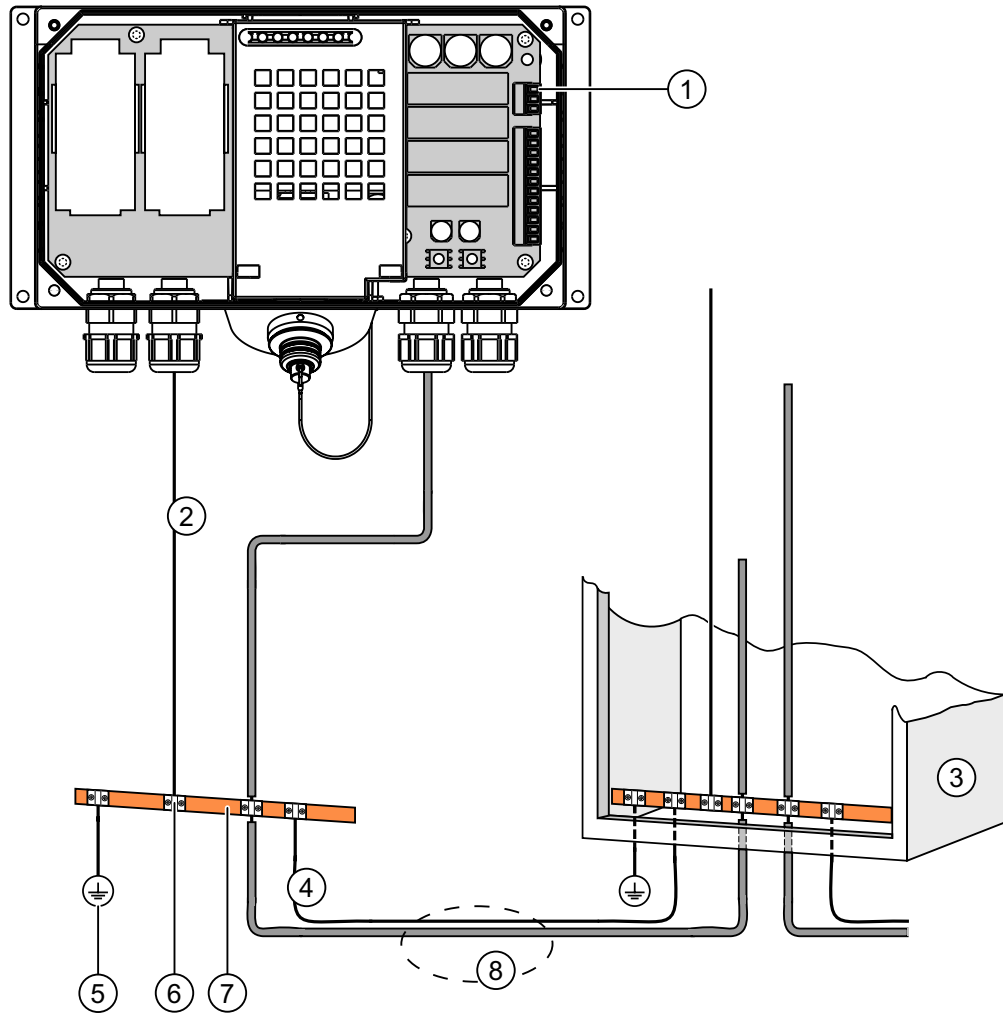

- ① PE connection on the connection box (terminal strip 1, pin 1)
- ② Equipotential bonding conductor cross-section: 2.5 mm²
- ③ Switching cabinet
- ④ Equipotential bonding conductor cross-section: min. 16 mm²
- ⑤ Ground connection
- ⑥ Cable clip
- ⑦ Equipotential busbar
- ⑧ Parallel routing of the equipotential bonding conductor and data cable

4.4.6 Connecting the PLC

Introduction

Always use the approved cables to connect a SIMATIC S7 PLC. Note also the maximum permissible cable lengths for the process interface. Standard cables are available for the connection. For additional information, refer to the Internet at "<http://mall.automation.siemens.com>".

Configuration diagram – Connecting a PLC to a connection box DP

The figure below shows how to connect the PLC to the connection box DP and to a Mobile Panel 277 8".

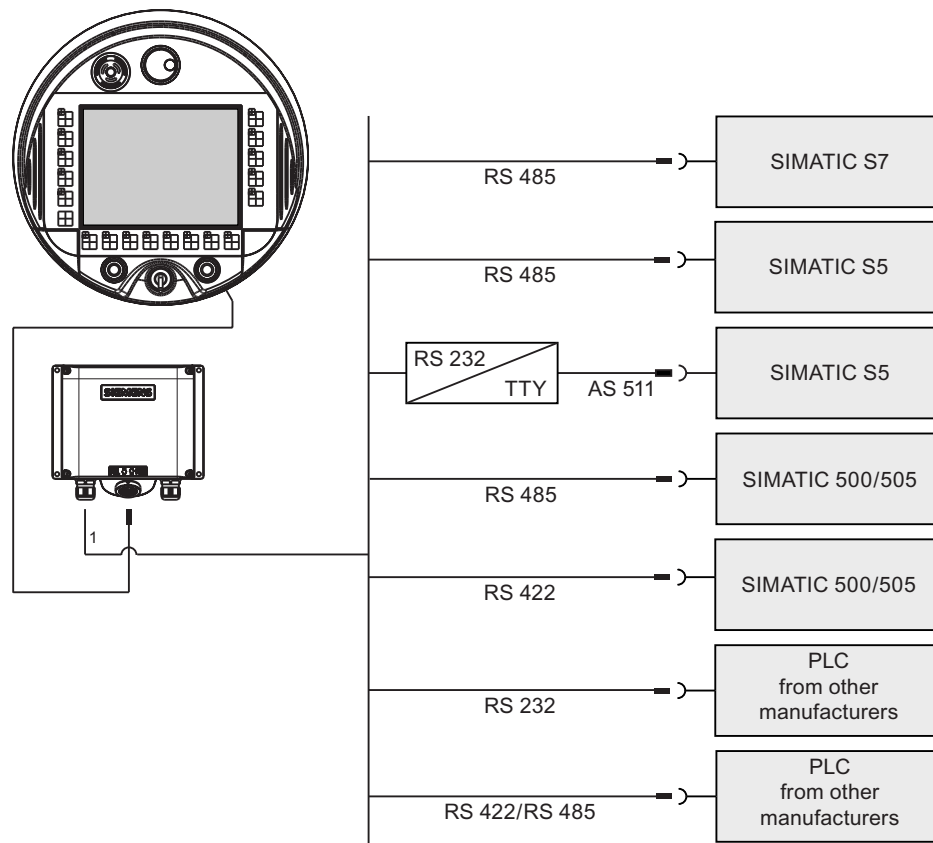

- 1 When operated on port IF1, RS 232 and RS 422/485 may only be connected alternatively. IF1 is located on terminal strip 1 of the connection box DP.

Use only the cables approved for that purpose to connect to a SIMATIC S7 PLC.

Configure the port IF1 on the connection box DP

The IF1 port can be configured using the DIL switch.
 The figure below shows the position of the DIL switch.

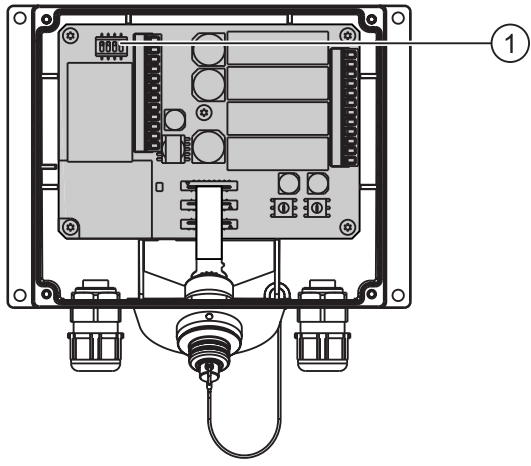

① DIL switch

Note

Note the diagrams of the DIL switch settings on the inside of the cover.

The following table shows the settings of the DIL switch. The transmitting and receiving direction is switched internally with the RTS signal.

Communication	Switch setting	Meaning
RS 485	1 2 3 4 ON	Connection box not last node in the data network, terminal resistance not activated Corresponds to default setting.
RS 485	1 2 3 4 ON	Connection box last node in the data network, terminal resistance activated
RS 232/RS 422	1 2 3 4 ON	For third-party PLCs

Configuration diagram – Connecting a PLC to a connection box PN

The figure below shows how to connect the PLC to the connection box DP PN and to a Mobile Panel 277 8".

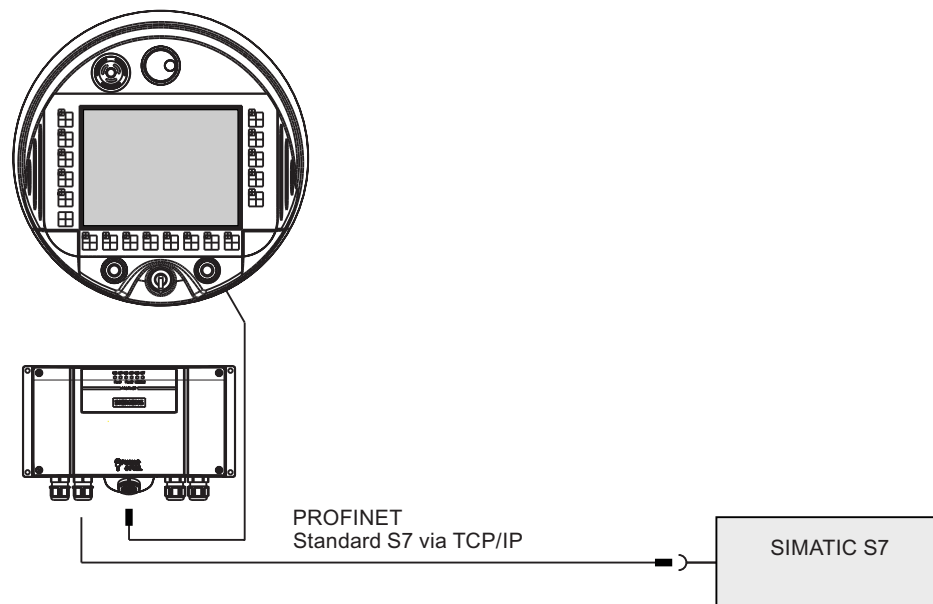

NOTICE

Damage to the HMI device

Only connect the HMI device to public Ethernet networks using a switch or comparable device.

PROFINET IO communication

For instructions regarding the installation of PROFINET networks, please refer to the PROFINET system description manual.

4.4.7 Connecting a Configuring PC

Introduction

Standard cables are available for the connections shown. For additional information, refer to the Internet at "<http://mall.automation.siemens.com>".

Configuration diagram

The following figure shows the connection between a connection box and a configuring PC via PROFIBUS DP.

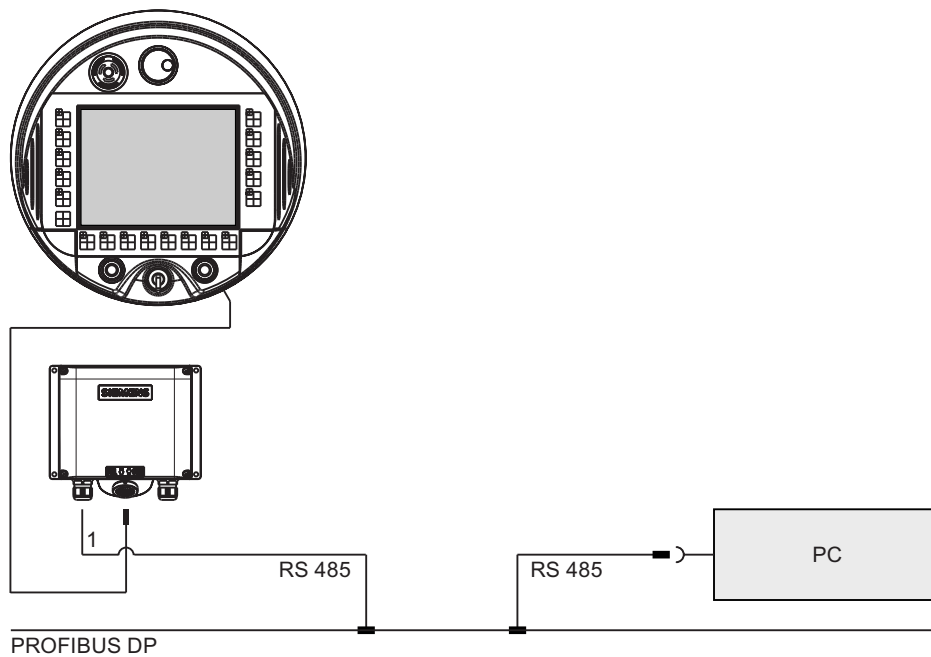

- 1 When operated on port IF1, RS 232 and RS 422/485 may only be connected alternatively. IF1 is located on terminal strip 1 of the connection box DP.

The following figure shows the connection between a connection box and a configuring PC via PROFINET.

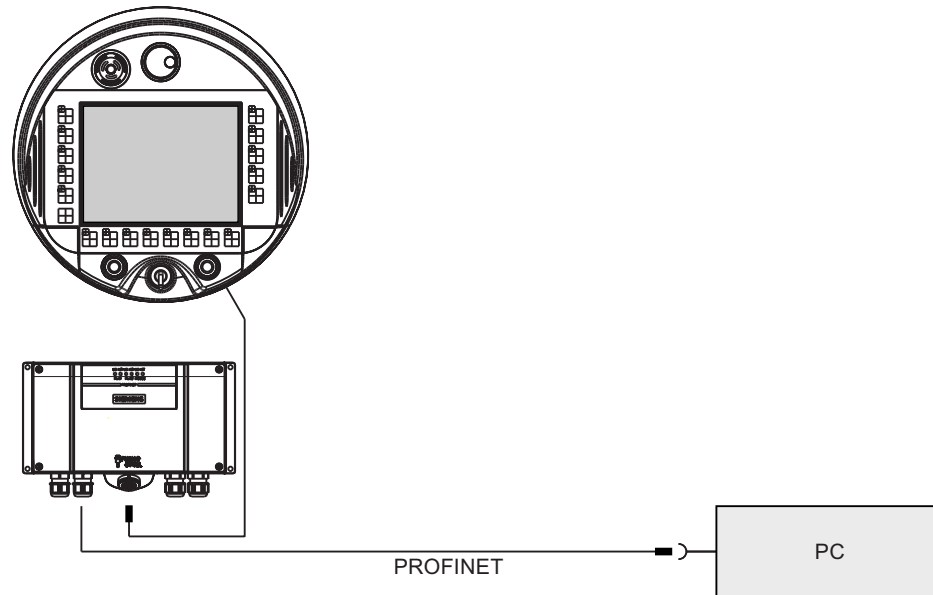

4.4.8 Connecting a printer to a connection box PN

Introduction

You can connect a printer to the connection box PN via PROFINET.

The current list of printers recommended for use with the HMI devices is available on the Internet at "<http://support.automation.siemens.com/WW/view/en/11376409>".

Observe the supplied printer documentation when you connect the printer.

Configuration diagram

The following figure shows the connection between the connection box PN and a printer.

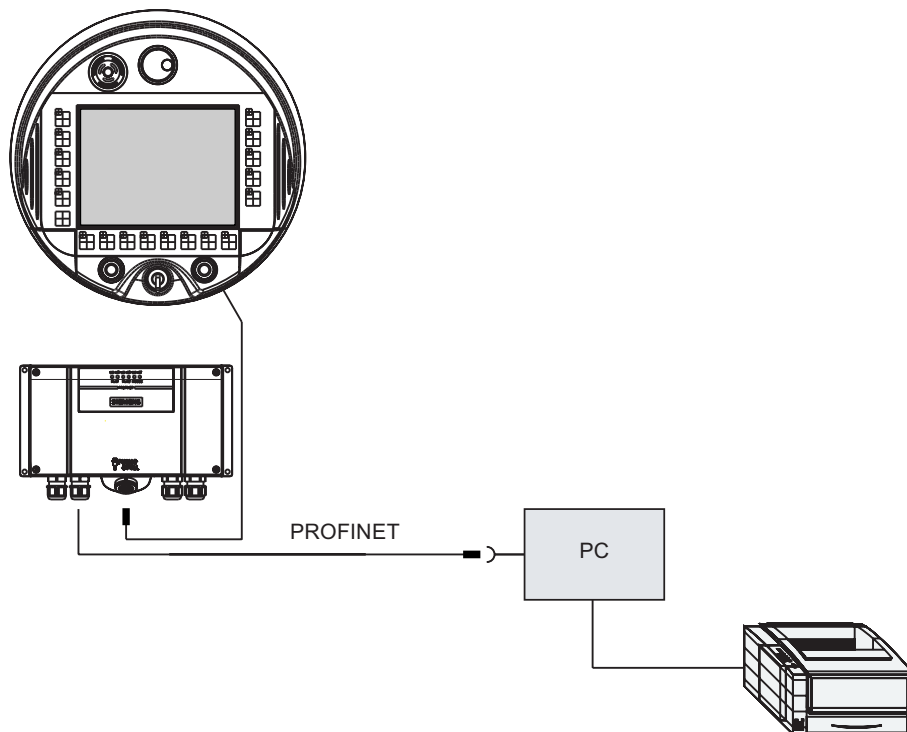

4.4.9 Connecting the Power Supply

Introduction

The supply voltage for the HMI device is connected to a terminal strip in the connection box. The terminal block is designed for cables with a maximum cross-section of 1.5 mm².

Connect the protective conductor connection of the connection box with the cabinet casing or equipotential bonding.

Note

Reverse polarity protection

The connection box has reverse polarity protection.

Connection graphic

The following figure shows the connection of the power supply to the connection box DP.

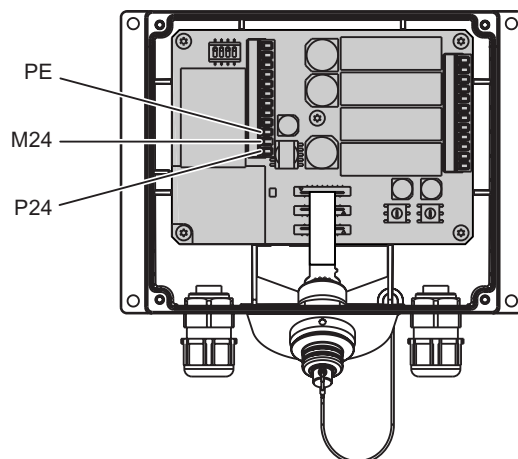

The following figure shows the connection of the power supply to the connection box PN.

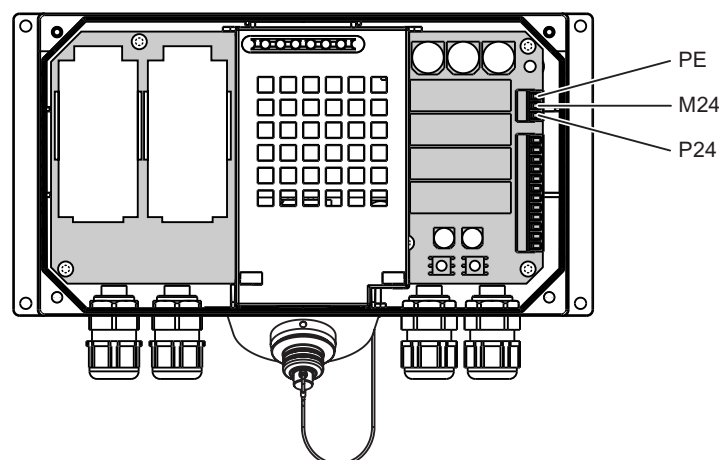

Meaning of the abbreviations used in the figures:

- PE stands for protective conductor.
- M24 stands for ground.
- P24 stands for +24 VDC.

Please refer to the technical data for the supply voltage requirements.

 WARNING
24 VDC supply Personal injury and equipment damage can occur. Configure the 24 VDC supply for the Mobile Panel 277 correctly, otherwise components of your automation system can be damaged and persons may be injured. Use only voltage generated as safety extra-low voltage (SELV) for the 24V DC supply of the Mobile Panel 277.

CAUTION
Safety isolation Use only power supply units with safety isolation complying with IEC 60364-4-41 or HD 384.04.41 (VDE 0100, Part 410), for example according to the PELV standard, for the 24 VDC supply. The supply voltage must be within the specified voltage range. Malfunctions in the HMI device may otherwise result. Applies to floating system design: Connect the connection for GND 24 V from the 24 V power supply output to equipotential bonding for uniform reference potential.

4.5 Connecting Mobile Panel 277

4.5.1 Connecting the HMI device

Connecting the cables

When connecting the cables, ensure that the contact pins are not bent. Secure the connectors with screws.

The pin assignment of the ports is described in the technical specifications.

4.5.2 Opening and Closing the Terminal Compartment

Introduction

Observe the following information before you open the connection box:

CAUTION
Malfunctions If the HMI device is placed facing down on its front, the STOP button can be activated. Other operating elements (key-operated switch, illuminated pushbutton) can be activated unintentionally, thus causing malfunctions. When you open the terminal compartment, you must remove the connecting cable belonging to the Mobile Panel 277 from the connection box.
Mobile panel with rechargeable battery Note that a mobile panel with inserted rechargeable battery will not switch off before approx. 10 minutes have elapsed if a project is running.
ESD guideline Note the ESD instructions.

Note

Pay attention to cleanliness. Foreign bodies or liquids must not come into contact with the printed circuit board or penetrate the inside of the HMI device.

Place the HMI device with the front side facing down on a flat, clean surface to protect against damage.

Requirements

Cross-head screwdriver, size 2

Procedure

This section describes how to open and close the connection box based on the example of Mobile Panel 277 8".

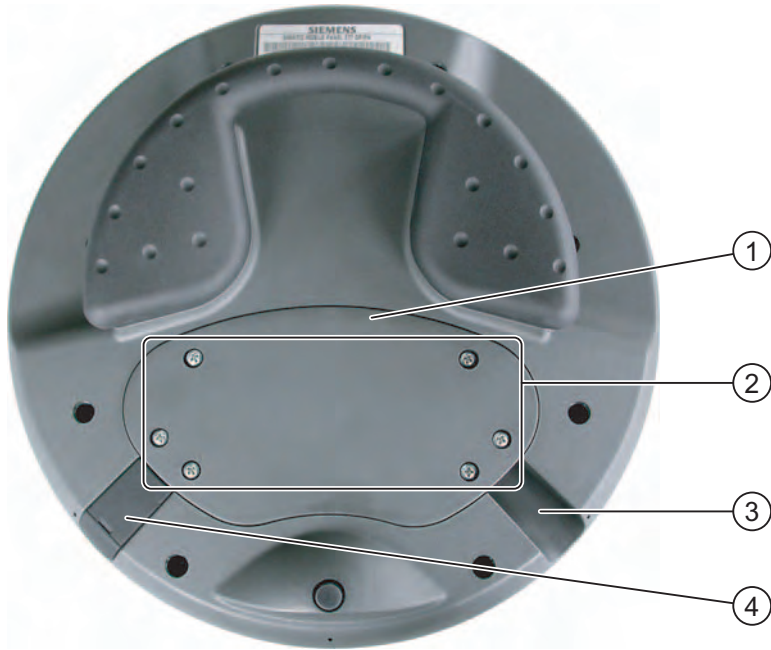

- ① Cover
- ② Screws on the cover
- ③ Cable inlet
- ④ Plugs

Proceed as follows:

1. Unscrew the six screws approximately 1 cm out of the cover.

The cover is designed in such a way that the screws are retained. Therefore, do not screw the screws out further than 1 cm. The screws can then be removed together with the cover.

2. Put the cover with the screws to one side.

Note on closing:

1. Place the sealing plugs into the cable inlets which are not used.

Notes for closing

NOTICE
Permissible torque The housing of the Mobile Panel 277 is made of plastic. Therefore, the mounting hole threads cannot handle the same amount of stress as a comparable metallic housing. Do not exceed 0.4 to 0.5 Nm of torque when tightening the screws. If the screws are tightened more than 20 times, there is risk of damage to the threads.
IP65 degree of protection Ensure that the seal belonging to the cover is present during mounting. When you have finished working on the connections, check to make sure that the unused threaded cable entry holes are fitted with rubber plugs. Otherwise degree of protection IP65 is not ensured.

4.5.3 Mobile Panel 277 ports

For reasons of clarity, the following figures depict the terminal compartment without the Velcro strip for fastening the memory card.

The following figure shows the port area for the data network.

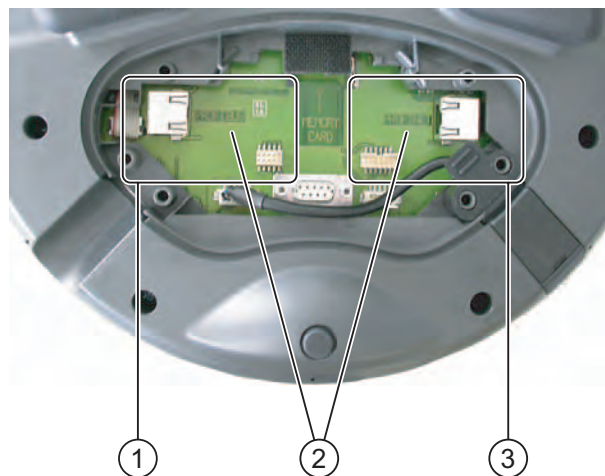

- ① Ports for PROFIBUS DP
- ② Port designation
- ③ PROFINET ports

The following figure shows the available ports on the Mobile Panel 277.

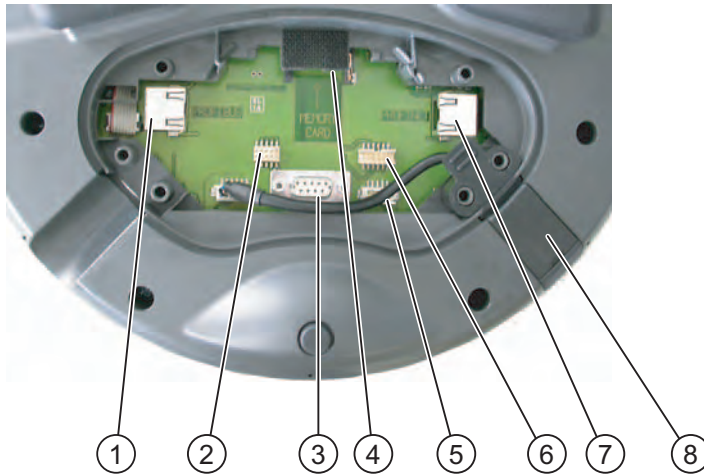

- ① RJ45 socket for the connecting cable DP
- ② Post connector, 10-pole for the connecting cable DP
- ③ RS 485 port (IF 2)
- ④ Slot for a memory card
- ⑤ Connection for the rechargeable battery
- ⑥ Post connector, 12-pole for the connecting cable PN
- ⑦ RJ45 socket for connection cable PN
- ⑧ USB socket

CAUTION

RJ45 socket

Only use the RJ45 socket for the connection box's connecting cable.

Please note when connecting, that the functional efficiency of the Mobile Panel 277 is only ensured by means of the connecting cable's RJ45 socket. Note the warning signs in the opened Mobile Panel 277.

USB socket

The USB socket is depicted as a sealing plug. You can deploy the USB socket in either of the two cable inlets.



- ① USB socket
- ② Cap
- ③ Cable inlet

CAUTION

Degree of protection

Degree of protection IP65 is only ensured if the cap on the USB socket is plugged and sealed tight.

Connection sequence

Connect the connecting cable's connector in the following sequence:

1. Place the USB socket in the other cable inlet if necessary.
2. Plug in the connecting cable.
3. Connect the connector for the power supply.
4. Connect the connector for the data communication.

4.5.4 Connecting a Configuring PC

Requirements

- The Mobile Panel 277 is connected to the connection box.
- Rule for the connection via RS 485

The cover of the terminal compartment on the Mobile Panel 277 is removed.

NOTICE
Degree of protection IP65 not met
It is not possible to fasten the cover of the connection box if a configuration PC is connected directly to Mobile Panel 277 via RS 485.
Only connect a configuration PC directly with Mobile Panel 277 if ambient conditions do not demand the degree of protection IP65.

Configuration diagram

The following figure shows the connection of the HMI device with a configuration PC via RS 485 and USB. The following data can be exchanged between the HMI device and a configuration PC:

- Project
- HMI device image

If there is no operable HMI device image on the HMI device or none at all, you can update the operating system by restoring the factory settings. See chapter Reset to factory settings (Page 179).

Use only the original PC/PPI cable for the update.

- Additional project data

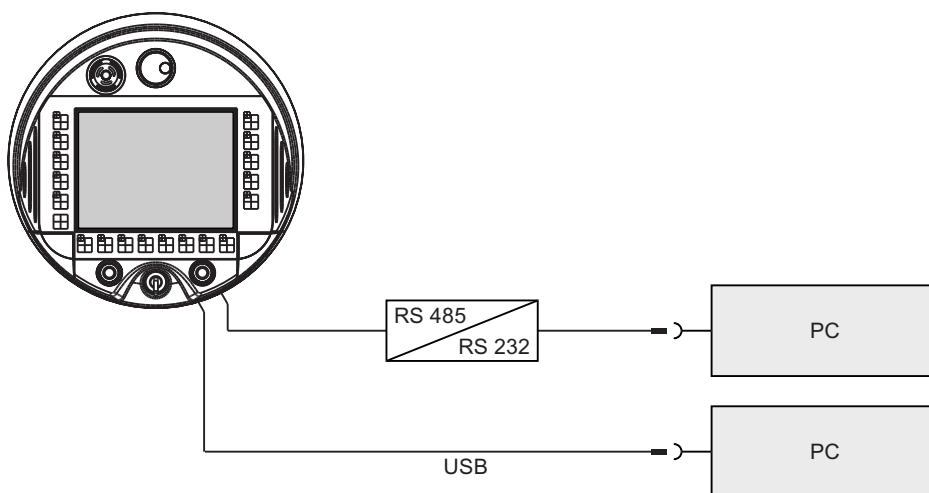

A Siemens AG tested and released PC/PPI cable should be used to convert from RS 232 to RS 485. See chapter "PC/PPI cable" (Page 26).

USB connection

Observe the following information when connecting a USB device:

NOTICE

Adhere to the USB connection sequence

You will not be able to transfer a project to the HMI device if you do not adhere to the connection sequence.

Observe the following sequence when connecting by USB:

1. HMI device
2. PC

USB Host-to-Host cable

You will not be able to transfer a project to the HMI device if you use driver for the USB host-to-host cable.

Use only the driver that is included with WinCC flexible for the USB host-to-host cable.

Note

A USB/PPI patch cable V 5 or higher is required for operation at higher bit rates. The version code is printed on the cable (e.g., "E stand 5" corresponds to version 5).

4.5.5 Connecting the Connecting Cable

Introduction

The connection cable can be connected to the connection box with the help of a connector (metallic push-pull circular connector). The connector is coded to prevent faulty insertion.



- ① Positioning mark
- ② Outer sleeve

Observe the following when connecting the connection cable:

- The HMI device is switched off
- The HMI device is in Transfer mode

Having connected the connection cable, the following is activated immediately:

- Runtime on the HMI device
- The display
- The touch
- The membrane keyboard
- All other operator controls and software-independent enabling and emergency off buttons

CAUTION
Connecting HMI devices with activated buttons When you connect an HMI device to the connection box, activated operator controls are immediately evaluated. This can cause unintentional responses. Check the position of the operator controls and do not activate any operator controls before or during the connection.
Reconnecting the connection cable The behavior of the HMI device after a reconnection is different to the behavior after a restart. Depending on the configuration in the system, this different behavior can bring about undesirable situations. Check to see if it makes sense to adapt the project and instruct your operators, e.g. in the evaluation of the startup bit.

Procedure for inserting the connector

Proceed as follows:

1. Align the red positioning mark of the connector ① with the positioning mark of the socket of the connection box.
2. Insert the connector into the socket of the connection box.

Do not tilt the connector when inserting it. The connector is locked after you have inserted it. Unintentional removal of the connecting cable is now safely prevented.

Procedure for removing the connector

Proceed as follows:

1. Pull back the outer bushing ②.

The connector lock is released when you slide back the bushing. You can now remove the connection cable. Do not tilt the connector when removing it.

If you do not intend to use the Mobile Panel 277 with a different connection box, place the Mobile Panel 277 safely in its wall holder.

4.6 Switching on and testing the HMI device

Procedure

Proceed as follows:

1. Switch on the power supply.

The display lights up after power is switched on. A progress bar is displayed during startup.

If the HMI device does not start, it is possible the wires on the terminal block have been crossed. Check the connected wires and change the connections if necessary. The loader is displayed once the operating system has started.

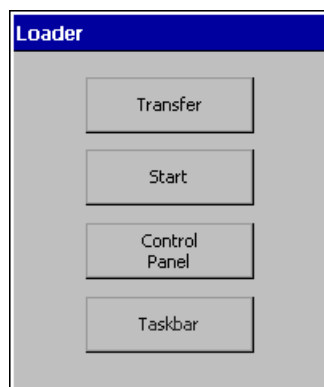

The HMI device automatically switches to "Transfer" mode during initial startup under the following conditions:

- No project is loaded on the device.
- At least one data channel has been configured.

During this process the following dialog appears:

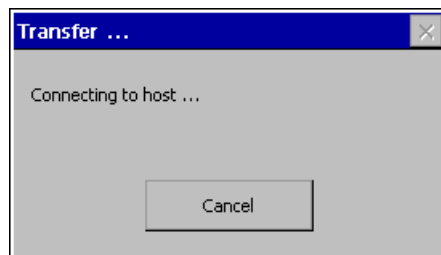

2. Press "Cancel" to stop the transfer.

Result

The loader appears again.

Note

When restarting the system, a project may already be loaded on the HMI device. The system then skips "Transfer" mode and starts the project.

Use the relevant operator control to close the project.

Further information on this may be available in your plant documentation.

Function test

Perform a function test following commissioning. The HMI device is fully functional when one of the following states is indicated:

- The "Transfer" dialog is displayed.
- The loader appears.
- A project is started.

Switching off the HMI device

The following procedure applies if a rechargeable battery is not installed.

Terminate the project at the HMI device before switching it off.

You have the following options for switching off the HMI device:

- Switch off the power supply.
- Pull out the connecting cable from the connection box.

Note

Recovery time

Wait for approximately one second after you have removed the connecting cable from the connection box before you plug the connecting cable back into the connection box.

Wait approximately one second after switching off the power supply before you switch it back on again.

After power failures lasting less than one second the connecting cable has to be disconnected.

Operator controls and displays

5.1 Overview

5.1.1 Mobile Panel 277 8"

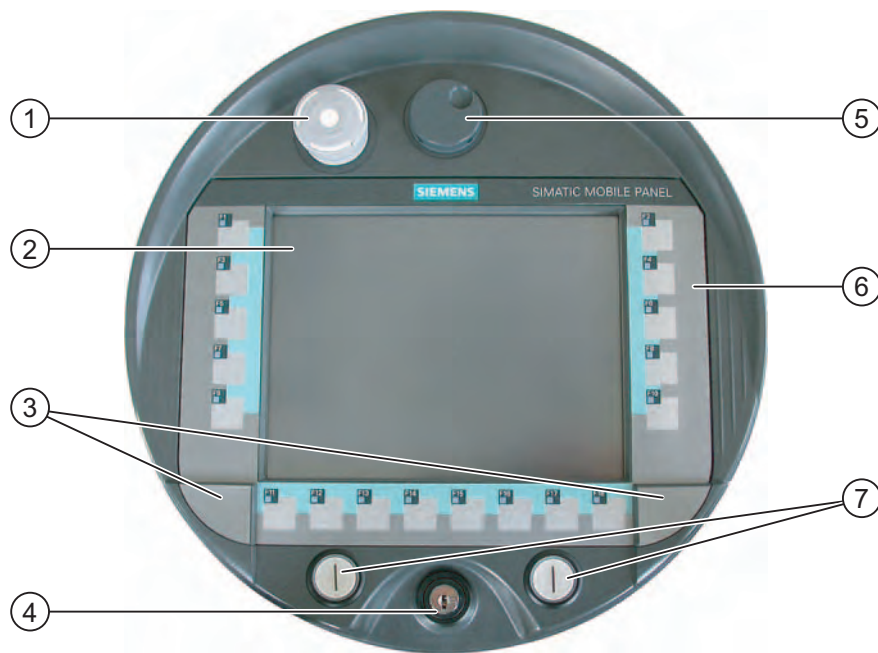

- ① STOP button
- ② Display with touch screen
- ③ Covers for the labeling strip guides
- ④ Key-operated switch
- ⑤ Handwheel
- ⑥ Membrane keyboard
- ⑦ Illuminated pushbutton

Operator control functions

The functions assigned to the function keys, the handwheel, the key-operated switch and the illuminated pushbuttons are determined during configuration. The above-mentioned operator controls do not function outside of a project.

Evaluation and selection of the operator controls

The following information can be transferred between the HMI device and the PLC:

- Direction pulses of the handwheel
- Status of the function keys
- Status of the key-operated switch
- State of the illuminated pushbuttons
- State of the LEDs of the function keys and illuminated pushbuttons

There are two ways of transferring information:

- Direct keys
- System functions of WinCC flexible

Standard input unit

The standard input unit on the HMI device is the touch screen. All operator control objects required for touch operation are displayed on the touch screen once the HMI device has started.

NOTICE
Damage to the touch screen Never touch the touch screen with pointed or sharp objects. Avoid applying excessive pressure to the touch screen with hard objects. Both these will substantially reduce the useful life of the touch screen and even lead to total failure. Do not use anything else but your fingers to operate the touch screen of the HMI device.
Damage to the keyboard Pressing the keys with a hard object considerably reduces the useful life of the key mechanism. Always use your fingers to operate the keys of your HMI device.

5.1.2 Mobile Panel 277 10"



- ① STOP button
- ② Display with touch screen

Standard input unit

The standard input unit on the HMI device is the touch screen. All operator control objects required for touch operation are displayed on the touch screen once the HMI device has started.

NOTICE

Damage to the touch screen

Never touch the touch screen with pointed or sharp objects. Avoid applying excessive pressure to the touch screen with hard objects. Both these will substantially reduce the useful life of the touch screen and even lead to total failure.

You should not use anything but your fingers to operate the touch screen of the HMI device.

A touch pen is more suitable for high-resolution images. Touch pens are available as accessories; see Touch pens (Page 26).

5.2 Operator controls of Mobile Panel 277 8"

5.2.1 STOP button

5.2.1.1 Overview

Introduction

The STOP button is an optional operator control for Mobile Panel 277 8". The STOP button is designed with two circuits and allows a safety-related stop of the system being monitored.

The STOP button meets safety category 3 in accordance with EN 954-1 when used in combination with an external monitoring device. Please refer to the safety information and general instructions chapters for further safety instructions.

When you unplug the Mobile Panel 277 from the connection box, the Stop circuit is either opened or automatically bridged. This is dependent on the type of connection box used.

Possible application areas for the STOP button:

- The STOP button can be used to initiate a process-cycle-specific rapid stop of a monitored system (plant, machine or machine zone). The Stop operation can occur with or without a power shutdown.

Advantages:

- Limits the range of effectiveness
- Fast restart
- No loss of machine coordinates and, thus, no recalibration upon restart
- Preservation of tool and workpiece
- Triggering of the Emergency Stop function of a monitored system by means of looping in the Emergency Stop circuit.

Advantage:

Simple integration in an existing Emergency Stop circuit when the system to be monitored has no option for a fast process stop.

The following figure shows the position of the STOP button, taking the example of Mobile Panel 277 8".

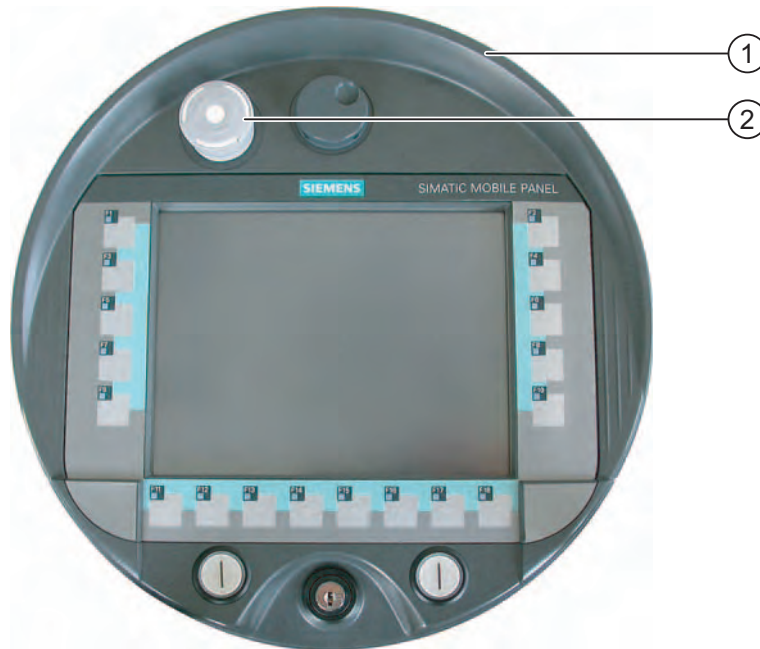

- ① Fall protection
- ② STOP button

Due to its position, the STOP button is equally accessible to both left-handed and right-handed individuals.

Due to its profiled design, the STOP button is easily accessible. Mobile Panel 277 8" is equipped with a collar-type edge to provide fall protection. This feature protects the STOP button without preventing its triggering in case a user unintentionally drops the HMI device.

Operation

The STOP button is operated by pressing the button. Once the stop operation has been initiated, the STOP button remains engaged in the stop position.

Note

The STOP button engages when activated.

Releasing the STOP button

WARNING

If you have activated the STOP button and thereby brought the monitored system to a standstill, the STOP button may only be released under the following conditions:

- The reasons for the stop have been eliminated.
- A safe restart is possible.

In order to release the STOP button, turn it in a clockwise direction. The STOP button then returns on its own to the starting position.

5.2.1.2 Safety Functions of the STOP Button

The STOP button on the Mobile Panel 277 brings about a safety-related Stop of the system being monitored in accordance with EN 60204-1:1997, Section 9.2.5.3. You have the option of implementing a Category 0, 1, or 2 Stop function in accordance with EN 60204-1: 1997, Section 9.2.2. The stop function category must be selected on the basis of a risk assessment.

The Mobile Panel 277's Stop function can, therefore, be used as a reliable machine stop as well as for looping in the Emergency Stop circuit of the system to be monitored.

The signals of the STOP button are wired differently in the two versions of the connection box. In the connection box Plus, the signals control the Stop or Emergency Stop circuit of the system being monitored. If the Mobile Panel 277 is not connected, the Stop or Emergency Stop circuit is closed. In the connection box Basic, on the other hand, the signals of the Stop or Emergency Stop circuit are fed via the STOP button. If the Mobile Panel 277 is not connected, the Stop or Emergency Stop circuit of the system being monitored is open.

The term "Stop loop through" has the following meaning:

The Stop or Emergency Stop circuit of the system or machine is looped through the connection box Plus and is not interrupted. This is independent of whether the Mobile Panel 277 is connected to the connection box or not (and STOP button not activated).

This functionality is only available in the connection box Plus.

 WARNING
Mobile Panel 277 with STOP button If the Mobile Panel 277 is equipped with a STOP button and is not connected to the connection box, a Stop cannot be initiated using the Mobile Panel 277. The STOP button of the Mobile Panel 277 is then ineffective! Install stationary Emergency Stop buttons that are available at all times on the system being monitored. Category 0 or 1 Stop If a Category 0 or 1 Stop circuit is implemented, the stop function must be in effect regardless of the operating mode. A Category 0 Stop must have precedence. Releasing the STOP button must not initiate any dangerous state (see also EN 60204-1:1997, chapter 9.2.5.3). The stop function is not to be used as a replacement for safety equipment.

NOTICE
Several connection boxes Install only one type of connection box (i.e. connection box Plus or connection box Basic) for monitoring your system. STOP button can be activated if the panel is dropped The standstill of the monitored system can be activated under the following conditions: The Mobile Panel 277 is connected to the connection box and the STOP button is activated due to the Mobile Panel 277 falling down or being dropped.

5.2.2 Handwheel

Introduction

The handwheel is an optional operator control for Mobile Panel 277 8". The handwheel can be turned without a stop and does not have a zero position.



- ① Handwheel with recess

Operation

To facilitate operation, the handwheel has a small recess.

See also

Mobile Panel 277 8" (Page 79)

5.2.3 Illuminated Pushbutton

Introduction

The illuminated pushbuttons are optional operator controls for Mobile Panel 277 8" and can be used for high-speed digital input.



① Illuminated pushbutton

Function principle

The illuminated pushbuttons are momentary action switches without latching mechanism.

See also

Mobile Panel 277 8" (Page 79)

5.2.4 Key-operated Switch

Introduction

The key-operated switch is an optional operator control for Mobile Panel 277 8" and is used to lock functions which can be triggered by means of the HMI device.



① Key-operated switch

Operation

The key-operated switch has three positions: I-0-II.

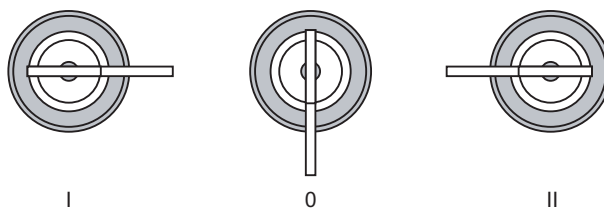

Key-operated switch settings

The key can be removed in the switch setting 0.

Remove the key after use. This avoids possible damage to the key if the HMI device falls down.

Note

The key to the key-operated switch is supplied together with the HMI device. The key does not have an HMI-specific coding, i.e. you can use it for any Mobile Panel 277 8".

See also

Mobile Panel 277 8" (Page 79)

5.2.5 Enabling Switch

Introduction

The enabling equipment consists of two enabling buttons which are installed on the left and right side of the Mobile Panel 277. The switch setting of the two enabling buttons is determined by electrical momentary contact switches. The associated evaluation logic is dual-channel. This means one channel processes the enabling button information digitally and the second channel in analog fashion.

This helps with signal security (diversity).

NOTICE
AND linking is not permitted
Both channels can run staggered signals.
This is why both channels should not be linked using the Boolean operator "AND" but only with an "OR".

The figure below shows the enabling button.



Operation

You only have to activate one enabling button. It is not possible for the PLC to evaluate whether Mobile Panel 277 is operated with one hand or with both.

Note

The enabling buttons and the membrane keyboard can be operated simultaneously, because there is no electrical connection between the two.

The enabling buttons meet the requirements of Safety Category 3 to EN 954-1 when used in combination with an external monitoring device.

Circuit diagram

The figure below shows the operating positions and interconnections of the enabling button.

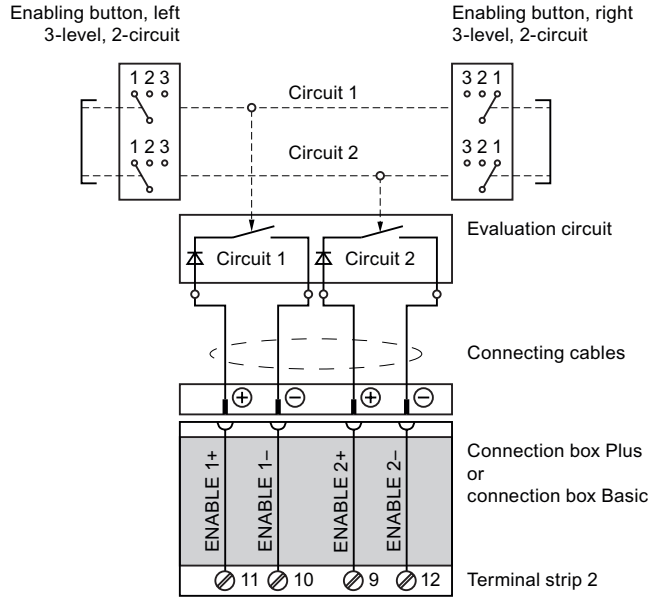

Switch settings

The primary function of the evaluating logic is to detect the three switch settings:

Switch setting	Function	Enabling button	Switch state
1	Neutral position	Not activated	OFF (open)
2	Enable	Activated	ON (closed)
3	Panic	Pressed	OFF (open)



The following figure shows the switching sequence for normal activation.

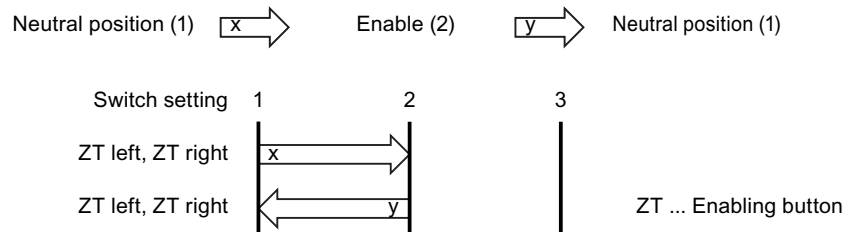

The following figure shows the switching sequence for panic activation.

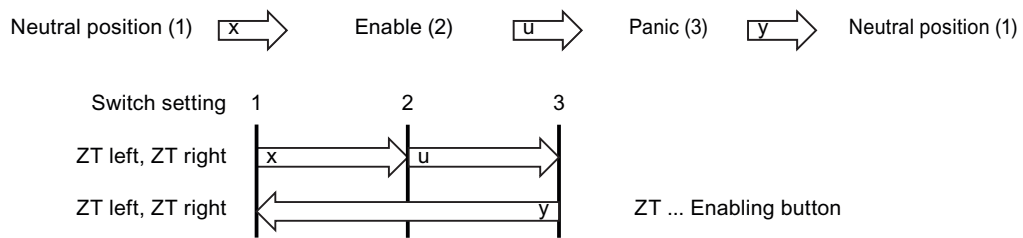

If the operator has pressed the enabling button through to the "Panic" setting, the "Enable" setting will be skipped when the switch is released.

The signals of the enabling button are fed to the connection box via the connecting cable. For special manual operating modes, these signals must be interconnected via two channels from the connection box to the safety circuits for power shutdown.

Note

Releasing the enabling button or pressing it through to the Panic setting does not require acknowledgment of the safety shutdown.

5.2.6 Display the charge status of the bridging battery

Introduction

If the connection cable of the HMI device is disconnected from the connection box, the LEDs F2, F4, F6, F8 and F10 indicate the charge status of the bridging battery. The LED for function key F1 also lights up for max. 9.5 minutes. This duration applies to a 100% charge status. The duration reduces as the charge reduces. The LED F1 flashes for 30 seconds. The HMI device then switches off. Runtime is terminated.

Meaning of LEDs

The number of illuminated LEDs indicates the charge status as follows:

LED of the function keys lights up	Charging status
F2, F4, F6, F8, F10	100 %
F4, F6, F8, F10	≤ 80 %
F6, F8, F10	≤ 60 %
F8, F10	≤ 40 %
F10	≤ 20 %

Note

This applies to the storage of rechargeable batteries:

You can achieve the optimal service life for rechargeable batteries by storing them with 40 to 60% of their charge capacity. Manufacturers recommend storage at 15° C – a compromise between accelerated aging and self-discharge.

A rechargeable battery should be charged every six months with 40 to 60% of its charge capacity. The general rule is that a Lithium-Ion rechargeable battery has lost more than 50% of its charge capacity after approx. three years.

Connecting the connection cable

If the HMI device is still in Transfer mode and the connection cable is connected to the connection box, the function of the "Display charge status" LEDs is disabled. Runtime is called. See chapter Connecting the Connecting Cable (Page 75).

5.2.7 Configuring the evaluation of operator controls

5.2.7.1 Overview

Operator controls

The following information can be transferred between the HMI device and the PLC:

- Direction pulses of the handwheel
- Status of the function keys
- Status of the key-operated switch
- State of the illuminated pushbuttons
- State of the function keys and illuminated pushbutton LEDs

There are two ways of transmitting information:

- Direct keys
- System functions of WinCC flexible

Note

The following sections are intended for the configuration engineer of the HMI device.

5.2.7.2 Evaluating operator controls as direct keys

Introduction

You can configure the operator controls of the HMI device as direct keys.

The states of the following operator controls are available directly in the I/O area of the PLC:

- Direction pulses of the handwheel
- The switching state of the function keys
- The switching state of the key-operated switch
- The switching state of the illuminated pushbuttons

Byte assignment

The following figure shows the assignment of the keys (inputs) and LEDs (outputs) to the bytes in the PLC process image.

Check for additional information in your plant documentation, if necessary.

Button bits								Byte	LED bits							
7	6	5	4	3	2	1	0		7	6	5	4	3	2	1	0
F8	F7	F6	F5	F4	F3	F2	F1	n	F8	F7	F6	F5	F4	F3	F2	F1
F16	F15	F14	F13	F12	F11	F10	F9	n + 1	F16	F15	F14	F13	F12	F11	F10	F9
						F18	F17	n + 2							F18	F17
			T2		T1	S1	S0	n + 3						T2	T1	
I7	I6	I5	I4	I3	I2	I1	I0	n + 4								
D7	D6	D5	D4	D3	D2	D1	D0	n + 5								
7	6	5	4	3	2	1	0	n + 6								
15	14	13	12	11	10	9	8	n + 7								
23	22	21	20	19	18	17	16	n + 8								
31	30	29	28	27	26	25	24	n + 9								

- F Bit for function key
- S Bit for key-operated switch
- T1 Bit for left illuminated pushbutton
- T2 Bit for right illuminated pushbutton
- I Bit for handwheel pulses, forwards
- D Bit for handwheel pulses, backwards

The bytes "n+6" to "n+9" contain the direct key bits for the touch buttons.

Bit coding

The following tables show the bit coding for function keys, key-operated switch, illuminated pushbutton and handwheel:

- Bit coding of function keys

State	F1 to F18
Not pressed	0
Pressed	1

- Bit coding of function key LEDs

State	F1 to F18
LED not illuminated	0
LED is illuminated	1

- Bit coding of key-operated switch

State	S1	S0	Key position
Position 0	0	0	In middle position
Position I	0	1	Turned in clockwise direction up to stop
Position II	1	0	Turned counter-clockwise up to stop

- Bit coding of illuminated pushbuttons

State	T1	T2
Not pressed	0	0
Pressed	1	1

- Bit coding of illuminated pushbutton LEDs

LED status	T1	T2
Off	0	0
On permanently	1	1

- Bit coding of handwheel

- A setpoint is not specified for the handwheel.
- After start-up of the HMI device, the bytes "n+4" to "n+5" are set to zero.

Rotation of the handwheel produces positive or negative pulses depending on the rotation direction. The number of positive pulses are stored in bits I0 to I7. The number of negative pulses are stored in bits D0 to D7. The values are entered in binary format, where bit 0 is the lowest and bit 7 is the highest valued bit.

A complete handwheel revolution yields 50 pulses.

- Every pulse of the handwheel is added to byte "n+4" or "n+5" depending on the direction of rotation. There are no negative values. When the possible value range is exceeded, there is an overflow:

If a value of 255 is increased by one pulse, a value of 0 results.

Example of bit coding for handwheel

The following table includes an example for rotation direction determination. The pulses are stored in bytes "n+4" and "n+5" and are measured during the points in time t₁ to t₄.

The numbers in the following table represent a byte in the PLC.

Evaluation time	Handwheel		Evaluation
	Pulses, forwards	Pulses, backwards	
t ₁	255 (≙ -1)	245 (≙ -11)	--
t ₂	10	245 (≙ -11)	Pulses, forwards: 11 Pulses, backwards: 0 Resulting value: +11
t ₃	10	4	Pulses, forwards: 0 Pulses, backwards: 15 Resulting value: -15
t ₄	15	5	Pulses, forwards: 5 Pulses, backwards: 1 Resulting value: +4

The difference in pulses at times t_n and t_{n+1} allows you to determine the resulting value and thus the direction of rotation.

Establish the following values:

- Number of pulses, forwards
 - At time t_n
 - At time t_{n+1}
- Number of pulses, backwards
 - At time t_n
 - At time t_{n+1}

From this, you determine the resulting value. This is calculated as:

$$\begin{aligned}
 & \text{Pulses, forwards, } t_{n+1} \\
 - & \text{Pulses, forwards, } t_n \\
 - & \text{Pulses, backwards, } t_{n+1} \\
 + & \text{Pulses, backwards, } t_n \\
 = & \text{Resulting value}
 \end{aligned}$$

Reaction time

The bytes "n+4" and "n+5" must be retrieved on the PLC side within a second and cyclically. This ensures that no more than 256 pulses can be added between two scans of the handwheel. For 256 pulses, approximately 4.5 revolutions of the handwheel are required.

The rotary pulse encoder supplies a maximum of 200 pulses per second.

NOTICE
Sample cycle time The input pulses should take effect immediately on the PLC and cause a response in the system. Set a scan cycle ≤ 100 ms in the PLC to achieve this.

5.2.7.3 Controlling the LEDs of the function keys by means of system functions

Application

LEDs are integrated in the HMI device's function keys F1 to F18. The integrated LEDs can be controlled from the PLC.

The LEDs can assume the following states:

- Off
- Flashing slowly
- Flashing quickly
- On

You can use the LED to signal to the user that a function key should be pressed, in a running project.

Bit assignment

The following table shows the possible states of the LEDs and the corresponding entries in bit n+1 and bit n of the LED tags.

Bit n+1	Bit n	LED status
0	0	Off
0	1	Flashing quickly
1	0	Flashing slowly
1	1	ON (continuous)

5.2.7.4 Evaluating the handwheel by means of system functions

Application

The handwheel is an optional operator control for the Mobile Panel. You can enter incremental values using the handwheel in the runtime project.

Note

Do not configure limit values in WinCC flexible for tags assigned to the handwheel.

Evaluation of the incremental values

If the signals of the handwheel are assigned to a WinCC flexible tag, then the forward and backward increments will be set off against each other. This defines the absolute value of increments. The maximum or minimum value of increments entered until the overflow is reached depends on the type of tag assigned.

A complete handwheel revolution yields 50 pulses. The rotary pulse encoder supplies a maximum of 200 pulses per second.

Example

- The handwheel has a starting value of 120 increments.
- You rotate the wheel 10 increments forwards and 3 increments backwards.
This results in a new value of 127 increments.

5.2.7.5 Evaluating the key-operated switch by means of system functions

Application

The key-operated switch is an optional operator control of the HMI device. The key-operated switch serves to lock functions in a running project which can be triggered by means of the HMI device.

Bit assignment

The following table shows the bit assignment for the tag of the key-operated switch:

Bit 1	Bit 0	Key position
0	0	Central position
0	1	Turned in clockwise direction up to stop
1	0	Turned counter-clockwise up to stop

Note

If you use a tag of the "Boolean" type for the key-operated switch, the following assignment applies:

- Status "0": Central position of the key-operated switch
 - Status "1": Key-operated switch turned clockwise or counter-clockwise to the stop
-

5.2.7.6 Controlling and evaluating the illuminated pushbutton by means of system functions

Application

The illuminated pushbuttons are optional operator controls of the HMI device. The integrated LEDs can be controlled from the PLC.

The LEDs can assume the following states:

- Off
- Flashing slowly
- Flashing quickly
- On

You can use the LEDs to signal to the user that a function key should be pressed in a running project.

Bit assignment

The following table shows the bit assignment for the status tags of the illuminated pushbuttons:

Bit 0	Status of the illuminated pushbutton
0	Not pressed
1	Pressed

The following table shows the bit assignment for the LED tags of the illuminated pushbuttons:

Bit n+1	Bit n	LED status
0	0	Off
0	1	Flashing quickly
1	0	Flashing slowly
1	1	ON (continuous)

5.3 Operator controls of Mobile Panel 277 10"

5.3.1 STOP button

5.3.1.1 Overview

Overview

The STOP button is designed with two circuits and allows a safety-related stop of the system being monitored.

The STOP button meets safety category 3 in accordance with EN 954-1 when used in combination with an external monitoring device. Please refer to the "Safety instructions and general notes" chapter for further safety instructions.

The stop circuit of the system to be monitored retains the closed state when you disconnect Mobile Panel 277 10" from the connection box.

Possible application areas for the STOP button:

- The STOP button can be used to initiate a process-cycle-specific rapid stop of a monitored system (plant, machine or machine zone). The Stop operation can occur with or without a power shutdown.

Advantages:

- Limitation of effective range
- Fast restart
- No loss of machine coordinates and thus no recalibration upon restart
- Preservation of tool and workpiece

- Triggering of the Emergency Stop function of a monitored system by means of looping in the Emergency Stop circuit.

Advantage:

Simple integration in an existing Emergency Stop circuit when the system to be monitored has no option for a fast process stop.



① STOP button

Due to its position, the STOP button is equally accessible to both left-handed and right-handed individuals.

Due to its profiled design, the STOP button is easily accessible. The STOP button can be activated if the panel is dropped.

Operation

The STOP button is operated by pressing the button. Once the stop operation has been initiated, the STOP button remains engaged in the stop position.

Note

The STOP button engages when activated.

Releasing the STOP button

 WARNING
If you have activated the STOP button and thereby brought the monitored system to a standstill, the STOP button may only be released under the following conditions: The reasons for the stop have been eliminated. A safe restart is possible.

In order to release the STOP button, turn it in a clockwise direction. The STOP button then returns on its own to the starting position.

5.3.1.2 Safety Functions of the STOP Button

The STOP button on the Mobile Panel 277 brings about a safety-related Stop of the system being monitored in accordance with EN 60204-1:1997, Section 9.2.5.3. You have the option of implementing a Category 0, 1, or 2 Stop function in accordance with EN 60204-1: 1997, Section 9.2.2. The stop function category must be selected on the basis of a risk assessment.

The Mobile Panel 277's Stop function can, therefore, be used as a reliable machine stop as well as for looping in the Emergency Stop circuit of the system to be monitored.

The signals of the STOP button are wired differently in the two versions of the connection box. In the connection box Plus, the signals control the Stop or Emergency Stop circuit of the system being monitored. If the Mobile Panel 277 is not connected, the Stop or Emergency Stop circuit is closed. In the connection box Basic, on the other hand, the signals of the Stop or Emergency Stop circuit are fed via the STOP button. If the Mobile Panel 277 is not connected, the Stop or Emergency Stop circuit of the system being monitored is open.

The term "Stop loop through" has the following meaning:

The Stop or Emergency Stop circuit of the system or machine is looped through the connection box Plus and is not interrupted. This is independent of whether the Mobile Panel 277 is connected to the connection box or not (and STOP button not activated).

This functionality is only available in the connection box Plus.

 WARNING
Mobile Panel 277 with STOP button If the Mobile Panel 277 is equipped with a STOP button and is not connected to the connection box, a Stop cannot be initiated using the Mobile Panel 277. The STOP button of the Mobile Panel 277 is then ineffective! Install stationary Emergency Stop buttons that are available at all times on the system being monitored. Category 0 or 1 Stop If a Category 0 or 1 Stop circuit is implemented, the stop function must be in effect regardless of the operating mode. A Category 0 Stop must have precedence. Releasing the STOP button must not initiate any dangerous state (see also EN 60204-1:1997, chapter 9.2.5.3). The stop function is not to be used as a replacement for safety equipment.

NOTICE**Several connection boxes**

Install only one type of connection box (i.e. connection box Plus or connection box Basic) for monitoring your system.

STOP button can be activated if the panel is dropped

The standstill of the monitored system can be activated under the following conditions:

The Mobile Panel 277 is connected to the connection box and the STOP button is activated due to the Mobile Panel 277 falling down or being dropped.

5.3.2 Enabling Switch

Introduction

The enabling device consists of two enabling buttons which are installed on the left and right side of the Mobile Panel 277. The switch setting of the two enabling buttons is determined by electrical switches. The associated evaluation logic is dual-channel. This means one channel processes the enabling button information digitally and the second channel in analog fashion.

This helps with signal security (diversity).

NOTICE**AND linking is not permitted**

Both channels can run staggered signals.

This is why both channels should not be linked using the Boolean operator "AND" but only with an "OR".

The figure below shows the enabling button.



Operation

You only have to activate one enabling button. It is not possible for the open-loop control to evaluate whether Mobile Panel 277 is operated with one hand or with both.

Note

The enabling buttons and the membrane keyboard can be operated simultaneously, because there is no electrical connection between the two.

The enabling buttons meet the requirements of Safety Category 3 to EN 954-1 when used in combination with an external monitoring device.

Circuit diagram

The figure below shows the switch settings and interconnections of the enabling button.

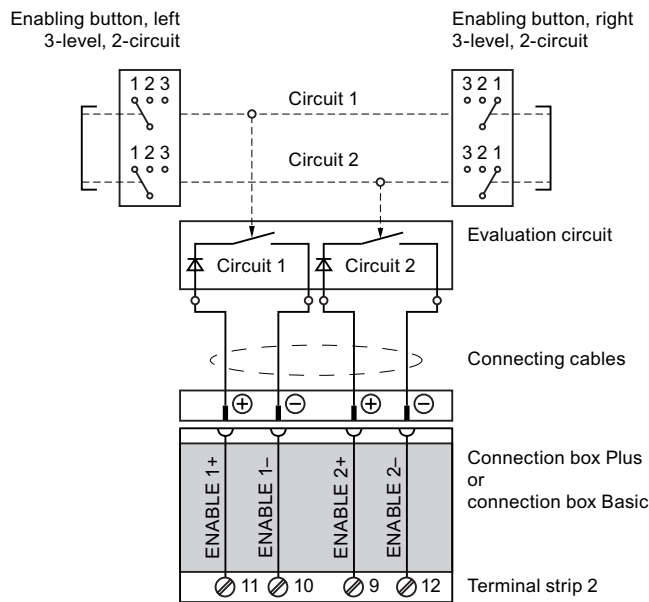

Switch settings

The primary function of the evaluation logic is to detect the three switch settings:

Switch setting	Function	Enabling button	Switch state
1	Neutral position	not activated	OFF (open)
2	Enable	activated	ON (closed)
3	Panic	pressed	OFF (open)



The following figure shows the switching sequence for normal activation.

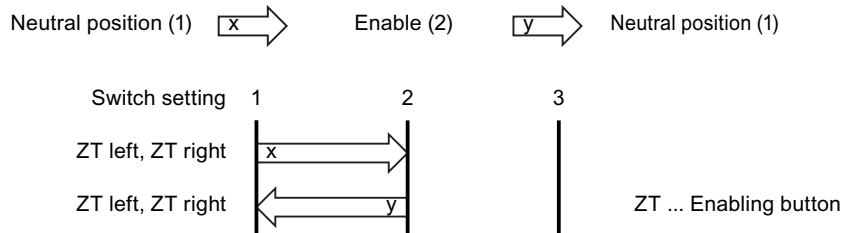

The following figure shows the switching sequence for panic activation.

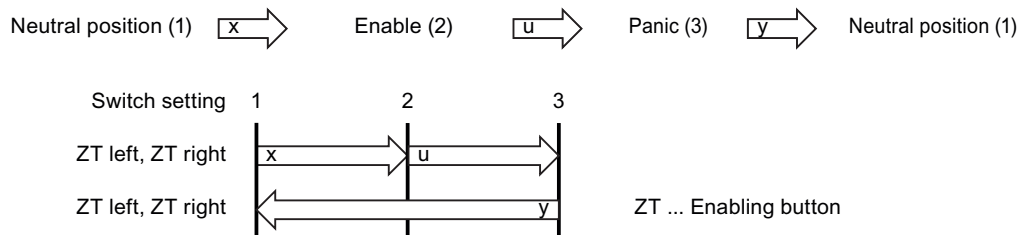

If the operator has pressed the enabling button through to the "Panic" setting, the "Enable" setting will be skipped when the switch is released.

The signals of the enabling button are fed to the connection box via the connection cable. For special manual operating modes, these signals must be interconnected via two channels from the connection box to the safety circuits for power shutdown.

Note

Releasing the enabling button or pressing it through to the Panic setting does not require acknowledgment of the safety shutdown.

5.3.3 Configuring the evaluation of operator controls

5.3.3.1 Overview

Operator controls

There are two ways of transferring data between the HMI device and the PLC:

- Direct keys within the project
- System functions of WinCC flexible

Note

The following sections are intended for the configuration engineer of the HMI device.

5.3.3.2 Evaluating operator controls as direct keys

Introduction

The touch buttons of a project can be assigned direct key functions.

Byte assignment

The following figure shows the byte assignment of the direct key bits for touch buttons in the process image of the PLC.

Check for additional information in your plant documentation, if necessary.

Button bits								Byte
7	6	5	4	3	2	1	0	
7	6	5	4	3	2	1	0	n
15	14	13	12	11	10	9	8	n + 1
23	22	21	20	19	18	17	16	n + 2
31	30	29	28	27	26	25	24	n + 3
39	38	37	36	35	34	33	32	n + 4

Bytes "n" to "n+4" contain the direct key bits for the touch buttons.

5.4 Using memory cards

Requirements

The terminal compartment of the Mobile Panel 277 is open.

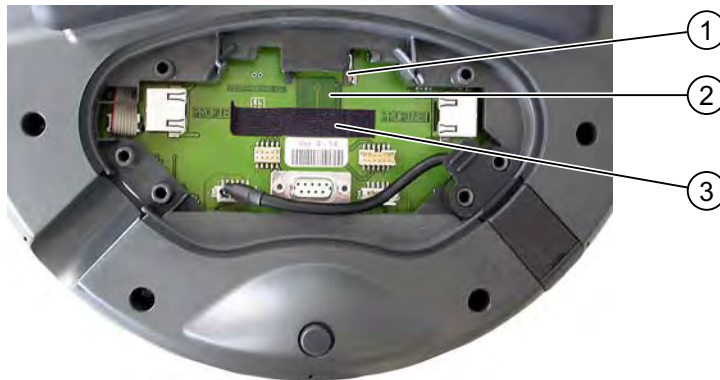

- ① Slot
- ② Memory card symbol
- ③ Velcro strip for fastening the memory card

Procedure for inserting a memory card

Proceed as follows:

1. Remove the Velcro strip.
2. Insert the memory card into the slot.

Pay attention to the memory card symbol when inserting the memory card. An arrow on the memory card indicates the front side and the direction of insertion. When the memory card is correctly inserted into the slot, it stands approx. 3mm proud of the slot.

3. Close the Velcro strip.

Procedure for unplugging a memory card

Proceed as follows:

1. Remove the Velcro strip.
2. Pull the memory card out of the slot.
3. Deposit the memory card in a safe place.

See also

Opening and Closing the Terminal Compartment (Page 69)

5.5 Labeling the function keys on Mobile Panel 277 8"

Introduction

You can label the function keys on Mobile Panel 277 8" for project-specific applications. Use labeling strips to do so.

NOTICE

Do not write on the keyboard to label the function keys.
--

Printing labeling strips

WinCC flexible comes with a range of labeling strip templates. You will find further information regarding the location of the templates in the WinCC Online Help.

Any printable and writable foil can be used as labeling strips. Use transparent foil so that the LEDs of the function keys can be seen. Permitted thickness of the labeling strip: 0.13 mm. Paper should not be used as labeling strips.

Labeling strip dimensions

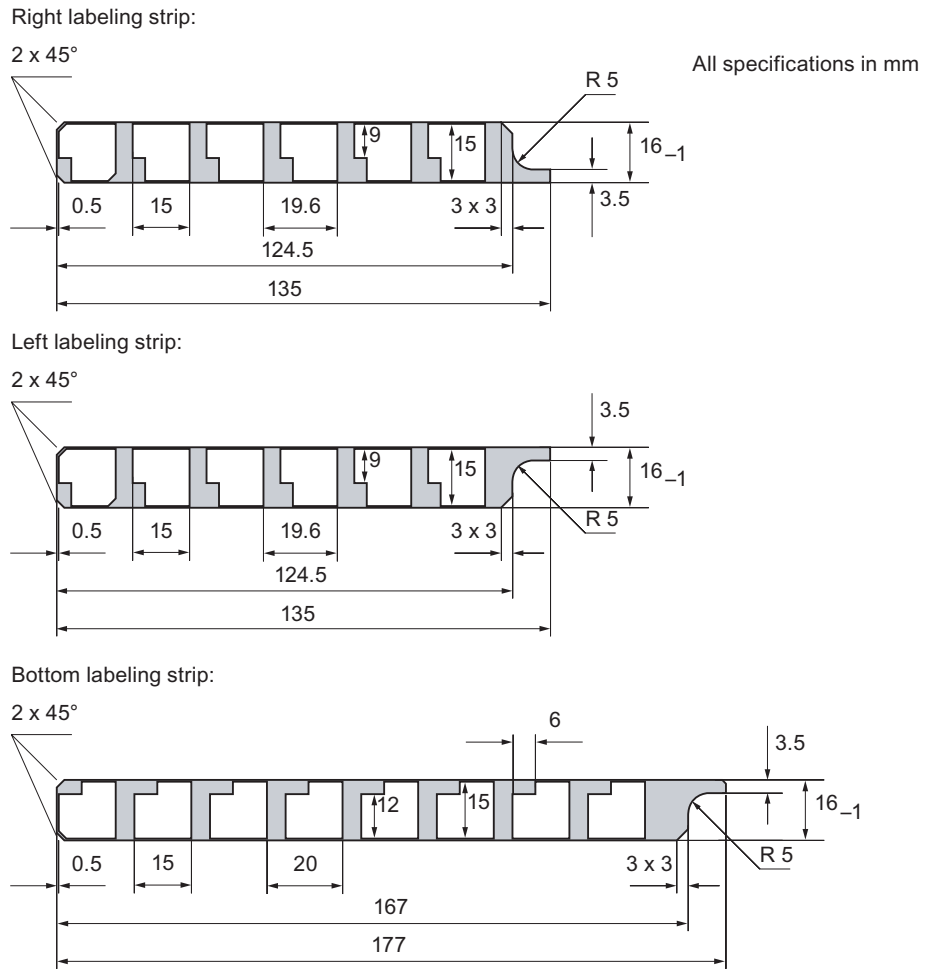

Procedure for attaching labeling strips

The following steps apply for the initial attaching of labeling strips.

Proceed as follows:

1. Lay the Mobile Panel 277 on its back.
2. Remove the sticker from the cover cap.



3. Unscrew both cover caps.
4. Pull the labeling strips out of the guides.
5. Inscribe the labeling strips in accordance with the plant.
Wait for the printed labeling strips to dry before you insert them.
6. Push the labeling strips into the guides.
7. Screw both cover caps back on.
Screwed on cover caps with inserted rubber seals satisfy protection class IP65.
8. Place the sticker on to the cover caps.

Procedure for exchanging labeling strips

Should the exchange of labeling strips become necessary, these can be reordered.

See also

Accessory kit for Mobile Panel 277 8" (Page 20)

5.6 Holding the Mobile Panel and attaching it to the wall holder

Holding the mobile panel

The following figure shows the forearm position for left and right hand operation, using Mobile Panel 277 10" as an example.



The depicted postures provide sufficient freedom of movement while servicing the monitored system.

The depicted forearm holding method enables both right and left-handed persons to use the HMI device with equal ease. The free hand can be used to operate the control elements on the front side. The hand holding the HMI device can also be used to activate the enabling button. The acknowledgment of the control input is also given if you only press one of the enabling buttons.

The enabling button is required for the confirmation of axis movements. The enabling button is optimally accessible. The enabling button triggers a safety shutdown in the event of a panic reaction to danger (release or cramping).

The STOP button can also be quickly reached with your free hand.

Holding the Mobile Panel for entering data

NOTICE

If you are manually controlling potentially dangerous movements in the special operating modes, you must use the above shown forearm holding method. Use this forearm holding method, for example, to quickly reach the STOP button or press down the enabling button in the event of a dangerous situation.

If only entering data without controlling potentially dangerous movements, you can hold the HMI device with both hands on its left and right side without deploying the forearm method.

Attaching the Mobile Panel 277 to a wall holder

A wall holder is available for securely fixing the HMI device in position. The wall holder can be used to operate your Mobile Panel 277 as a stationary HMI device.

The following figure shows an HMI device attached to the wall holder, using Mobile Panel 277 8" as an example.



NOTICE
Operability If the HMI device is hooked into an unsuitable wall holder, the operability of the emergency STOP button can be impaired.

5.7 Connection box

5.7.1 STOP button on the connection box Plus

Introduction

A connection box Plus differs from a connection box Basic in that it has four relays mounted on the board.

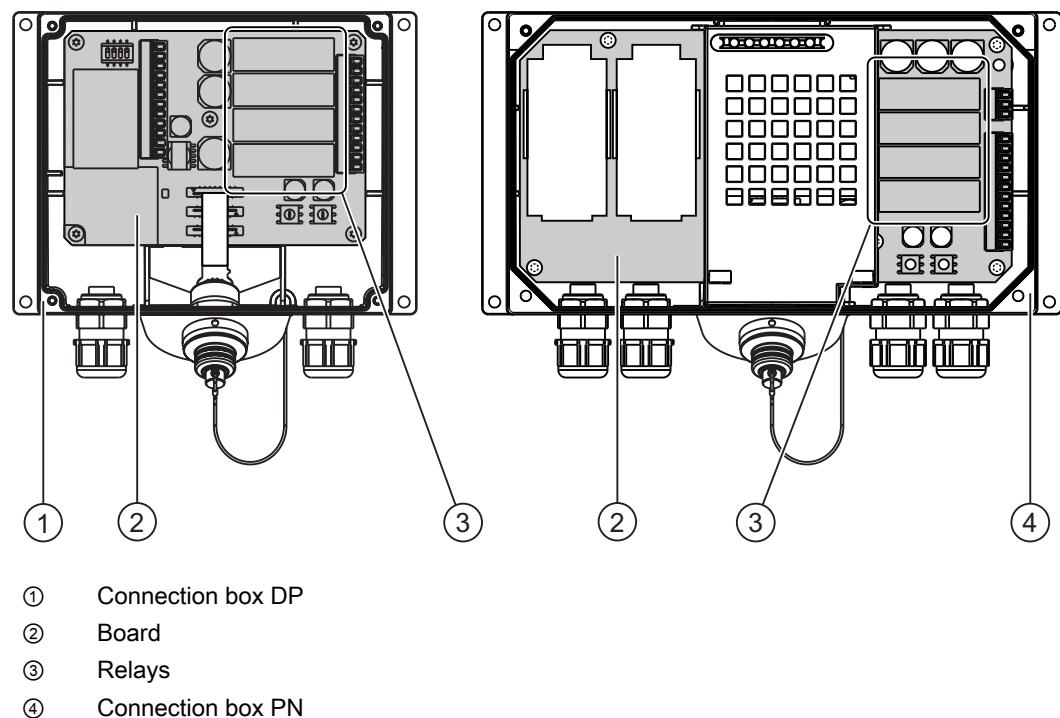

Switching states of the Stop or Emergency Stop circuit with connection box Plus

The Stop or Emergency Stop circuit switching statuses for a connected Mobile Panel 277 with a STOP button and connection box Plus are:

Mobile Panel 277	STOP button	Status of the Stop or Emergency Stop circuit
Is connected	Not pressed	The Stop or Emergency Stop circuit remains closed.
Is connected	Pressed	The Stop or Emergency Stop circuit is open. The system being monitored is shut down.
Is not connected	–	The Stop or Emergency Stop circuit remains closed.

The Stop or Emergency Stop circuit switching statuses for a connected Mobile Panel 277 without a STOP button and connection box Plus are:

Mobile Panel 277	STOP button	Status of the Stop or Emergency Stop circuit
Is connected	Not available	The Stop or Emergency Stop circuit remains closed.
Is not connected	Not available	The Stop or Emergency Stop circuit remains closed.

⚠ WARNING

Disconnecting the Mobile Panel 277

If you disconnect the Mobile Panel 277 from the connection box Plus, the Stop or Emergency Stop circuit is closed and the Stop status of the system being monitored will be nullified. This is independent of whether the STOP button was pressed on the Mobile Panel 277 or not!

NOTICE

Approximately 100 ms elapse between the time the STOP button is pressed and response of the Stop contacts at the connection box Plus.

5.7.2 STOP button on the connection box Basic

Introduction

The "Stop loop through" function is not implemented on the connection box Basic. Relays, such as on the connection box Plus, are therefore not required.

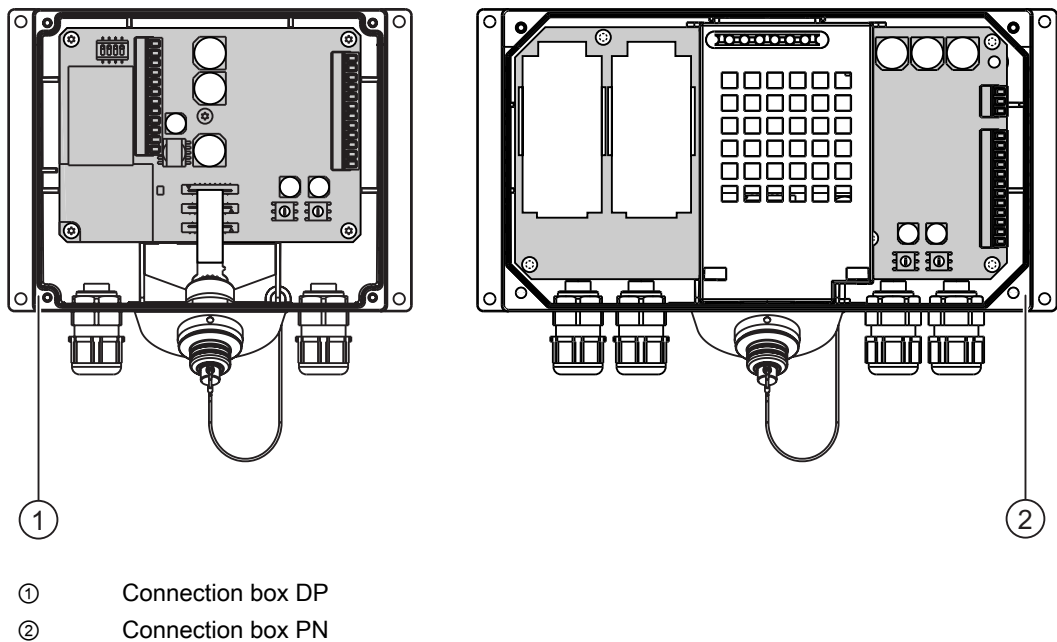

⚠ CAUTION

If the Mobile Panel 277 is connected, the Stop or Emergency Stop circuit is controlled via the STOP button. If you unplug the Mobile Panel 277's connecting cable from the connection box Basic, the following occurs:

- The Stop or Emergency Stop circuit will be interrupted.
- A safe machine stop or Emergency Stop of the system being monitored will be carried out.

Switching states of the Stop or Emergency Stop circuit with connection box Basic

The Stop or Emergency Stop circuit switching statuses for a connected Mobile Panel 277 with a STOP button and connection box Basic are:

Mobile Panel 277	STOP button	Status of the Stop or Emergency Stop circuit
Is connected	Not pressed	The Stop or Emergency Stop circuit remains closed.
Is connected	Pressed	The Stop or Emergency Stop circuit is open. The system being monitored is shut down.
Is not connected	–	The Stop or Emergency Stop circuit is open. The system being monitored is shut down.

The stop circuit switch states for a connected Mobile Panel 277 without a STOP button and connection box Basic are:

Mobile Panel 277	STOP button	Status of the Stop or Emergency Stop circuit
Is connected	Not available	The Stop or Emergency Stop circuit remains closed.
Is not connected	Not available	The Stop or Emergency Stop circuit is open. The system being monitored is shut down.

⚠ WARNING**Releasing the STOP button**

The following applies if you have shut down the monitored system:

You may only release the STOP button and restart the system being monitored under the following conditions:

- The reasons for the stop have been eliminated.
- A safe restart is possible.

5.7.3 Displays on the connection box PN

Introduction

There are six LEDs on the front side of the connection box PN, which indicate the state of communication.

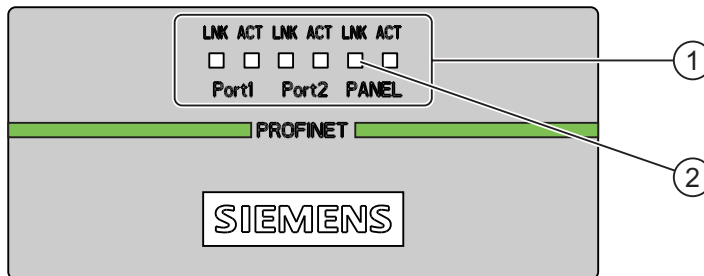

- ① LED display
- ② LED

There is an "LNK" and "ACT" LED available for the following connections:

- PROFINET connection Port1
- PROFINET connection Port2
- Mobile Panel 277

Meaning of the LED displays

- LED "LNK"

The LED is permanently lit if the associated port of the connection box PN is connected to a cable and the connection is faultless.

- LED "ACT"

The LED flashes when data is transferred via the associated port of the connection box PN.

Configuring the operating system

6.1 Loader

Loader

The figure below shows the loader.

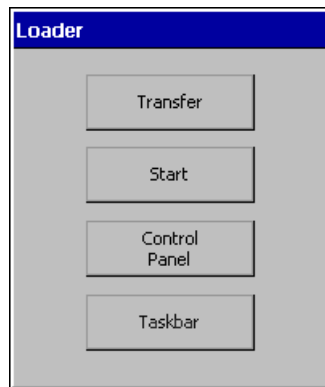

The loader buttons have the following functions:

- The "Transfer" button sets the HMI device to "Transfer" mode.
The transfer mode can only be activated when at least one data channel has been enabled for the transfer.
- Press the "Start" button to start the project that exists on the HMI device.
If you do not perform an operation, the project on the HMI device will automatically start after a delay.
- Press the "Control Panel" button to open the Control Panel of the HMI device.
You can change various settings in the Control Panel, for example the transfer settings.
- Press the "Taskbar" button to activate the taskbar with opened Windows CE Start menu:

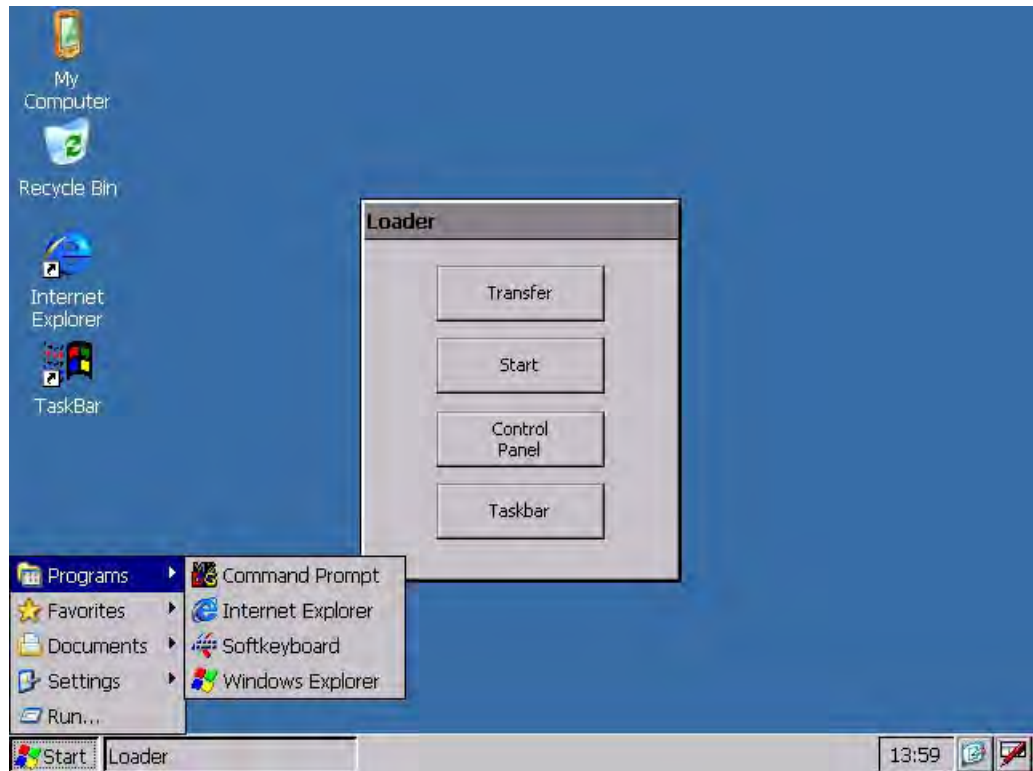

Open loader

The following options are available to open the loader:

- The loader appears briefly after starting the HMI device.
- The loader appears when the project is closed.

If configured, use the relevant operator control to close the project.

Additional information on this topic may be available in your plant documentation.

Password protection

NOTICE
If the password is no longer available, you can only cancel password protection by updating the operating system. All data on the HMI device will be deleted when you update the operating system.

You can protect the Control Panel and taskbar from unauthorized access.

You can only operate the "Transfer" and "Start" buttons if you do not enter a password.

This prevents inadvertent operations and increases security for the plant or machine. You can then no longer change the settings outside the current project.

Pocket Internet Explorer

Pocket Internet Explorer is installed on the HMI device.



Welcome to Microsoft Pocket Internet Explorer



© 2004 Microsoft Corporation. All rights reserved. [Terms of use.](#)

Note

The Pocket Internet Explorer and the PC version of the Internet Explorer differ in terms of functional range.

For further information, please refer to Microsoft's website.

6.2 Control Panel

6.2.1 Overview

Control Panel of the HMI device



The HMI device Control Panel can be used to modify the following HMI device settings:

- Date/time
- Screen saver
- Regional settings
- Transfer settings
- Network settings
- Delay time
- Password

Opening the Control Panel

The Control Panel can be opened as follows:

- In the startup phase
Press "Control Panel" to open the HMI device Control Panel in the loader.
- In a running project
Operate the control object provided for the respective task, if configured.















Alternatively you can open the Control Panel from the Windows CE start menu.





- Open the Windows CE start menu.
 - Alternatively, press the  key twice on the alphanumerical screen keyboard.
The Windows start menu opens.
- Open the Control Panel with "Settings > Control Panel".

6.2.2 Reference

Overview of functions

The following table shows the settings in the Control Panel.

Icon	Function
	Backup and Restore with the Memory Card (Page 160)
	Importing and Deleting Certificates (Page 159)
	Setting the date and time (Page 129)
	Configuring the Screen Keyboard (Page 122)
	Changing General Internet Settings (Page 155)
	Setting the Proxy Server (Page 156)
	Changing Privacy Settings (Page 157)
	Setting the Character Repetition of the Keyboard (Page 123)
	Setting the Double-click (Page 125)
	Changing the Network Configuration (Page 152)
	<ul style="list-style-type: none"> • IP address • Name server
	Changing the Logon Data (Page 153)
	Backing up Registry Information (Page 132)
	Changing Screen Settings (Page 134)
	Displaying Information about the HMI Device (Page 139)
	Restarting the HMI Device (Page 138)
	Calibrating the Touch Screen (Page 126)
	Display rechargeable battery charge level (Page 163)
	Activate Memory Management (Page 164)
	Changing Password Protection (Page 128)
	Changing the Printer Properties (Page 136)
	Enabling PROFINET IO (Page 148)
	Changing Regional Settings (Page 131)
	<ul style="list-style-type: none"> • Number format • Currency • Time format • Date format
	Changing MPI/PROFIBUS DP Settings (Page 143)

Icon	Function
	Setting the screen saver (Page 135)
	Displaying System Properties (Page 140)
	Setting the device name of the HMI device (Page 151)
	Configuring the data channel (Page 145)
	Setting the Delay Time (Page 141)
	Changing E-Mail Settings (Page 154) ¹⁾

1) The "WinCC flexible Internet Settings" tab can contain additional tabs. This depends on the options that have been enabled for network operation in the project.



6.2.3 Operating the Control Panel

Introduction

The Control Panel is operated with the HMI device touch screen.

Procedure



Proceed as follows to change settings in the Control Panel:

1. Close the project.
Use the provided operating element.
The Loader appears.
2. Open the Control Panel by pressing the "Control Panel" button.
3. To open the required dialog, double-click its symbol.
4. Change as required by touching the tab.
5. Now make the necessary changes.
Touch the respective input object to make entries.
 - Use the screen keyboard of the HMI device to enter the new values in the text boxes.
 - Touch a button to operate it.
 - Touch the selection box to open a drop down list box. Touch the required entry from the drop down list box.
 - Touch the check box to activate or deactivate a check box.
 - Touch a radio button to select it.
6. Confirm the selection with the  button or abort the entry with the  button.
The dialog closes.
7. Close the Control Panel with the  button.
8. Start the project by pressing the "Start" button in the Loader.

Input with the screen keyboard

A screen keyboard is available for data input. The screen keyboard is displayed as soon as you touch a text box. You can also call up the screen keyboard directly from the Control Panel.

Display methods for the screen keyboard

You can change the display method for the screen keyboard and the position on the screen can be fixed. Confirm the entry with the  button or abort the entry with the  key. Either action closes the screen keyboard.

- Numerical screen keyboard



- Alphanumerical screen keyboard









The alphanumerical screen keyboard has various levels.

- Normal level
- Shift level

- Reduced screen keyboard



Changing the display of the screen keyboard

Key	Function
	Switching between the numerical and alphanumerical keyboard
	Switching between the normal level and Shift level of the alphanumerical screen keyboard
	Activation and deactivation of the numerical and alphanumerical keys of the alphanumerical screen keyboard
	Switching from full display to reduced display
	Switching from reduced display to full display
	Closing of reduced display of the screen keyboard

Moving the screen keyboard

In order to move the screen keyboard, proceed as follows:

Touch the  symbol.

1. Touch and move the screen keyboard on the touch screen.

Release the  symbol when the required position is reached.

See also

Configuring the Screen Keyboard (Page 122)

6.3 Changing settings for operation

6.3.1 Configuring the Screen Keyboard

Introduction

You can change the layout and the position of the screen keyboard as follows.

Requirements

You have opened the "Siemens HMI InputPanel - Options" dialog by pressing the "InputPanel"  icon.

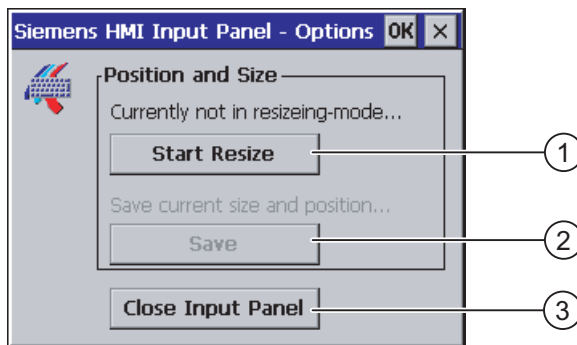

- ① Button for displaying the screen keyboard
- ② Button for saving the screen keyboard settings
- ③ Button for closing the screen keyboard

Procedure

Proceed as follows:

1. Press the "Open Input Panel" button to display the screen keyboard.
2. By pressing the  button, you can switch between the numerical and alphanumerical screen keyboard.
3. Set the position of the screen keyboard by moving the screen keyboard on the screen.
4. Save your settings by pressing the "Save" button.
5. Close the screen keyboard by pressing the "Close Input Panel" button.
6. Close the dialog.

Result

The screen keyboard settings have been modified.

6.3.2 Setting the Character Repetition of the Keyboard

Introduction

You can set the character repeat for the screen keyboard in the Control Panel.

Requirements

You have opened the "Keyboard Properties" dialog box by pressing the "Keyboard"  icon.

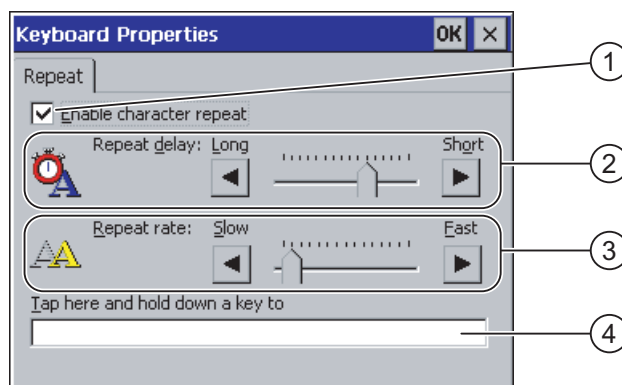

- ① Check box for activating the character repeat
- ② Slider control and buttons for the delay time before character repeat
- ③ Slider control and buttons for the rate of the character repeat
- ④ Test field

Procedure

Proceed as follows:

1. Activate the "Enable character repeat" check box to enable the character repeat.
2. Use the buttons to set the delay and rate of the character repeat. You can also use the slider control for this.
3. Verify your settings.
 - Touch the test field. The screen keyboard opens.
 - Move the screen keyboard as needed.
 - Touch any character and keep it pressed.
 - Check the implementation of the character repetition and the rate of the character repetition in the test field.
 - Correct your setting if necessary.
4. Confirm your entries.

The dialog closes.

Result

The character repeat for the screen keyboard has been altered.

6.3.3 Setting the Double-click

Introduction

You can start applications in the Control Panel and in Windows CE with a double-click. A double-click corresponds to two brief touches in sequence.

In the "Mouse Properties" dialog, you can set the time interval between the two touches of the touch screen.

Requirements

You have opened the "Mouse Properties" dialog box by pressing the "Mouse"  icon.

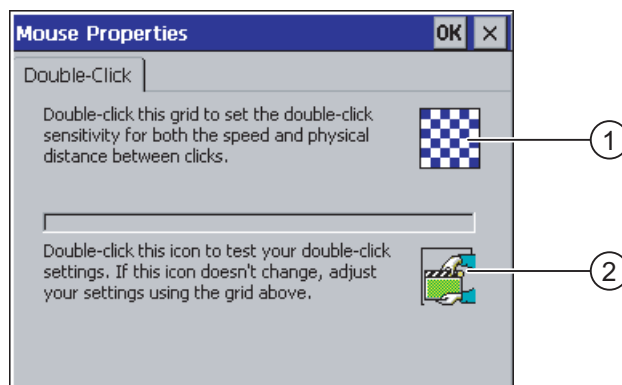

- ① Pattern
- ② Icon

Procedure

Proceed as follows:

1. Double-click the pattern twice.

After one double-click the pattern is shown in inverse colors.



2. Double-click the symbol twice.

If the double-click is valid, the icon is displayed as follows:



3. If the icon remains unchanged, double-click on the pattern again.
4. Confirm your entries.

The dialog closes.

Result

The double-click adjustment is completed.

6.3.4 Calibrating the Touch Screen

Introduction

Depending on the mounting position and viewing angle, it is possible that parallax may occur when operating the touch screen. In order to prevent any operating errors as a result, calibrate the touch screen again in the startup phase or during runtime.

Requirements

You have opened the "Touch" tab in the "OP Properties" dialog box by pressing the "OP"  icon.

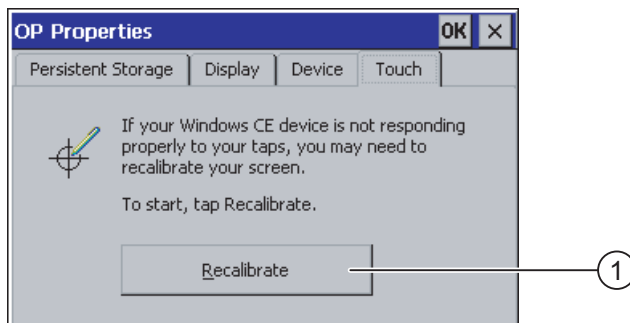

① Button for calibrating the touch screen

Procedure

Proceed as follows:

1. Touch the "Recalibrate" button to open the following dialog:

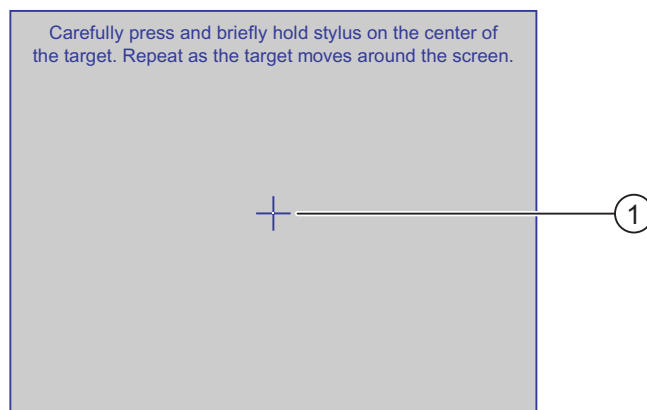

2. Briefly touch the middle of the calibration crosshairs ①.

The calibration crosshairs is then displayed at four more positions. Touch the middle of the calibration crosshairs for each position. If you do not touch the middle of the calibration crosshairs, the procedure is repeated.

Once you have touched the calibration crosshairs for all positions, the following dialog appears:

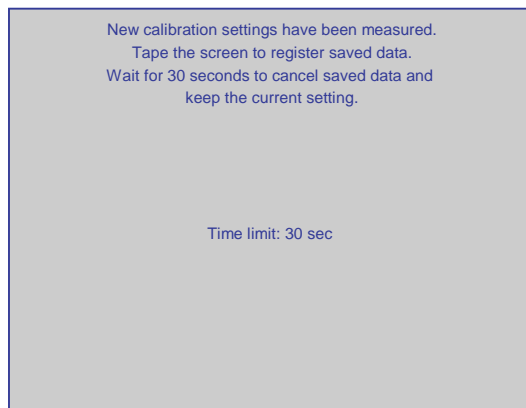

3. Touch the screen within 30 seconds.

The new calibration is saved. If you wait longer than 30 seconds, the new calibration is discarded and the original calibration remains in effect.

The "OP Properties" dialog , "Touch" tab is displayed again.

4. Close the dialog.

Result

The HMI device touch screen is now recalibrated.

6.4 Changing Password Protection

Introduction

You can protect the Control Panel and Windows CE taskbar with a password.

Requirements

You have opened the "Password Properties" dialog box by pressing the "Password"  icon.

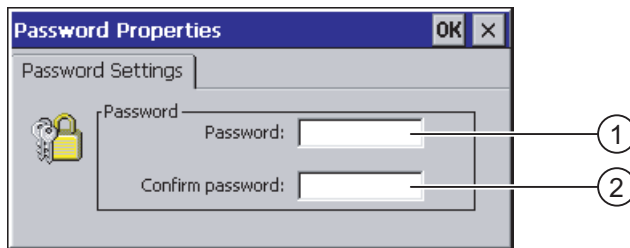

- ① Password text box
- ② Text box for entering the password a second time

NOTICE

If the password is no longer available, you cannot do the following until you have updated the operating system.

- Making changes to the Control Panel
- Operating the Windows CE task bar

All data on the HMI device will be overwritten when you update the operating system!

Procedure for activating password protection

Proceed as follows:

1. Enter a password in the "Password" text box.
2. Repeat the password entry in the "Confirm Password" text box.
3. Confirm your entries.

The dialog closes.

NOTICE

The following characters cannot be used in passwords:

- Blank
- Special characters * ? . % / \ ' "

Result

You cannot open the Control Panel or Windows CE taskbar without entering a password.

Procedure for deactivating password protection

Proceed as follows:

1. Delete the entries in the "Password" and "Confirm password" text boxes.
2. Confirm your entries.

The dialog closes.

Result

Password protection for the Control Panel and Windows CE taskbar is disabled.

6.5 Changing HMI device settings

6.5.1 Setting the date and time

Introduction

You can set the date and time on the HMI device. The HMI must be restarted in the following cases:

- You have changed the time zone setting.
- You have changed the "Daylight savings time currently in effect" check box setting.

Requirements

You have opened the "Date/Time Properties" dialog with the "Date/Time Properties"  icon.

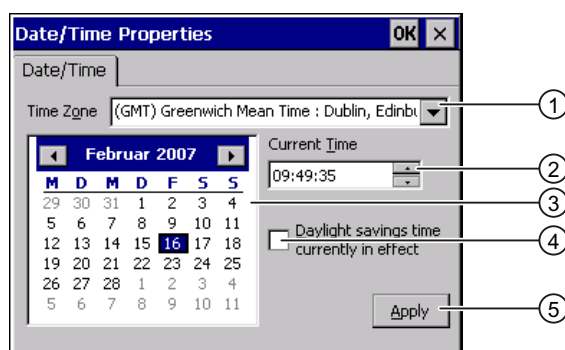

- ① Time zone selection box
- ② Text box for the time
- ③ Date selection box
- ④ "Daylight savings" check box
- ⑤ Button for applying changes

Procedure

Proceed as follows:

1. Select the appropriate time zone for the HMI device from the "Time Zone" selection box.
2. Touch the "Apply" button to confirm your entry.

The time of day shown in the "Current Time" box is adjusted correspondingly to the selected time zone.

3. Set the date in the selection field.
4. Set the current time of day in the "Current Time" input field.
5. Confirm your input by clicking on the "Apply" button.

The values you have set are now in effect.

Note

The system does not automatically switch between winter and summer time.

6. If you want to switch from winter to summer time, select the "Daylight savings time currently in effect" check box.

When you press the "Apply" button, the time is brought forward by one hour.

7. If you want to switch from summer to winter time, clear the "Daylight savings time currently in effect" check box.

When you press the "Apply" button, the time is taken backward by one hour.

8. Confirm your entries.

The dialog closes.

Result

The settings for the data and time of day have now been changed.

The HMI device must be restarted after changes in the following cases:

- You have changed the time zone setting.
- You have changed the "Daylight savings time currently in effect" check box setting.

Internal clock

The HMI device has an internal buffered clock.

Synchronizing the date and time with the PLC

The date and time of the HMI device can be synchronized with the PLC if this has been configured in the project and the PLC program.

Additional information on this subject is available in the "WinCC flexible" system manual.

NOTICE

Synchronizing the date and time

If the data and time is not synchronized and time-based reactions are triggered by the HMI device, malfunctions in the open-loop control may occur.

Synchronize the date and time if time-based reactions are triggered in the open-loop control.

See also

Restarting the HMI Device (Page 138)

6.5.2 Changing Regional Settings

Introduction

In different countries, for example, the date, time and decimal points are displayed differently. You can adjust the display format to meet the requirements of different regions.

The country-specific settings apply to the current project. If the project language is changed, the country-specific settings are also changed.

Requirements

You have opened the "Regional and Language Settings" dialog box by pressing the "Regional Settings"  icon.

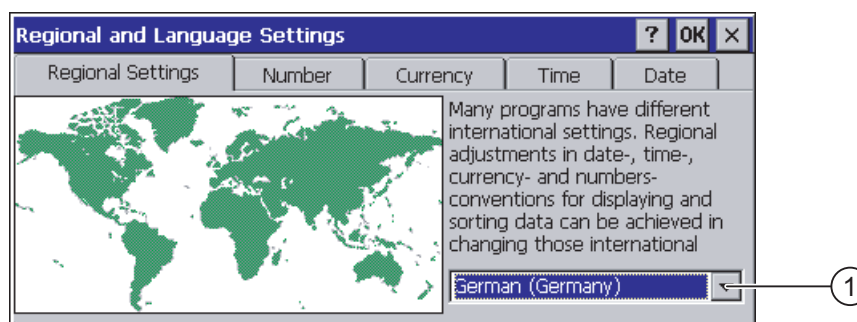

① Region selection box

Procedure

Proceed as follows:

1. Select the region from the selection box.
2. Change to the "Number", "Currency", "Time" and "Date" tabs and set the selection boxes to the desired settings.
3. Confirm your entries.
The dialog closes.

Result

The HMI device's regional settings have been changed.

6.5.3 Backing up Registry Information

Registry information and temporary data

You can install and uninstall your own programs on the HMI devices under Windows CE. You must save the registry settings after installation or uninstallation.

You can save the following data to the flash memory:

- Registry Information
- Temporary files

Restoring the file system of a memory card

If memory cards are used, the file system on the memory card may become damaged, perhaps due to a power failure. The HMI device detects the defective file system on start-up or when the memory card is inserted. The HMI device can restore the file system automatically or on request.

Requirements

You have opened the "Persistent Storage" tab in the "OP Properties" dialog box by pressing the "OP"  icon.

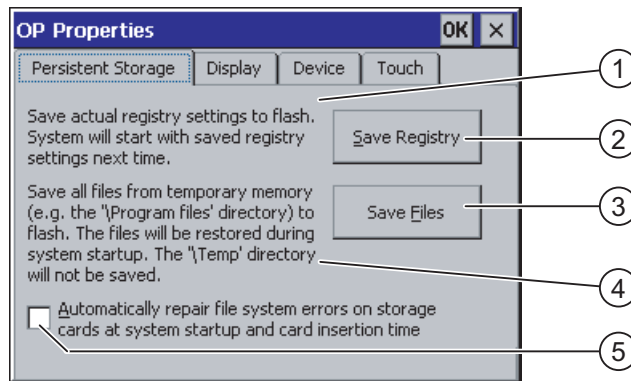

- ① Meaning of the text in the dialog:
Saves the current registry information to the flash memory. The HMI device loads the saved registry information the next time it boots.
- ② Button for saving registry information
- ③ Button for saving temporary files
- ④ Meaning of the text in the dialog:
Saves all the files in temporary storage to the flash memory (for example, from the "Program Files" directory). These files are written back when the HMI device is started. The "\Temp" directory is not saved.
- ⑤ Check box for automatically restoring the file system on the memory card when the HMI device starts up and when a memory card is inserted.

Procedure

Proceed as follows:

1. Select the "Save Registry" button to save the current registry settings.
2. Select the "Save Files" button to save temporary files.
3. Specify how the file system on the memory card should be restored.
 - Activate the check box "Automatically Repair ..." to activate automatic restore.
 - Deactivate the check box "Automatically Repair ..." if you wish to have the files system restored only upon prompting.
4. Confirm your entries.
The dialog closes.

Result

The HMI device uses the saved registry information the next time it starts. The temporary files are copied back.

6.5.4 Changing Screen Settings

Requirements

You opened the "Display" tab in the "OP Properties" dialog box by pressing the "OP"  icon.
icon.

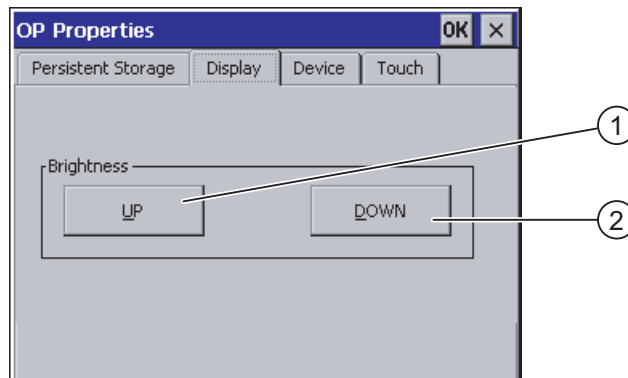

- ① Button for increasing the brightness
- ② Button for reducing the brightness

Procedure

Proceed as follows:

1. Press the "UP" button to increase the screen brightness. You can also reduce the screen brightness by pressing the "DOWN" button.
2. Confirm your entries.
The dialog closes.

Result

The screen settings have been changed.

Other possible settings

If configured, you can also set the brightness as follows:

- Within an opened project, by means of the configured control object
- Via the PLC

Additional information on this topic may be available in your plant documentation.

6.5.5 Setting the screen saver

Introduction

You can set the following time intervals on the HMI device:

- For the automatic activation of the screen saver
- For the automatic reduction in the screen's backlighting

When you do not undertake an operation within the configured interval, the configured function will be activated automatically.

The screen saver and the reduced screen backlighting functions are switched back off by means of the following actions:

- By pressing any key
- By touching the touch screen

The function associated to the key or button will not be executed by this.

NOTICE

Deterioration of the backlight brightness

The brightness of the backlighting decreases incrementally during its operational life. In order to increase the operational lifetime of the backlighting, activate the backlighting reduction.

Burn-in effects

The prolonged display of screen contents can occasionally lead to a burn-in effect in the background.

This burn-in effect automatically disappears after a certain amount of time, for example, after the screensaver was activated. The longer the same content is displayed on the screen, the longer it will take for the burn-in effect to disappear.

Generally, you should always activate the screen saver.

When the screen saver is active, the backlighting is reduced at the same time.

Requirements

You have opened the "Screensaver" dialog box by pressing the "ScreenSaver"  icon.

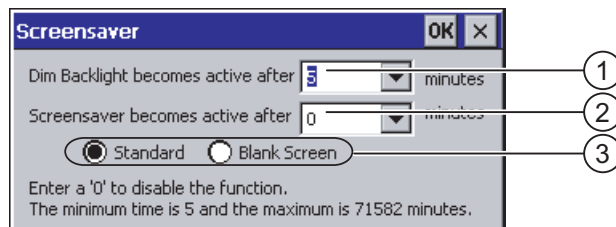

- ① Time interval in minutes until backlighting is reduced
- ② Period of time in minutes before the screen saver is activated
- ③ Screen saver setting

Procedure

Proceed as follows:

1. Enter the interval in minutes after which the backlighting is to be reduced.
Entering "0" will deactivate the backlighting reduction.
2. Enter the number of minutes before the screen saver is to be activated.
The minimum time is 5 minutes and the maximum time is 71582 minutes.
Entering "0" disables the screen saver.
3. Select either the standard screen saver or an empty screen.
 - In order to select the standard screen saver, activate the "Standard" option.
 - In order to select an empty screen as screen saver, activate the "Blank Screen" option.
4. Confirm your entries.
The dialog closes.

Result

The screen saver and the reduced backlighting for the HMI device is set.

6.5.6 Changing the Printer Properties

Introduction

HMI devices that are connected via PROFINET can print via a network printer.

You can print hardcopies and reports on a network printer. Line printing of alarms is not possible on a network printer.

The list of current printers and required settings for HMI devices can be found on the Internet under "<http://support.automation.siemens.com/WW/view/en/11376409>".

Requirements

You have opened the "Printer Properties" dialog box by pressing the "Printer"  icon.

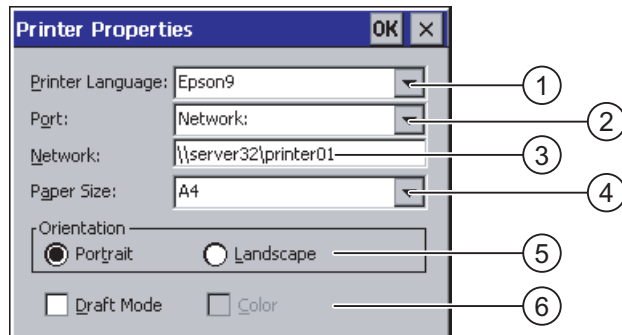

- ① Printer selection field
- ② Interface
- ③ Network address of the printer
- ④ Paper size selection field
- ⑤ Orientation setting
- ⑥ Print quality setting

Procedure

Proceed as follows:

1. Select the printer in the "Printer Language" selection field.
2. From the "Port" selection field, select the "Network:" interface.
3. Enter in the field "Network:" the network address of the printer.
4. Select the paper format in the "Paper Size" selection field.
5. Activate the required radio button in the "Orientation" group:
 - "Portrait" for vertical format
 - "Landscape" for horizontal format
6. Select the print quality.
 - Select the check box "Draft Mode" if you wish to print a draft.
 - Deactivate the check box "Draft Mode" if you wish to print with higher quality.
7. Set the color mode.
 - Select the check box "Color" if you wish to print in color.
8. Confirm your entries.

The dialog closes.

Result

The settings for the printer have now been changed.

6.5.7 Restarting the HMI Device

Introduction

The HMI device must be restarted in the following cases:

- You have activated or deactivated the PROFINET IO direct keys
- You have changed the time zone setting.
- You have changed the automatic daylight savings and standard setting

 CAUTION
Data loss when the HMI device is restarted All volatile data is lost when the HMI device is rebooted. Check the following: <ul style="list-style-type: none">• The project on the HMI device is not open• No data is being written to the flash memory

Requirements

You have opened the "OP Properties" dialog box by pressing the "OP" icon.

Procedure

1. Change to the "Device" tab in the "OP Properties" dialog.
2. Press "Reboot" to restart the HMI device.

A warning is displayed.

The HMI device reboots immediately if you confirm this warning.

Result

The HMI device starts.

See also

Setting the date and time (Page 129)

Enabling PROFINET IO (Page 148)

6.5.8 Displaying Information about the HMI Device

Introduction

You need the device-specific information when contacting Technical Support.

Requirements

You have opened the "Device" tab in the "OP Properties" dialog box by pressing the "OP"  icon.

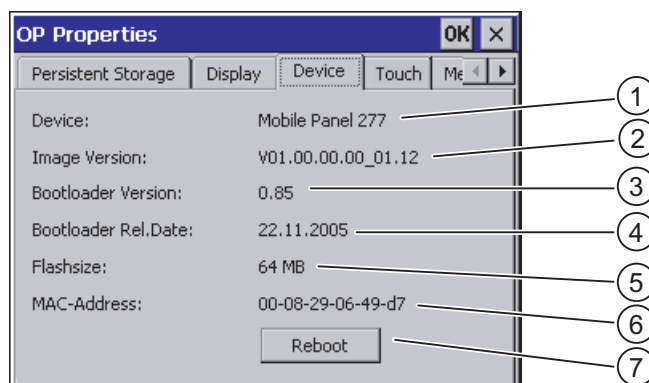

- ① HMI device name
- ② Version of the HMI device image
- ③ Version of the boot loader
- ④ Boot loader release date
- ⑤ Size of the internal flash memory in which the HMI device image and project are stored
- ⑥ MAC address of the HMI device
- ⑦ Button for restarting the HMI device

Procedure

Proceed as follows:

1. The device-specific information is displayed in the "Device" tab.
2. Close the dialog when the information is no longer required.

Note

The size of the internal flash memory does not correspond to the available working memory for a project.

6.5.9 Displaying System Properties

Introduction

The system-specific information provides you with information about the processor, operating system and memory of the HMI device.

Requirements

You have opened the "System Properties" dialog box by pressing the "System"  icon.

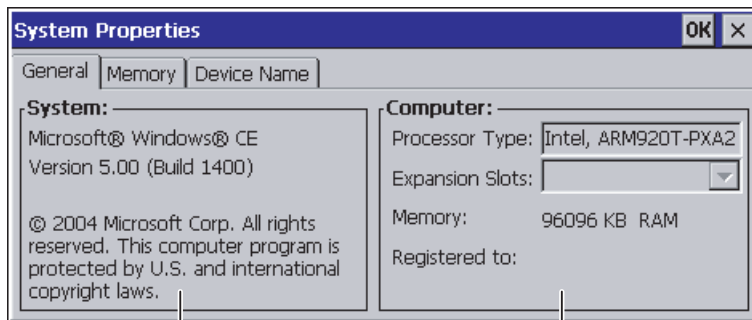

- ① Copyright to Microsoft Windows CE
- ② Information about the processor, size of the internal flash memory, and capacity of a memory card when inserted

Displaying the system information

The system information is displayed. This dialog is read-only.
Close the dialog.

Procedure for displaying memory information

NOTICE
"Memory" tab Do not change the memory distribution in the "Memory" tab. Only applies for the usage of options: An alteration to the memory distribution may be necessary. Please refer to the accompanying documentation for further information.

Proceed as follows:

1. Change to the "Memory" tab.

The memory information is displayed.

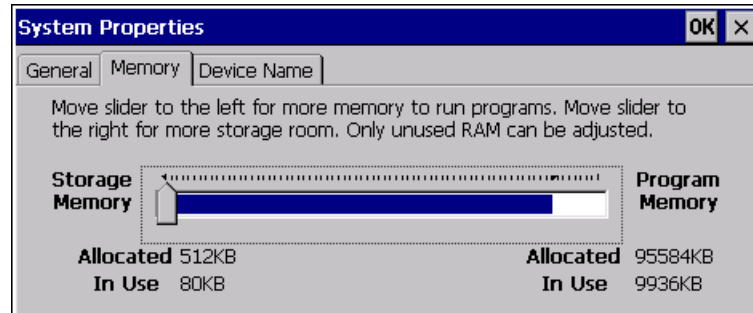

2. Close the dialog.

6.6 Setting the Delay Time

Introduction

The project is opened following a delay time when the HMI device is switched on. The Loader is displayed during the delay time.

Requirements

You have opened the "Directories" tab in the "Transfer Settings" dialog box by pressing the "Transfer"  icon.

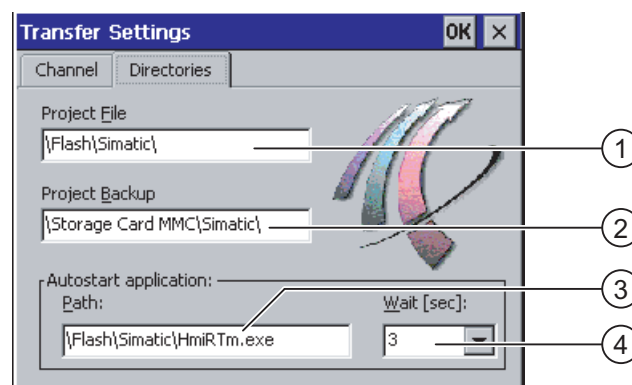

- ① Directory where the project file is saved
- ② Directory where the compressed source file of your project is saved
The external memory card or the network connection can be defined as the storage location. During the next backup process, the project's source file is stored in the specified location.
- ③ Storage location and initialization file of the HMI device for process operation
- ④ Region selection box

NOTICE
Settings in "Project File" and "Path" Do not change the setting in the "Project File" and "Path" fields. The project may not open at the next start of the HMI device if changes are made here.

Procedure for setting the delay time

1. Select the desired delay time in seconds in the "Wait [sec]" selection box.
With the value "0", the project starts immediately. It is then no longer possible to call the Loader after switching on the HMI device. If you still wish to access the Loader, an operating element must be configured to close the project.
2. Confirm your entries.
The dialog closes.

Result

The delay time for the HMI device is now set.

6.7 Communication settings

6.7.1 Changing MPI/PROFIBUS DP Settings

Introduction

The communication settings for MPI or PROFIBUS DP are defined in the HMI device project. In the following cases, the communication settings might have to be changed:

- The first time the project is transferred
- If changes are made to the project but are only applied later

NOTICE

Transfer mode using MPI/PROFIBUS DP

The bus parameters are read from the project currently loaded on the HMI device.

The settings for MPI/PROFIBUS DP transfer can be modified. The following steps are required:

- Close the project.
- Change the settings on the HMI device.
- Then return to "Transfer" mode.

The changed MP/PROFIBUS DP settings will be overwritten in the following cases:

- The project is started again
- A project is transferred

Transfer settings

A project can only be transferred from the Configuring PC to the HMI device when at least one of the data channels is enabled on the HMI device.

If the HMI device is in "Transfer" mode while changes are made to the transfer settings, the settings only go into effect after the transfer function is restarted.

Requirements

You have opened the "S7-Transfer Settings" dialog box by pressing the "S7-Transfer Settings"  icon.

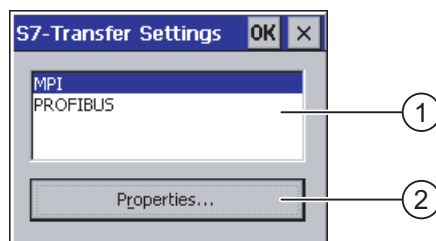

- ① Network selection
- ② Button for opening the properties dialog

Procedure

Proceed as follows:

1. Select a network.
2. Open the "MPI" or "PROFIBUS" dialog with the "Properties" button:

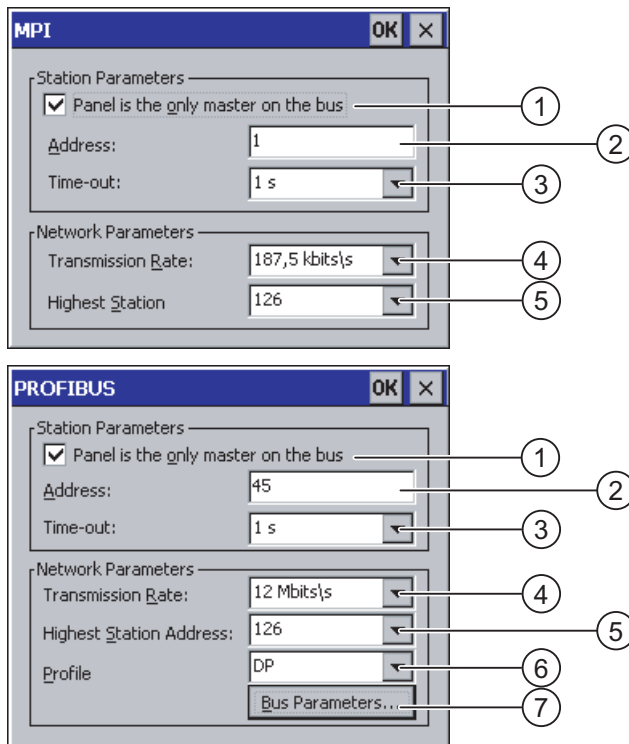

- ① The HMI device is the only master on the bus.
- ② Bus address of the HMI device
- ③ Time-out
- ④ Data transmission rate in total network
- ⑤ Highest station address in the network
- ⑥ Profile
- ⑦ Button for displaying the bus parameters

3. If more masters are connected to the bus, deactivate the check box "Panel is the only master on the bus".
4. Enter the bus address for the HMI device in the "Address" text box.

NOTICE

The bus address in the "Address" text box must be unique throughout the MPI/PROFIBUS DP network.

5. Select the transmission rate in the "Transmission Rate" text box.
6. Select the highest station address on the bus in the "Highest Station Address" or "Highest Station" text box.
7. Select the desired profile from the "Profile" selection box.

- The profile information is displayed when you select "Bus Parameters" button in the PROFIBUS dialog. The "Profile" dialog is read-only.

NOTICE

The bus parameters must be the same for all stations in the MPI/PROFIBUS DP network.

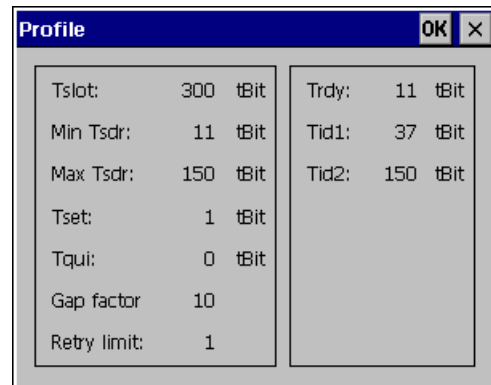

- Close the "Profile" dialog.
- Confirm your entries in the "MPI" or "PROFIBUS" dialog.
The dialog closes.

Result

The MPI/PROFIBUS DP settings of the HMI device have been changed.

6.7.2 Configuring the data channel

Introduction

If you block all data channels, the HMI device is protected against unintentional overwriting of the project data and HMI device image.

Note

A project can only be transferred from the configuring PC to the HMI device when at least one of the data channels is enabled on the HMI device.

Requirements

You have opened the "Transfer Settings" dialog box by pressing the "Transfer Settings" icon.

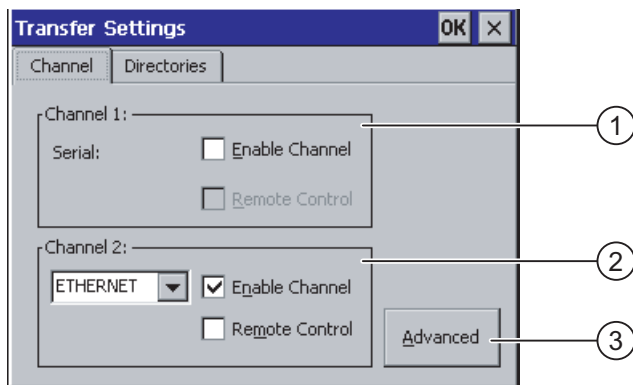

- ① Group for data channel 1 (Channel 1)
- ② Group for data channel 2 (Channel 2)
- ③ Button for the dialog "MPI/DP Transfer Settings" or "Network and Dial-Up Connections."

Note

"Remote Control" for channel 1

Only select the "Remote Control" check box in the "Channel 1" group, if serial transfer is in progress. Clear the check box before changing to "Online" mode.

Procedure

Proceed as follows:

1. You can clear the required data channel by activating the associated "Enable Channel" check box in the "Channel 1" or "Channel 2" group.
In the "Channel 1" group, the RS-422/RS-485 port is configured for the serial data transfer.
 - Activate the "Enable Channel" check box to enable the data channel.
 - Deactivate the "Enable Channel" check box to lock the data channel.
2. Enable automatic transfer by activating the respective "Remote Control" check box in the "Channel 1" or "Channel 2" group.

 WARNING
--

Unintentional transfer mode

Ensure that the configuring PC does not inadvertently switch the HMI device to transfer mode during the open project. This could cause unintentional actions to be triggered in the plant.
--

3. Select the required protocol for "Channel 2" in the selection box.
4. Enter further parameters if required.
 - Applies to "MPI/PROFIBUS DP":

Press the "Advanced" button to change to the "S7-Transfer Settings" dialog box. You can change the settings for MPI/PROFIBUS DP there.

Confirm your entries.

The "S7-Transfer Settings" dialog box closes.
 - Applies to "ETHERNET":

Press the "Advanced" button to change to the "Network&Dial-Up Connections."

Open the "LAN9001" entry. You can change the TCP/IP settings there.

Confirm your entries.

Close "Network&Dial-Up Connections".
 - Applies to "USB:"

No further settings are required for "USB".
5. Confirm your entries.

The dialog closes.

Result

The data channel is configured.

General information

Note

Changes during "Transfer" mode

If the HMI device is in "Transfer" mode while changes are made to the transfer settings, the settings only go into effect after the transfer function is restarted.

This may occur if the Control Panel is opened to change the transfer properties in an active project.

NOTICE

Transfer mode via channel 2

The bus parameters, for example address of the HMI device, are read out of the project that is currently running on the HMI device.

You can change the settings for the transfer via channel 2.

The following steps are required:

- Close the project.
- Change the settings on the HMI device.
- Then return to "Transfer" mode.

The next time the project is started on the HMI device, the settings will be overwritten by the values from the project.

See also

Changing MPI/PROFIBUS DP Settings (Page 143)

Changing the Network Configuration (Page 152)

6.7.3 Enabling PROFINET IO

PROFINET IO

If the HMI device is connected to the PLC via PROFINET, function keys or buttons, for example, can be configured as PROFINET IO direct keys. If PROFINET IO direct keys are used in the project, they must be enabled.

Note

If you enable PROFINET IO direct keys, you cannot use the RS 422/RS 485 port for serial communication.

PROFINET IO direct keys and PROFIBUS DP direct keys are mutually exclusive.

Requirements

You have opened the "PROFINET" dialog with the "PROFINET"  button.

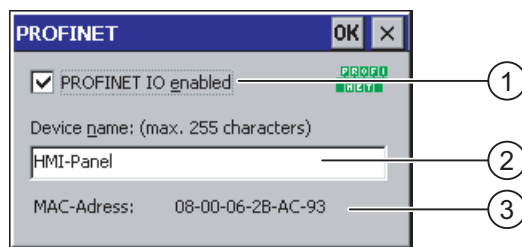

- ① Check box for enabling or locking the PROFINET IO direct keys
- ② Text box for the device name
- ③ MAC address of the HMI device

Procedure

1. Select the "PROFINET IO enabled" check box to enable PROFINET IO direct keys.
2. Enter the device name of the HMI device.

NOTICE

The device name must match the device name entered in the HW Config of STEP 7. This device name is not the device name under Windows CE.

3. Confirm your entries.
The dialog closes.
4. Reboot the HMI device after saving the settings.

Result

The PROFINET IO direct keys are enabled.

See also

Restarting the HMI Device (Page 138)

6.8 Configuring network operation

6.8.1 Overview of network operation

Introduction

You can connect the HMI device to a PROFINET network via the Ethernet port. The connection to a network offers, for example, the following options:

- Printing via a network printer
- Saving, exporting and importing of recipe data records on or from a server
- Setting up of message and data archives
- Transferring a project
- Saving data

NOTICE
The HMI device can only be used in PROFINET networks. The HMI device only has client functionality in the PC network. This means that users can access files of a node with TCP/IP server functionality from the HMI device via the network. However, you cannot, for example, access data on the HMI device from a PC via the network.

Note

Information on communication using SIMATIC S7 via PROFINET is provided in the "WinCC flexible communication" user manual.

Addressing

Within a PROFINET network, computers are usually addressed using computer names. These computer names are translated from a DNS or WINS server to TCP/IP addresses. This is why a DNS or WINS server is needed for addressing via computer names when the HMI device is in a PROFINET network.

The corresponding servers are generally available in PROFINET networks.

Note

The use of TCP/IP addresses to address PCs is not supported by the operating system.

Consult your network administrator if you have questions in this regard

Printing via a network printer

The HMI device's operating system does not support line by line alarm logging via a network printer. All other printing functions, for example hardcopy or logs are available without restriction via the network.

Preparation

Before beginning the configuration, request the following network parameters from your network administrator.

- Does the network use DHCP for dynamic assignment of network addresses?
If not, get a new TCP/IP network address for the HMI device.
- Which TCP/IP address does the default gateway have?
- If a DNS network is used, what are the addresses of the name server?
- If a WINS network is used, what are the addresses of the name server?

General procedure for configuring the network

The HMI device must be configured prior to network operation. The configuration is basically divided into the following steps:

Proceed as follows:

1. Enter the computer name of the HMI device.
2. Configure the network address.
3. Set the logon information.
4. Save the settings.

6.8.2 Setting the device name of the HMI device

Introduction

The HMI device uses the device name to identify itself in the network.

Requirements

You have opened the "System Properties" dialog box by pressing the "System"  icon.

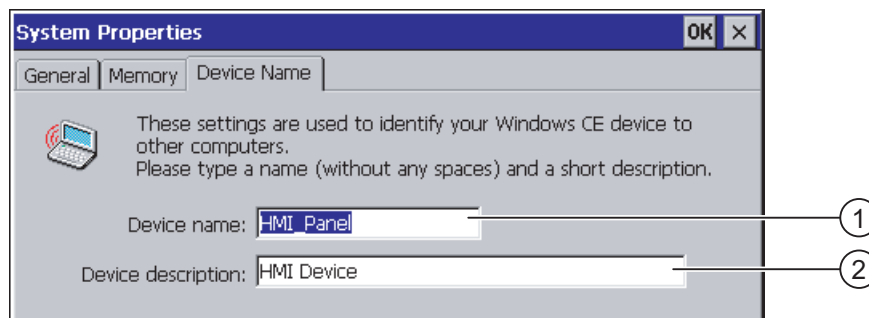

- ① Device name of the HMI device
- ② Description for the HMI device (optional)

Note

Change the device name for the HMI device in the "Device name" text box to activate the network functions.

Procedure

Proceed as follows:

1. Enter the device name for the HMI device in the "Device name" text box.
2. Enter a description for the HMI device in the "Device description" text box.
3. Confirm your entries.

The dialog closes.

Result

The device name for the HMI device is now set.

See also

Overview of network operation (Page 149)

6.8.3 Changing the Network Configuration

Overview

You can change the network settings for the LAN connection under "Network & Dial-Up Connections".

Requirement - changing LAN connection settings

You have pressed the "Network&Dial-Up Connections"  icon to open the following view.



Procedure

Proceed as follows:

1. Open the "LAN90001" entry.
 - The "'SMC LAN91C111 Ethernet' Settings" dialog opens.

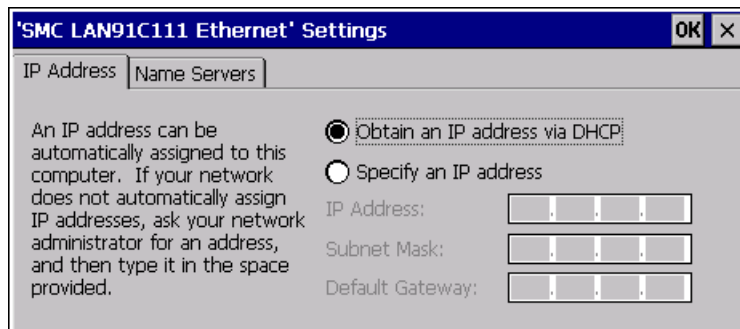

2. Select either automatic address assignment via DHCP or manual address assignment.
3. If you assign the address manually, enter the respective addresses in the text boxes for "IP Address", "Subnet Mask" and, if used, "Default Gateway".
4. If a name server is used in the network, change to the "Name Servers" tab.

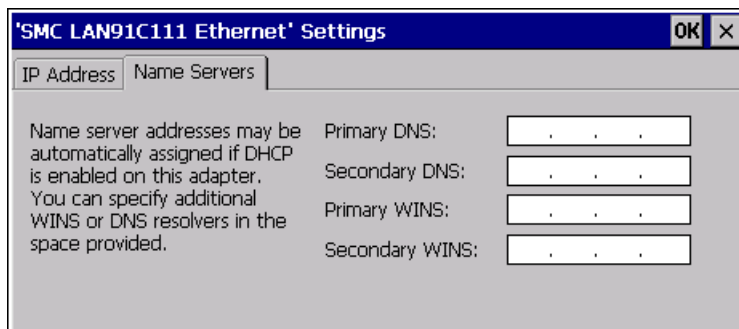

5. Enter the respective addresses in the text boxes.

6. Confirm your entries.
The dialog closes.
7. Close the "Network&Dial-Up Connections" view.
The Control Panel is displayed again.

Result

The LAN connection parameters for the HMI device have been changed.

See also

Overview of network operation (Page 149)

6.8.4 Changing the Logon Data

Introduction

Windows CE uses this information to gain access to the network resources. Enter the user name, password and domain you have received from your administrator.

Requirements

You have opened the "Network ID" dialog box by pressing the "Network ID"  icon.

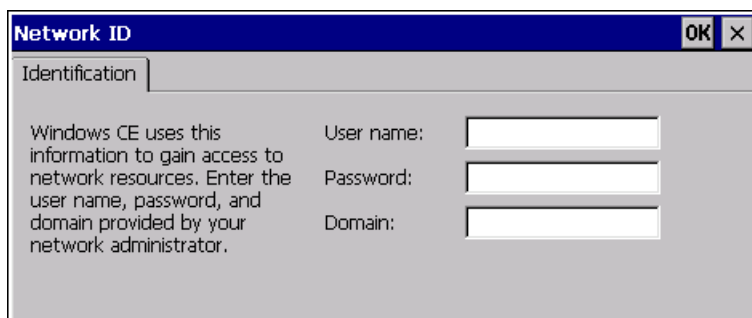

Procedure

Proceed as follows:

1. Enter the user name in the "User name" text box.
2. Enter your password in the "Password" text box.
3. Enter the domain name in the "Domain" text box.
4. Confirm your entries.

The dialog closes.

Result

The logon information has now been set.

See also

Overview of network operation (Page 149)

6.8.5 Changing E-Mail Settings

Requirements

You have opened the "WinCC flexible Internet Settings" dialog box by pressing the "WinCC Internet Settings"  icon.

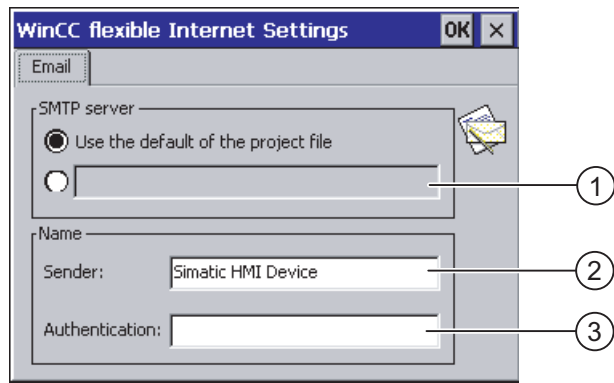

- ① Setting the SMTP server
- ② Name for the sender
- ③ E-mail account

Note

Options

Additional tabs may appear in the "WinCC flexible Internet Settings" tab. This depends on the options that have been enabled for network operation in the project.

Procedure for changing e-mail settings

Proceed as follows:

1. Specify the SMTP server.
 - Activate the "Use the default of the project file" radio button if you want to use the SMTP server configured in the project.
 - Deactivate the "Use the default of the project file" radio button if you do not want to use the SMTP server configured in the project.
 - Specify the required SMTP server.
2. Enter the name for the sender in the "Sender" text box.
3. Enter the e-mail account for your e-mail in the "Authentication" text box.

Some e-mail providers only allow you to send mail if you specify the e-mail account. The "Authentication" text box can remain empty if your e-mail provider allows you to send mail without checking the account.

4. Confirm your entries.

The dialog closes.

Result

The e-mail settings have been changed.

See also

Overview of network operation (Page 149)

6.8.6 Changing internet settings

6.8.6.1 Changing General Internet Settings

Requirements

You have opened the "General" tab in the "Internet Options" dialog box by pressing the

"Internet Options"  icon.

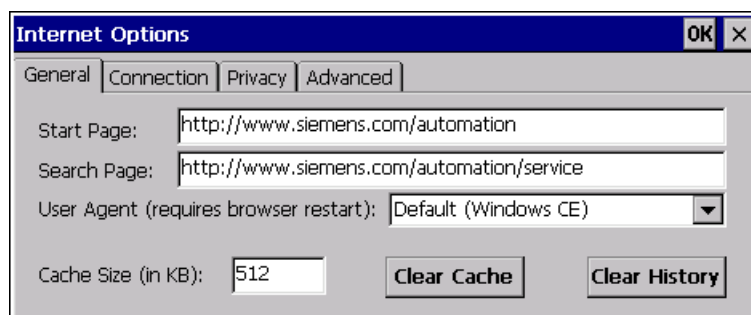

Note

Do not change the settings in the "User Agent" field.

Procedure

Proceed as follows:

1. Enter the required start page for the browser in the "Start Page" text box.
2. Enter the address of the required search engine in the "Search Page" field.
3. Enter the required cache memory size in the "Cache" text box.
4. The cache can be deleted by means of the "Clear Cache" button.
5. The history can be deleted by means of the "Clear History" button.
6. Confirm your entries.
The dialog closes.

Result

The general parameters for the Internet browser have been set.

6.8.6.2 Setting the Proxy Server

Requirements

You have opened the "Connection" tab in the "Internet Options" dialog box by pressing the "Internet Options"  icon.

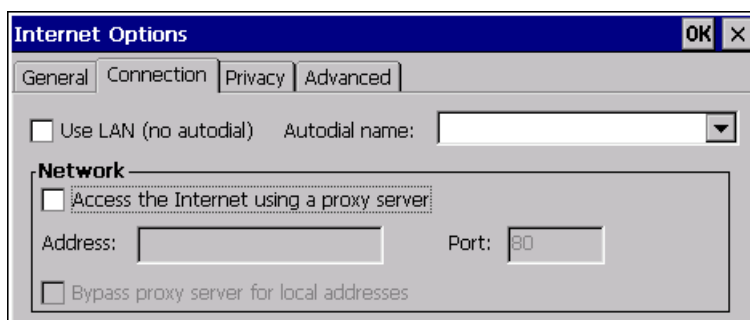

Procedure

Proceed as follows:

1. Activate the "Use LAN (no autodial)" check box.
2. If you use a proxy server, activate the "Access the Internet using a proxy server" check box in the network group.

Specify the address of the proxy server and the port.

Note

The proxy settings in the Control Panel apply to all applications that are running on the HMI device.

The Pocket Internet Explorer requires independent proxy settings that you must specify in the properties of the Pocket Internet Explorer. See chapter Loader (Page 115).

3. If you want to bypass the proxy server for local addresses, activate the "Bypass proxy server for local addresses" checkbox.
4. Confirm your entries.

The dialog closes.

6.8.6.3 Changing Privacy Settings

Cookies and encryption

Cookies are pieces of information sent by a web server to a browser. In the event of subsequent access to the web server, the cookies are sent back. This enables information to be stored between the accesses.

In order to ensure a high level of privacy, data are sent via the Internet in encrypted form. Common encryption protocols include SSL and TLS. You can activate or deactivate the usage of encryption protocols.

The required settings can be obtained from your network administrator.

Requirements

You have opened the "Privacy" tab in the "Internet Options" dialog box by pressing the

"Internet Options"  icon.

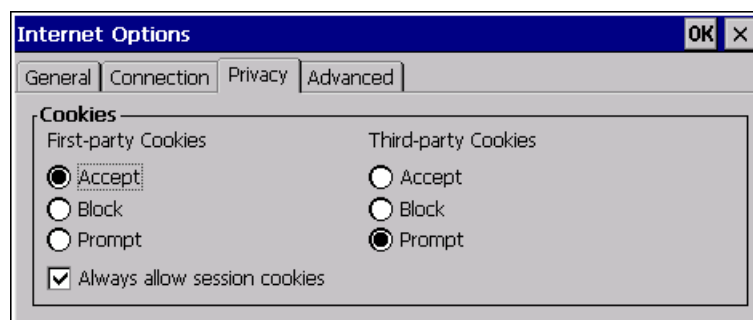

Procedure

Proceed as follows:

1. Select the required cookie behavior by means of the option buttons.
 - "Accept"
Cookies are stored without request.
 - "Block"
Cookies will not be stored.
 - "Prompt"
Cookies will be stored on request.
2. If you want allow cookies which are restricted to a single session, activate the "Always allow session cookies" checkbox.
3. Change to the "Advanced" tab.

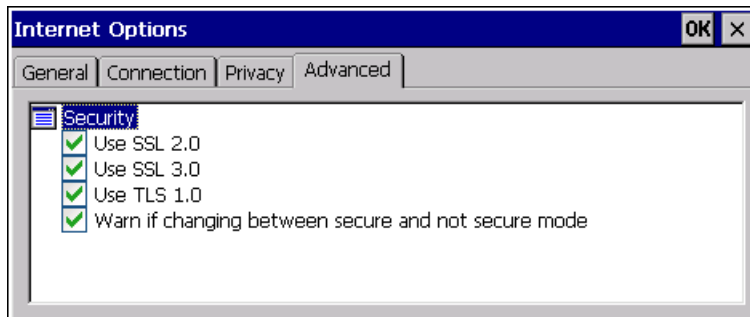

4. Activate the required encryption protocol.
5. Confirm your entries.
The dialog closes.

Result

The logon information has now been set.

6.8.6.4 Importing and Deleting Certificates

Overview

You can import, view and delete certificates that have been imported for the HMI device. The certificates differ in the following ways:

- Certificates that you trust
- Own certificates
- Other certificates

You can import additional certificates and delete certificates that are not required.

The required settings can be obtained from your network administrator.

Requirements

You have opened the "Certificates" dialog box by pressing the "Certificates"  icon.



Procedure

Proceed as follows:

1. Select the type of certificate from the selection box:
 - "Trusted Authorities"
 - "My Certificates"
 - "Other Certificates"
2. You can start the import by pressing the "Import" button.
A dialog with source details will open.
3. If required, delete the certificate.
 - Mark the desired certificate.
 - Delete the selected certificate by pressing the "Remove" button.
4. Press the "View" button to list the properties of the selected certificate.
5. Close the dialog.

Result

The changes to the certificates have been undertaken.

6.9 Backup and Restore with the Memory Card

Introduction

Backup involves copying the operating system, applications and data from the internal flash memory of the HMI device to a memory card.

A restore operation deletes the old data from flash memory of the HMI device on confirmation. The data stored on the memory card is then copied to the internal flash memory.

CAUTION

All data on the HMI device will be deleted during a restore operation. Existing licenses are retained.

Requirements

A memory card with sufficient free capacity is inserted in the HMI device. The size of the internal flash memory is displayed with information about the HMI device. A warning is displayed if the available space is insufficient and backup is aborted.

You have opened the "Backup/Restore" dialog box by pressing the "Backup/Restore"  icon.

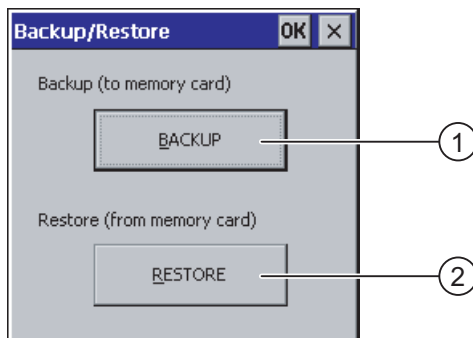

- ① Button for backup to memory card
- ② Button for restore from memory card

Procedure for backup

Proceed as follows:

1. Press the "BACKUP" button to start the backup.
2. The HMI device checks the memory card.
If no memory card is inserted in the card slot of the HMI device or if the memory card is damaged:
 - The following warning is displayed:
"No storage card detected!"
 - Acknowledge the warning and the next message "Backup aborted."
The Control Panel is displayed again.A message is displayed if the memory card already contains data. Follow the instructions of the HMI device.
3. The following messages and dialogs are displayed in sequence during backup.
 - "Checking Registry"
 - "Backup Progress"
 - "Saving CE-Image"A progress bar shows the status of the backup process.
4. If backup was successful, the following message is displayed:
"Backup successfully completed. Press OK and remove your storage card."
5. Press the "OK" button to confirm the message.
Remove the memory card.

Result

The HMI device data is now saved on the memory card.

Requirements

The memory card with the backup is inserted in the HMI device.

Procedure for restore

Proceed as follows:

1. Press the "RESTORE" button run the restore operation.
The HMI device checks the memory card.
2. If no memory card is inserted in the card slot of the HMI device or if the memory card is damaged:
 - The following warning is displayed:
"Storage card couldn't be detected. Try restore again? Insert storage card and Press 'OK' or abort restore with 'CANCEL'."
 - Replace the faulty memory card and restart the restore operation by pressing the "OK" button.
3. The data to be restored is checked.
The following messages are displayed in sequence during the check.
 - "Starting Restore"
 - "Checking data".
4. When the data has been checked, the following prompt for confirmation is displayed:
"You are starting RESTORE now. All files (except files on storage cards) and the registry will be erased. Are you sure?"
At this point you can abort the restore if required in order to prevent the data on the HMI device from being deleted.
5. Start to restore the data by pressing the "Yes" button.
The following messages are displayed in sequence during the restore:
 - "Deleting files on flash"
 - "Restore CE Image"A progress bar shows the status of the restoration of the Windows CE image.
6. After successful restoration of the Windows CE image, the following message is displayed: "Restore of CE Image is finished. The device will be rebooted now. Don't remove the storage card."
Acknowledge this message.
7. The HMI device starts. The operating system boots, opening the "Loader" and "Restore" dialog in sequence.
8. The restore process is resumed. All data stored on the flash file system is restored. Afterwards the following message is displayed "Restore succesfully finished. Press ok, remove your storage card and reboot your device."
Remove the memory card.
Acknowledge this message.
9. The HMI device starts.

Result

The data from the memory card is now on the HMI device.

See also

Displaying Information about the HMI Device (Page 139)

6.10 Display rechargeable battery charge level

Introduction

The rechargeable battery is an optional accessory. The "OP Properties" dialog, "Accu" tab displays the remaining capacity and temperature of the rechargeable battery.

Requirements

You have opened the "Accu" tab in the "OP Properties" dialog box by pressing the "OP"  icon.

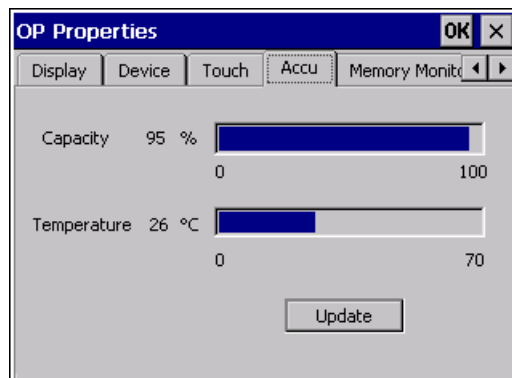

Procedure

Proceed as follows:

1. You can refresh the view by pressing the "Update" button.
2. Close the dialog.

6.11 Activate Memory Management

Memory management

If reorganization of the memory is required during the runtime of project, the HMI device can shut down the project autonomously.

The project is shut down and the HMI device will display a message. You have to restart the project.

NOTICE

If you do not activate memory management, undefined states can occur during the runtime of the project.

Requirements

You have opened the "Memory Monitoring" tab in the "OP Properties" dialog box by pressing the "OP"  icon.

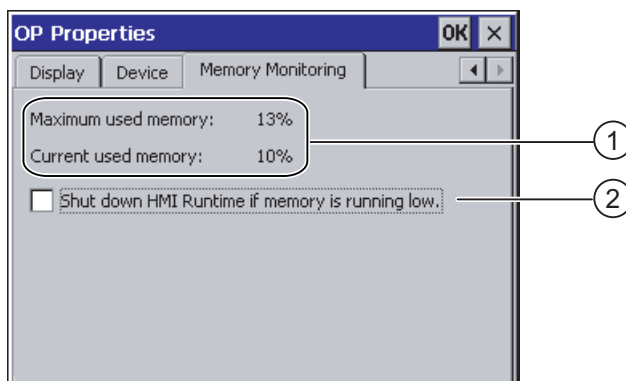

- ① The maximum used memory since last power on of the HMI device and the current used memory in percent.
- ② Control box for activation of memory management

Procedure

Proceed as follows:

1. In order to start memory management, activate the control box.
2. Confirm your entries.

The dialog closes.

Result

Memory management is activated.

Commissioning a project

7.1 Overview

Configuration and process control phase

HMI devices can be used to operate and monitor tasks in process and production automation. The plant screens on the HMI devices are used to provide a clearer overview of active processes. The HMI device project, which includes the plant screens, is created during the configuration phase.

Once the project is transferred to the HMI device, current processes can be operated and monitored in the process control phase. The HMI device is connected to a PLC in the plant and exchanges values with this PLC.

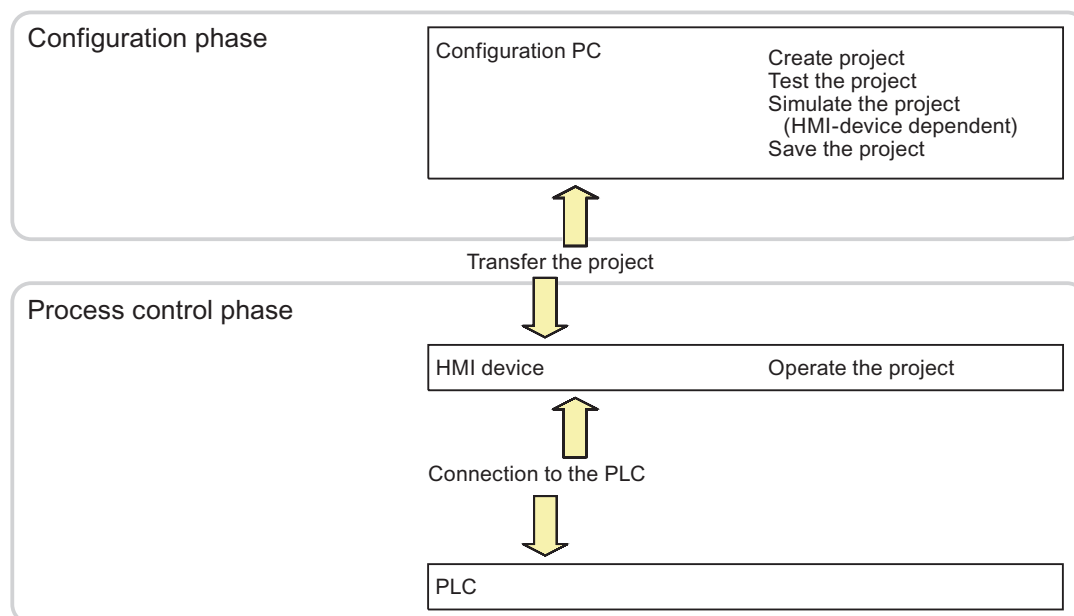

Transferring the project to the HMI device

You can transfer a project to an HMI device as follows:

- Transfer from the configuring PC
- Restore from a PC using ProSave

In this case, an archived project is transferred from a PC to the HMI device. The configuration software need not be installed on this PC.

Commissioning and recommissioning

- When the HMI device is commissioned there is no project at first.
The HMI device is also in this state after the operating system has been updated.
- When recommissioning, any project already on the HMI device is replaced.

7.2 Operating modes

Operating modes

The HMI device may be in the following operating modes:

- Offline
- Online
- Transfer

"Offline mode" and "Online mode" can be set on both the configuring PC and the HMI device. To set these modes on the HMI device, use a corresponding operating element of the project.

Changing the operating mode

The configuration engineer must have configured an appropriate operating element to allow a change of the operating mode on the HMI device during ongoing operation.

Further information on this may be available in your plant documentation

"Offline" operating mode

In this mode, there is no communication between the HMI device and PLC. Although the HMI device can be operated, it cannot exchange data with the PLC.

"Online" operating mode

In this mode, the HMI device and PLC communicate. You can operate the plant on the HMI device according to your system configuration.

"Transfer" mode

In this mode, you can transfer a project from the configuring PC to the HMI device or backup and restore HMI device data, for example.

The following options are available for setting "Transfer" mode on the HMI device:

- When the HMI device starts up

Start "Transfer" mode manually in the HMI device Loader.

- During ongoing operation

Start the "Transfer" mode manually within the project using an operating element. The HMI device toggles to "Transfer" mode when automatic mode is set and a transfer is initiated on the configuring PC.

7.3 Using existing projects

You can use existing projects from Mobile Panels 170 and 177.

The following cases are possible:

1. Old project exists in ProTool
Migrate the project to WinCC flexible and subsequently carry out an HMI device switch.
2. Old project exists in WinCC flexible
Carry out an HMI device switch in WinCC flexible.

Further information on the subject can be found in the WinCC flexible Online Help or in the "WinCC flexible Migration" manual.

7.4 Data Transmission Options

Overview

The following table shows the options for data transfer between Mobile Panel 277 and a configuring PC.

Type	Data channel	Mobile Panel 277
Backing up	Serial ¹⁾	Yes
	MPI/PROFIBUS DP	Yes
	USB	Yes
	Ethernet	Yes
Restoring	Serial ¹⁾	Yes
	MPI/PROFIBUS DP	Yes
	USB	Yes
	Ethernet	Yes
Updating the operating system	Serial, with reset to factory settings ^{1) 2)}	Yes
	Serial ¹⁾	Yes
	MPI/PROFIBUS DP	Yes
	USB	Yes
	Ethernet	Yes
Transferring a project	Serial ¹⁾	Yes
	MPI/PROFIBUS DP	Yes
	USB	Yes
	Ethernet	Yes
Installing or removing an option	Serial ¹⁾	Yes
	MPI/PROFIBUS DP	Yes
	USB	Yes
	Ethernet	Yes

Type	Data channel	Mobile Panel 277
License key transferring or transferring back	Serial ¹⁾	Yes
	MPI/PROFIBUS DP	Yes
	USB	Yes
	Ethernet	Yes

- 1) Applies when PC/PPI cable is used
- 2) Applies when the USB/PPI cable is used

7.5 Transfer

7.5.1 Overview

Transfer

Transfer the executable project from the configuring PC to the HMI device.

You can start the "Transfer" mode manually or automatically on the HMI device.

Transferred data is written directly to the internal flash memory on the HMI device. For the transfer, you use a data channel which you have to configure before starting a transfer.

Backtransfer

You have the option to transfer the compressed project file together with the runtime project to the HMI device. If necessary, the compressed project file can be transferred back to the configuring PC and edited.

The HMI device must be equipped with an external memory card to which the compressed project file can be saved.

NOTICE
Compressed project file WinCC flexible does not check whether the compressed project file stored on the HMI device corresponds to the existing runtime project.

7.5.2 Starting manual transfer

Introduction

You can manually switch the HMI device to "Transfer" mode as follows:

- With a configured operating element during ongoing operation.
- In the Loader of the HMI device.

Requirements

- The project "*.hmi" is opened in WinCC flexible.
- The HMI device is connected to a configuring PC
- The data channel is configured on the HMI device
- The HMI device is in "Transfer" mode

Procedure

Proceed as follows:

1. On the configuring PC, select the "Transfer settings" command in the menu "Project > Transfer" in WinCC flexible.
The "Select devices for transfer" dialog opens.
2. Select the HMI device in the left area of the dialog.
3. Select the type of connection between the HMI device and the configuring PC.
Set the connection parameters.
4. Set the transfer parameters in the right area of the dialog.
5. If you wish to transfer the compressed project file together with the runtime project to the HMI device:
Select the "Enable backtransfer" check box.
6. Start transfer in WinCC flexible with "Transfer".
The configuring PC checks the connection to the HMI device. The project is transferred to the HMI device. If the connection is not available or is defective, an error message is displayed on the configuring PC.

Result

When the transfer is completed successfully, the project can be found on the HMI device. The transferred project is then started automatically.

See also

- Operating modes (Page 166)
- Data Transmission Options (Page 167)
- Configuring the data channel (Page 145)
- Overview (Page 168)

7.5.3 Starting automatic transfer

Introduction

The HMI device can be automatically switched to "Transfer" mode during runtime as soon as transfer is started on the configuring PC connected.

Automatic transfer is particularly suited for the test phase of a new project since transfer is completed without interfering with the HMI device.

Automatic transfer is available for the following data channels:

- Serial
- MPI/PROFIBUS DP
- USB
- Ethernet

NOTICE
<p>If the automatic transfer has been activated on the HMI device and a transfer is initiated on the configuring PC, the project currently running is automatically stopped. The HMI device then automatically switches to "Transfer" mode.</p> <p>After the commissioning phase, deactivate the automatic transfer so that the HMI device cannot be inadvertently switched to transfer mode. The transfer mode can trigger unintentional actions in the device.</p> <p>You can set a password for the Loader of the HMI device to restrict access to the transfer settings and thus avoid unauthorized modifications.</p>

Requirements

- The project *.hmi is opened in WinCC flexible.
- The HMI device is connected to a configuring PC
- The data channel is configured on the HMI device
- The automatic transfer is activated in the data channel for the transfer.
- The project is started on the HMI device.

Procedure

Proceed as follows:

1. On the configuring PC, select the "Transfer settings" command in the menu "Project > Transfer" in WinCC flexible.
The "Select devices for transfer" dialog opens.
2. Select the HMI device in the left area of the dialog.
3. Select the type of connection between the HMI device and the configuring PC.
Set the connection parameters.
4. Set the transfer parameters in the right area of the dialog.
5. If you wish to transfer the compressed project file together with the runtime project to the HMI device:
Select the "Enable backtransfer" check box.
6. Start transfer in WinCC flexible with "Transfer".
The configuring PC checks the connection to the HMI device. The HMI device shuts down the current project and automatically switches to "Transfer" mode. The project is transferred to the HMI device. If the connection is not available or is defective, an error message is displayed on the configuring PC.

Result

When the transfer is completed successfully, the project can be found on the HMI device. The transferred project is then started automatically.

See also

Operating modes (Page 166)
Data Transmission Options (Page 167)
Configuring the data channel (Page 145)
Overview (Page 168)

7.5.4 Starting backtransfer

Requirements

- No project is open on the configuring PC in WinCC flexible
- The HMI device is connected to this configuring PC
- The data channel is configured on the HMI device
- The HMI device is in "Transfer" mode
- The memory card containing the compressed project file is inserted into the HMI device

Procedure

Proceed as follows:

1. On the configuring PC, select the "Communication settings" command in the menu "Project > Transfer" in WinCC flexible.

The "Communication Settings" dialog opens.

2. Select the type of HMI device.
3. Select the type of connection between the HMI device and the configuring PC.
Set the connection parameters.

4. Close the dialog with "OK".

5. Select the "Transfer" > "Backtransfer" command in the "Project" menu.

The "Backtransfer" dialog opens.

6. Click "OK" to start the backtransfer process.

The configuring PC checks the connection to the HMI device. The compressed project file is transferred back from the HMI device to the configuring PC. If the connection is not available or is defective, an error message is displayed on the configuring PC.

Result

After successful backtransfer, the project is opened on the configuring PC in WinCC flexible.

7.5.5 Testing a project

Introduction

There are two options to test a project:

- Test the project on the configuring PC

You can test a project at a configuring PC, using a simulator. For detailed information, refer to the "WinCC flexible" user manual and to the WinCC flexible Online Help.

- Offline testing of the project on the HMI device

Offline testing means that communication between the HMI device and PLC is down while the test is being carried out.

- Online testing of the project on the HMI device

Online testing means that the HMI device and PLC communicate with each other during testing.

Perform the tests, starting with the "Offline test", followed by the "Online test".

Note

You should always test the project on the HMI device on which the project will be used.

Check the following:

1. Check the correct layout of the screens
2. Check the screen navigation
3. Check the input objects
4. Enter the tag values

The test increases the certainty that the project will run error-free on the HMI device.

Requirements for offline testing

- The project has been transferred to the HMI device
- The HMI device is in "Offline" mode

Procedure

In "Offline" mode, you can test individual project functions on the HMI device without them being affected by the PLC. PLC tags, therefore, are not updated.

Test the operating elements and visualization of the project as far as possible without connecting to the PLC.

Requirements for online testing

- The project has been transferred to the HMI device
- The HMI device is in "Online" mode

Procedure

In "Online" mode, you can test individual project functions on the HMI device without them being affected by the PLC. PLC tags are updated in this case.

You have the option to test all communication-dependent functions, for example alarms, etc.

Test the operating elements and views of the project.

See also

Operating modes (Page 166)

7.6 Backup and restore

7.6.1 Overview

Backup and restore

NOTICE
License keys License keys are not taken into account for backups and restores. License keys are saved in the working memory of the HMI device and cannot be deleted.

You can back up and restore the following data found in the internal flash memory of the HMI device with a PC:

- Project and HMI device image
- Password list
- Recipe data

Use one of the following tools for backup and restore:

- WinCC flexible
- ProSave

General information

NOTICE
Power failure If a complete restore operation is interrupted due to power failure on the HMI device, the operating system of the HMI device may be deleted! The operating system then has to be updated.
Compatibility conflict If a message is output on the HMI device warning of a compatibility conflict during the restore operation, the operating system must be updated.

7.6.2 Backup and restore using WinCC flexible

Requirements

- The HMI device is connected to a configuring PC
- No project is open in WinCC flexible
- The data channel is configured on the HMI device

Procedure for backup

Proceed as follows:

1. On the configuring PC, select the "Communication settings" command in the menu "Project > Transfer" in WinCC flexible.
The "Communication Settings" dialog opens.
2. Select the type of HMI device.
3. Select the type of connection between the HMI device and the configuring PC.
Set the connection parameters.
4. Close the dialog with "OK".
5. Select the "Backup" command in the menu "Project > Transfer" in WinCC flexible.
The "Backup Settings" dialog opens.
6. Select the data to be backed up.
7. Select a destination folder and a file name for the "*.psb" backup file.
8. Set "Transfer" mode on the HMI device.
If automatic transfer mode is enabled on the HMI device, the HMI device automatically sets "Transfer" mode when a backup is initiated.
9. Start the backup operation in WinCC flexible with "OK" on the configuring PC.
Follow the instructions in WinCC flexible.
A status view opens to indicate the progress of the operation.

Result

The system outputs a message when the backup is completed.
The relevant data is now backed up on the configuring PC.

Procedure for restore

Proceed as follows:

1. On the configuring PC, select the "Communication settings" command in the menu "Project > Transfer" in WinCC flexible.

The "Communication Settings" dialog opens.

2. Select the type of HMI device.
3. Select the type of connection between the HMI device and the configuring PC.
Set the connection parameters.

4. Close the dialog with "OK".

5. Select the "Restore" command in the menu "Project > Transfer" in WinCC flexible.

The "Restore Settings" dialog opens.

6. Select the "*.psb" backup file to be restored from the "Open" field.

You can see the HMI device for which the backup file was created and the type of backup data the file contains.

7. Set "Transfer" mode on the HMI device.

If automatic transfer mode is enabled on the HMI device, the device automatically sets "Transfer" mode when a restore operation is initiated.

8. Start the restore operation in WinCC flexible with "OK" on the configuring PC.

Follow the instructions in WinCC flexible.

A status view opens to indicate the progress of the operation.

Result

When the restore is successfully completed, the data backed up on the configuring PC is now on the HMI device.

See also

Operating modes (Page 166)

Data Transmission Options (Page 167)

Configuring the data channel (Page 145)

Overview (Page 174)

7.6.3 Backup and restore using ProSave

Requirements

- The HMI device is connected to a PC on which ProSave is installed
- The data channel is configured on the HMI device

Procedure for backup

Proceed as follows:

1. From the Windows Start menu, start ProSave on the PC.
2. Select the HMI device type in the "General" tab.
3. Select the type of connection between the HMI device and the PC.
Set the connection parameters.
4. Select the data to be backed up in the "Backup" tab.
5. Select a destination folder and a file name for the "*.psb" backup file.
6. Set "Transfer" mode on the HMI device.

If automatic transfer mode is enabled on the HMI device, the HMI device automatically sets "Transfer" mode when a backup is initiated.

7. Start the backup operation in ProSave with "Start Backup".

Follow the instructions in ProSave.

A status view opens to indicate the progress of the operation.

Result

The system outputs a message when the backup is completed.

The relevant data is now backed up on the PC.

Procedure for restore

Proceed as follows:

1. From the Windows Start menu, start ProSave on the PC.
2. Select the HMI device type in the "General" tab.
3. Select the type of connection between the HMI device and the PC.
Set the connection parameters.

4. Select the "*.psb" backup file to be restored from the "Restore" tab.

You can see the HMI device for which the backup file was created and the type of backup data the file contains.

5. Set "Transfer" mode on the HMI device.

If automatic transfer mode is enabled on the HMI device, the device automatically sets "Transfer" mode when a restore operation is initiated.

6. Start the restore operation in ProSave on the PC with "Start Restore".
Follow the instructions in ProSave.
A status view opens to indicate the progress of the operation.

Result

When the restore is successfully completed, the data backed up on the PC is now on the HMI device.

See also

- Operating modes (Page 166)
- Data Transmission Options (Page 167)
- Configuring the data channel (Page 145)
- Overview (Page 174)

7.7 Updating the operating system

7.7.1 Overview

Updating the operating system

A compatibility conflict may occur when transferring a project to the HMI device. This is caused by different versions of the configuration software used and the HMI device image available on the HMI device. If there are different versions, the transfer is aborted. A message indicating a compatibility conflict is displayed on the configuring PC.

There are two ways to match the versions:

- Update the HMI device image if the project was created with the most recent version of the configuration software
- Transfer a matching older version of the HMI device image if you do not want to adapt the project to the most recent version of the configuration software for the project

NOTICE
Data loss All data on the HMI device, such as the project, passwords and licenses, will be deleted when you update the operating system.
Data channels An operating system update resets all parameters for the data channels. The transfer can only be started in the Loader following reconfiguration of the data channels.

7.7.2 Reset to factory settings

ProSave or WinCC flexible support operating system updates with or without reset to factory settings.

- Updating the operating system without reset to factory settings
First, set "Transfer" mode on the HMI device or use the automatic transfer function if the project is active. Then start the operating system update in ProSave or WinCC flexible.
- Updating the operating system with reset to factory setting
First, start the operating system update in ProSave or WinCC flexible and switch the power on the HMI device off and on again when prompted.

Note

You have to perform an operating system update with reset to factory settings if the HMI device does not have an operating system yet or if the operating system of the HMI device has become corrupted. See chapter Connecting a Configuring PC (Page 74).

7.7.3 Updating the operating system using WinCC flexible

Requirements

- The HMI device is connected to a configuring PC
- No project is open in WinCC flexible
- Only when updating the operating system without reset to factory settings:
The data channel is configured on the HMI device.

Procedure

Proceed as follows:

1. Only when updating the operating system with reset to factory settings:
Switch off power to the HMI device.
2. On the configuring PC, select the "Communication settings" command in the menu "Project > Transfer" in WinCC flexible.
The "Communication Settings" dialog opens.
3. Select the type of HMI device.
4. Select the type of connection between the HMI device and the configuring PC, then set the connection parameters.
5. Close the dialog with "OK".
6. In WinCC flexible, select the command "Update OS" in the "Project > Transfer" menu.
7. You can specify operating system updates with or without reset to factory settings by activating/deactivating the "Reset to factory settings" check box.

8. In "Image path," select the HMI device image file "*.img."

The HMI device image files are available under "WinCC flexible Images" in the WinCC flexible installation folder or on the WinCC flexible installation CD.

Information on the version of the HMI device image file is displayed in the output area after you have successfully opened the file.

9. Only when updating the operating system without reset to factory settings:

Set "Transfer" mode on the HMI device.

If automatic transfer mode is enabled on the HMI device, the device automatically sets "Transfer" mode when an update is initiated.

10. In WinCC flexible, select "Update OS" on the configuring PC to run the operating system update.

11. Only when updating the operating system with reset to factory settings:

Switch on the power supply to the HMI device.

12. Follow the instructions in WinCC flexible.

During the operating system update a status view opens to indicate progress.

Result

A message is displayed when the operating system update is successfully completed.

The HMI device does no longer contain any project data.

7.7.4 Updating the operating system using ProSave

Requirements

- The HMI device is connected to a PC on which ProSave is installed.
- When updating the operating system without reset to factory settings:
The data channel is configured on the HMI device.

Procedure

Proceed as follows:

1. When updating the operating system with reset to factory settings:
Switch off power to the HMI device.
2. From the Windows Start menu, start ProSave on the PC.
3. Select the HMI device type in the "General" tab.
4. Select the type of connection between the HMI device and the PC, then set the connection parameters.
5. Select the "OS Update" tab.
6. You can specify operating system updates with or without reset to factory settings by activating/deactivating the "Reset to factory settings" check box.
7. In "Image path," select the HMI device image file "*.img."
The HMI device image files are available under "WinCC flexible Images" in the WinCC flexible installation folder or on the WinCC flexible installation CD.
Information on the version of the HMI device image file is displayed in the output area after you have successfully opened the file.
8. Only when updating the operating system without reset to factory settings:
Set "Transfer" mode on the HMI device.
If automatic transfer mode is enabled on the HMI device, the device automatically sets "Transfer" mode when an update is initiated.
9. Select "Update OS" on the PC to run the operating system update.
10. Only when updating the operating system with reset to factory settings:
Switch on the power supply to the HMI device.
11. Follow the instructions in ProSave.
During the operating system update a status view opens to indicate progress.

Result

A message is displayed when the operating system update is successfully completed.
The HMI device does no longer contain any project data.

7.8 Installing and removing options

7.8.1 Overview

Installing and removing options

You can install options on the HMI device, for example, additional programs developed especially for the HMI device.

You can also remove the option from the HMI device again.

Note

License key

A license key may be needed to run an option. The license key unlocks the option for use.

7.8.2 Installing and removing options using WinCC flexible

Requirements

- The HMI device is connected to a configuring PC
- No project is open in WinCC flexible
- The data channel is configured on the HMI device

Procedure for installing an option

Proceed as follows:

1. On the configuring PC, select the "Communication settings" command in the menu "Project > Transfer" in WinCC flexible.

The "Communication Settings" dialog opens.

2. Select the type of HMI device.
3. Select the type of connection between the HMI device and the configuring PC, then set the connection parameters.
4. Close the dialog with "OK".
5. Select the "Options" command in the menu "Project > Transfer" in WinCC flexible.
6. Select the desired option under "Available options".
7. Set "Transfer" mode on the HMI device.

If automatic transfer mode is enabled on the HMI device, the device automatically sets "Transfer" mode when the installation of an option is initiated.

8. Start the installation of the option in WinCC flexible on the configuring PC with the ">>" button.

Follow the instructions in WinCC flexible.

A status display appears indicating the progress of the installation.

Result

The option has now been installed on the HMI device.

Procedure for removing an option

Proceed as follows:

1. On the configuring PC, select the "Communication settings" command in the menu "Project > Transfer" in WinCC flexible.
The "Communication Settings" dialog opens.
2. Select the type of HMI device.
3. Select the type of connection between the HMI device and the configuring PC, then set the connection parameters.
4. Close the dialog with "OK".
5. Select the "Options" command in the menu "Project > Transfer" in WinCC flexible.
6. Select the desired option under "Installed options".
7. Set "Transfer" mode on the HMI device.
If automatic transfer mode is enabled on the HMI device, the device automatically sets "Transfer" mode when the removal of an option is initiated.
8. Start the removal of the option in WinCC flexible on the configuring PC with the "<<" button.
Follow the instructions in WinCC flexible.
A status display appears indicating the progress of the removal.

Result

The option has now been removed on the HMI device.

See also

- Operating modes (Page 166)
- Data Transmission Options (Page 167)
- Configuring the data channel (Page 145)
- Overview (Page 182)

7.8.3 Installing and removing options using ProSave

Requirements

- The HMI device is connected to a PC on which ProSave is installed
- The data channel is configured on the HMI device

Procedure for installing an option

Proceed as follows:

1. From the Windows Start menu, start ProSave on the PC.
2. Select the HMI device type in the "General" tab.
3. Select the type of connection between the HMI device and the PC.
4. Set the connection parameters.
5. Select the "Options" tab.
6. Select the desired option under "Available options".
7. Set "Transfer" mode on the HMI device.

If automatic transfer mode is enabled on the HMI device, the device automatically sets "Transfer" mode when the installation of an option is initiated.

8. Start the installation of the option in ProSave with the ">>" button.
9. Follow the instructions in ProSave.

A status display appears indicating the progress of the installation.

Result

The option has now been installed on the HMI device.

Procedure for removing an option

Proceed as follows:

1. From the Windows Start menu, start ProSave on the PC.
2. Select the HMI device type in the "General" tab.
3. Select the type of connection between the HMI device and the PC.
4. Set the connection parameters.
5. Select the "Options" tab.
6. Press the "Device status" button to update the display.
7. Select the desired option under "Installed options".
8. Set "Transfer" mode on the HMI device.

If automatic transfer mode is enabled on the HMI device, the device automatically sets "Transfer" mode when the removal of an option is initiated.

9. Start the removal of the option in ProSave with the "<<" button.

Follow the instructions in ProSave.

A status display appears indicating the progress of the removal.

Result

The option has now been removed on the HMI device.

See also

Operating modes (Page 166)
Data Transmission Options (Page 167)
Configuring the data channel (Page 145)
Overview (Page 182)

7.9 Transferring and transferring license keys

7.9.1 Overview

Transferring and transferring back license keys

With the purchase of an optional package, you obtain a specific user license with an associated license key. Once you have installed an option, transfer a license key to the HMI device. The license key unlocks an option for use.

You can also transfer back the license key from the HMI device to a license diskette.

Note

License keys can only be transferred and transferred back with the Automation License Manager or WinCC flexible.

7.9.2 Transferring and transferring back license keys

Requirements

- The HMI device is connected to a configuring PC
- When transferring or transferring back using WinCC flexible:
 - No project is open in WinCC flexible
- The data channel is configured on the HMI device
- The license diskette with the license key to be transferred must be inserted in the floppy drive of the configuring PC

Procedure for transferring a license key

Proceed as follows:

1. Switch to "Transfer" mode on the HMI device.
2. When transferring using WinCC flexible:
Select the "License Keys" command in the menu "Project > Transfer". The Automation License Manager opens.
When transferring using the Automation License Manager:
Start the Automation License Manager via the Windows Start menu.
3. In the Automation License Manager, select the command "Connect HMI device" in the menu "Edit > Connect target system".
The "Connect Target System" dialog opens.
4. Under "Device Type", select the appropriate HMI device type.
5. Select the type of connection in the "Connection" field and set the connection parameters.
6. Select "OK".
The connection to the HMI device is established. The connected HMI device is displayed in the left window of the Automation License Manager.
7. In the left window, select the source drive.
The right window displays the available license keys.
8. Drag one or more license keys from the right window and drop them on the HMI device in the left window.
The license keys are then transferred to the HMI device.

Result

The license key has now been transferred from the license diskette to the HMI device.

Procedure for transferring a license key back

Proceed as follows:

1. Switch to "Transfer" mode on the HMI device.
2. When transferring back using WinCC flexible:
 - Select the "License Keys" command in the menu "Project > Transfer". The Automation License Manager opens.
 - When transferring back using the Automation License Manager:
 - Start the Automation License Manager via the Windows Start menu.
3. In the Automation License Manager, select the command "Connect HMI device" in the menu "Edit > Connect target system".
 - The "Connect Target System" dialog opens.
4. Under "Device Type", select the appropriate HMI device type.
5. Select the type of connection in the "Connection" field and set the connection parameters.
6. Select "OK".
 - The connection to the HMI device is established. The connected HMI device is displayed in the left window of the Automation License Manager.
7. In the left window, select the HMI device.
 - The right window displays the available license keys.
8. Drag one or more license keys from the right window and drop them on the HMI device in the left window.
 - The license keys are then transferred back to the license diskette.

Result

The license key has now been transferred back from the HMI device to the license diskette.

See also

- Operating modes (Page 166)
- Data Transmission Options (Page 167)
- Configuring the data channel (Page 145)
- Overview (Page 185)

Operating a project

8.1 Overview

Configuration and process control phase

HMI devices can be used to operate and monitor tasks in process and production automation. The plant screens on the HMI devices are used to provide a clear overview of the active processes.

The HMI device project, which includes the plant screens, is created during the configuration phase. The configuration engineer defines which tasks the HMI device has in the process and defines the following in detail:

- Which process data is displayed on the individual HMI device
- Which plant components are controlled by this HMI device

The configuration engineer stores this information in the project's screens. The project is transferred to the HMI device during commissioning.

After transfer to the HMI device, current processes can be operated and monitored in the project's screens. The screens enable you to observe, for example, operational states, current process data and faults in a plant. Operator controls which are used to operate the process, for example buttons, I/O fields and alarm windows, are displayed in the screens.

Operator control options

- Touch screen

The HMI device is operated by means of the touch screen. The operator controls shown in the dialogs are touch-sensitive. Touch objects are basically operated in the same way as mechanical keys. You activate operator controls by touching them with your finger. To double-click them, touch an operator control twice in succession.

 CAUTION
--

Do not use any pointed or sharp objects when operating the touch screen. Otherwise this may damage the plastic membrane of the touch screen.
--

- External operator controls

The following operator controls can be connected externally.

- External keyboard, connected via USB
- External mouse, connected via USB

The usage of external control elements is recommended for commissioning.

Operating a project with an external keyboard

An external keyboard can be used to operate a project in exactly the same way as with the HMI keyboard or screen keyboard.

Note

The function keys of the external keyboard are disabled.

Use other keys on the external keyboard, which correspond to the HMI device keys.

Operating a project with an external mouse

An external mouse can be used to operate a project in exactly the same way as with the HMI touch screen. Click the described operator controls with the mouse.

Unintentional actions

 CAUTION
Do not carry out several operations simultaneously. You may otherwise trigger unintentional actions.
<ul style="list-style-type: none">• With touch control: Always touch only one operator control on the screen• With key operation via an external keyboard: Do not press more than two keys simultaneously

Observing the plant documentation

Some operations with the project may require in-depth knowledge about the specific plant on the part of the operator. Proceed with caution, for example, when you use jog mode. Further information on this may be available in your plant documentation.

Operation feedback from operator controls

The HMI device provides optical feedback as soon as it detects that an operator control has been selected. The operator control receives the focus and is selected. This selection is independent of any communication with the PLC. Therefore this selection does not indicate whether the relevant action is actually executed or not.

The configuration engineer can also configure the selection of an operator control so that it deviates from the standard. Further information on this may be available in your plant documentation.

Optical feedback from operator controls

The type of optical feedback depends on the operator control:

- Buttons

The HMI device outputs different views of the "Pressed" and "Unpressed" states, provided the configuration engineer has configured a 3D effect:

- "Pressed" state:



- "Unpressed" state:



The configuration engineer determines the appearance of a marked field, for example, line width and color for the focus.

- Invisible buttons

By default, invisible buttons are not displayed as pressed when they are touched. No optical operation feedback is provided in this case.

The configuration engineer may, however, configure invisible buttons so that their outline appears as lines when touched. This outline remains visible until you select another operator control.

- I/O fields

When you select an I/O field, the content of the I/O field is displayed against a colored background. With touch operation, a screen keyboard is displayed for the entering of values.

8.2 Direct keys

Introduction

Direct keys on the HMI device are used to set bits in the I/O area of a SIMATIC S7.

Direct keys enable operations with short reaction times, that are, for example, a jog mode requirement.

NOTICE

Removing the connecting cable

Note that when removing the connecting cable, this corresponds to a failure of a PROFIBUS DP slave or PROFINET IO device and therefore causes a PLC stop.

Determine suitable program-technical measures in the PLC, in order to prevent a PLC stop.

Further information on this may be available in your plant documentation.

NOTICE

Direct keys are still active when the HMI device is in "offline" mode.
--

NOTICE

If you operate a function key with direct key functionality in a running project, the direct key function is always executed, independent of the current screen contents.

Direct keys

The following objects can be configured as a direct key:

- Buttons
- Function keys
- Screen numbers
- Handwheel
- Illuminated pushbutton
- Key-operated switch

Note

Direct keys

You can only use direct keys when coupled to PROFIBUS DP or PROFINET IO. Direct keys result in additional basic load on the HMI device.

Further information about direct keys is available in the system manual "WinCC flexible communication".

See also

Enabling PROFINET IO (Page 148)

8.3 Setting the project language

Introduction

The HMI device supports multilingual projects. You must have configured a corresponding operating element which lets you change the language setting on the HMI device during runtime.

The project always starts with the language set in the previous session.

Requirements

- The required language for the project must be available on the HMI device
- The language switching function must be logically linked to a configured operating element such as a button

Selecting a language

You can change project languages at any time. Language-specific objects are immediately output to the screen in the new language when you switch languages.

The following options are available for switching the language:

- A configured operating element switches from one language to the next in a list
- A configured operating element directly sets the desired language

Please refer to your system documentation to check whether additional information on this subject is available there.

See also

Changing Regional Settings (Page 131)

8.4 Entering values using the touch screen

8.4.1 Overview

Screen keyboard

When you touch an operating element requiring entry on the HMI device touch screen, a screen keyboard appears. The screen keyboard is displayed in the following cases:

- An I/O field is selected for input
- A password must be entered for accessing a password-protected function

The screen keyboard is automatically hidden again when input is complete.

Based on the configuration of the operating element, the system displays different screen keyboards for entering numerical or alphanumerical values.

Note

The screen keyboard display is independent of the configured project language.

General procedure

The operating elements of a screen are operated by touching the touch screen.

Proceed as follows:

1. Touch the desired operating element within the screen.
2. Depending on the operating element, perform further actions. Detailed descriptions can be found under the respective operating element.

Examples:

- I/O field: Enter numerical, alphanumerical or symbolic values in the I/O field
- Symbolic I/O field: Select an entry from the drop down list box
- Slider control: Move the slider control

Procedure for text boxes

Values are entered in the project text boxes. Based on your configuration, the values are saved to tags and transferred, for example, to the PLC.



Proceed as follows:

1. Touch the desired text box within the screen.

The screen keyboard opens.

Depending on your configuration, you can enter values in the text box in the following manner:

- Numerical values, for example decimal numbers, hexadecimal numbers, binary values
- Alphanumerical values, for example digits and letters
- Date/time

2. Enter the value.
3. Confirm your entry with  or discard your entry with the button .

8.4.2 Entering and editing numerical values

Numerical screen keyboard

When you touch an operating element for numerical input on the HMI-device touch screen, the numerical screen keyboard appears. This is the case, for example, for a text box. The screen keyboard is automatically hidden again when input is complete.



Numerical screen keyboard

Note

Opened screen keyboard

When the screen keyboard is open, PLC job 51, "Select screen" has no function.

Formats for numerical values

You can enter values in numerical text boxes based on the following formats:

- Decimal
- Binary
- Hexadecimal

Note

Entry of hexadecimal values

When you enter values in hexadecimal format, the alphanumeric screen keyboard opens.

Limit value test of numerical values

Tags can be assigned limit values. If you enter a value that lies outside of this limit, it will not be accepted, for example, 80 with a limit value of 78. In this case the HMI device will deliver a system alarm, if an alarm window is configured. The original value is displayed again.

Decimal places for numerical values

The configuration engineer can define the number of decimal places for a numerical text box. The number of decimal places is checked when you enter a value in this type of I/O field.

- Decimal places in excess of the limit are ignored
- Empty decimal places are filled with "0"

Procedure

Numerical values can be entered character-by-character via the buttons on the numerical screen keyboard.

Proceed as follows:

1. Touch the desired operating element within the screen.



The numerical screen keyboard opens. The existing value is displayed in the screen keyboard and is selected.

2. Enter the value.

When entering hexadecimal values, the keys with letters "G" to "Z" are operable, but the characters will not be entered.

You have the following options to enter a value:

- The selected value is deleted when you enter the first character. Completely reenter the value.



- Use the  and  keys to move the cursor within the current value. You can now edit the characters of the current value or add characters.

Use the  key to delete the character to the left of the cursor. If the value is selected, use this key to delete the selected part of the value.

The  key deletes the character positioned to the right of the cursor. If the value is selected, use this key to delete the selected part of the value.

- Use the  key to display the infotext of the I/O field.

This key is only enabled if infotext has been configured for the input object or the current screen.

3. Use the  key to confirm your entry or cancel it with . Either action closes the screen keyboard.

Result

You have changed the numerical value or entered a new one.

8.4.3 Entering and editing alphanumerical values

Alphanumerical screen keyboard

When you touch an operating element for numerical input on the HMI-device touch screen, the alphanumerical screen keyboard appears. This is the case, for example, for a text box. The screen keyboard is automatically hidden again when input is complete.



Alphanumerical screen keyboard, normal level

Note

Opened screen keyboard

When the screen keyboard is open, PLC job 51, "Select screen" has no function.

Language change

Language change in the project has no influence on the alphanumerical screen keyboard. The entry of Cyrillic or Asian characters is therefore not possible.

Keyboard levels

The alphanumerical screen keyboard has various levels.

- Normal level
- Shift level

If you change the levels with key , the key assignments change.

Procedure

Alphanumerical values can be entered character-by-character via the buttons on the alphanumerical screen keyboard.

Proceed as follows:



1. Touch the desired operating element within the screen.

The alphanumerical screen keyboard opens. The existing value is displayed in the screen keyboard and is selected.

2. Enter the value.

You have the following options to enter a value:

- The selected value is deleted when you enter the first character. Completely reenter the value.

- Use the  and  keys to move the cursor within the current value. You can now edit the characters of the current value or add characters.



Use the  key to delete the character to the left of the cursor. If the value is selected, use this key to delete the selected part of the value.

The  key deletes the character positioned to the right of the cursor. If the value is selected, use this key to delete the selected part of the value.

- Using key  it is possible to switch between the keyboard levels of the screen keyboard. On switchover, the key assignments of the screen keyboard change.

- Use the  key to display the infotext of the I/O field.

This button is only enabled if infotext has been configured for the input object or the current screen.

- 3. Use the  key to confirm your entry or cancel it with . Either action closes the screen keyboard.

Result

You have changed the alphanumeric value or entered a new one.

8.4.4 Entering the date and time

Entering the date and time

Enter the date and time in the same way you enter alphanumeric values.

Note

When entering the date and time, please note that the format is determined by the configured project language.

See also

Entering and editing alphanumeric values (Page 197)

Setting the project language (Page 193)

8.4.5 Entering symbolic values

Drop down list box

Operating elements for entering symbolic values offer you a list from which you can select the input values. When you touch a symbolic I/O field on the HMI device touch screen, the following drop down list box opens.

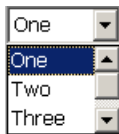



Symbolic I/O field after touch, example

Procedure

Proceed as follows:

1. Touch the required operating element.

The drop down list box of the operating element opens. Select  and  to scroll in the drop down list box.

2. Touch the required entry in the drop down list box.

The selected entry is accepted as an entry.

Result

You have changed the symbolic value or entered a new one.

8.4.6 Displaying infotext

Purpose

The configuration engineer uses infotext to provide additional information and operating instructions. The configuration engineer can configure infotext on screens and operating elements.

The infotext of an I/O field may contain, for example, information on the value to be entered.

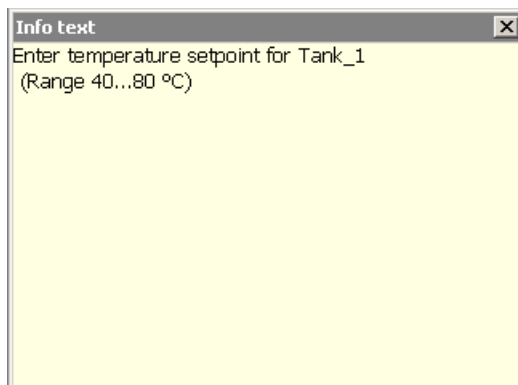

Infotext for an I/O field, example

Opening infotext for operating elements

1. Touch the required operating element.

The screen keyboard opens. You can see from the appearance of the  key whether infotext has been configured for the operating element or the current screen.

2. Touch the  key on the screen keyboard.

The infotext for the operating element is displayed. If there is no infotext for the selected screen object, the infotext for the current screen is displayed, if it has been configured.

You can scroll through the contents of long infotext with  and .

Note

Switching between displayed infotext

The configuration engineer can configure infotext for an I/O field and the associated screen. You can switch between two infotexts by touching the infotext window.

3. Close the displayed infotext by pressing .

Alternative procedure

Depending on your configuration, infotext can also be called via a configured operating element.

Please refer to your system documentation to check whether additional information on this subject is available there.

8.5 Function keys

Function keys

Function key assignment is defined during configuration. The configuration engineer can assign function keys globally and locally.

Function keys with global function assignment

A globally assigned function key always triggers the same action on the HMI device or in the PLC irrespective of the screen displayed. Such an action could be, for example, the activation of a screen or the closure of an alarm window.

Function keys with local function assignment

A function key with local function assignment is screen-specific and is therefore only effective within the active screen.

The function assigned locally to a function key can vary from screen to screen.

The function key of a screen can be assigned one function only, either a global or local one. The local assignment function takes priority over the global setting.

The configuration engineer can assign function keys in such a way that you can operate operating elements with function keys, for example, the alarm view, trend view, recipe view or status / PLC.

Multi-key operation

Unwanted actions may be triggered, if the operator unintentionally actuates a key combination.

CAUTION

Unintentional actions

In "Online" mode, simultaneous operation of more than two keys may cause unintentional actions in the plant.

Do not press more than two keys simultaneously.

8.6 Bar and gauge

Bar

The bar is a dynamic display object. The bar displays a value from the PLC as a rectangular area. The bar allows you to recognize the following at a glance:

- The distance of the current value from the configured limit values
- Whether a set point value has been reached

The bar can display values such as fill levels or batch counts.

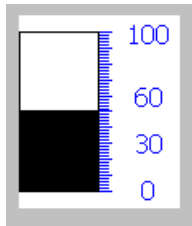

Layout

The layout of the bar depends on the configuration:

- The bar may feature a scale of values
- The configured limit values can be indicated by lines
- Color changes can signal when a limit value has been exceeded or has not been reached

Gauge

The gauge is a dynamic display object. The gauge displays numerical values in analog form by means of a pointer. This enables an operator at the HMI device to see at a glance if the boiler pressure is in the normal range, for example.

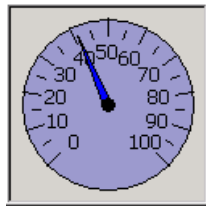

Layout

The layout of the gauge depends on the configuration:

- A trailing pointer can display the maximum value reached so far on the scale. The trailing pointer is reset when the screen is reloaded
- The label on the scale can show the measured variable, for example boiler pressure and the physical unit, for example bar

Operation

The bar and the gauge are for display only. Both objects cannot be controlled by the operator.

8.7 Operating the switch

Introduction

The switch is an operating element and display object with two predefined switching states, for example "On" and "Off". Switches can signalize the state of a plant section, for example if a motor is running or not. At the same time, you can use the switch to change the state of the corresponding plant section via the HMI device, for example from "On" to "Off".

Layout

The layout of the switch depends on the configuration:

- Switch with slider

The two states are displayed by the position of the slider

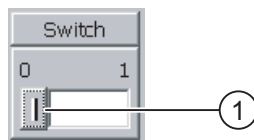

① Slider

- Switch with text or graphic

The two states are displayed by the label on the slider

Depending on the switching state, the switch is labeled with one of two texts or one of two graphics.

Examples:

"Backward" or "Forward"

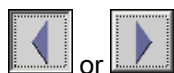

Procedure

- Switch with slider

Proceed as follows:

Move the slider to the other position or double-click the slider area

- Switch with text or graphic

Proceed as follows:

Touch the switch

Result

The switch changes its appearance. The associated value is switched.

8.8 Operating the slider control

Introduction

The slider control can be used to monitor and change process values within a defined range. The slider control can also be configured without a slider. In this case, you cannot enter a value. The slider control is then only used for displaying values.

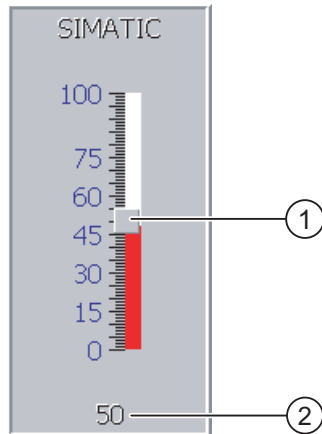

- ① Slider control for entering values
- ② Value display with current value

Slider control – example

Layout

The layout of the slider control depends on the configuration:

- The slider control can contain a label and a setting range
- The current value can be displayed below the area of the slider control

Procedure

Proceed as follows:

1. Touch the slider of the desired slider control.
2. Move the slider to the required value.
If a value display has been configured, you can check the exact value that has been set.
3. Release the slider.

Result

The set value is applied.

8.9 Operating the trend view

Trends

Trends continuously display the current process data or process data from a log.

Trend view

Trends are displayed in the trend view. A trend view can display several trends simultaneously.

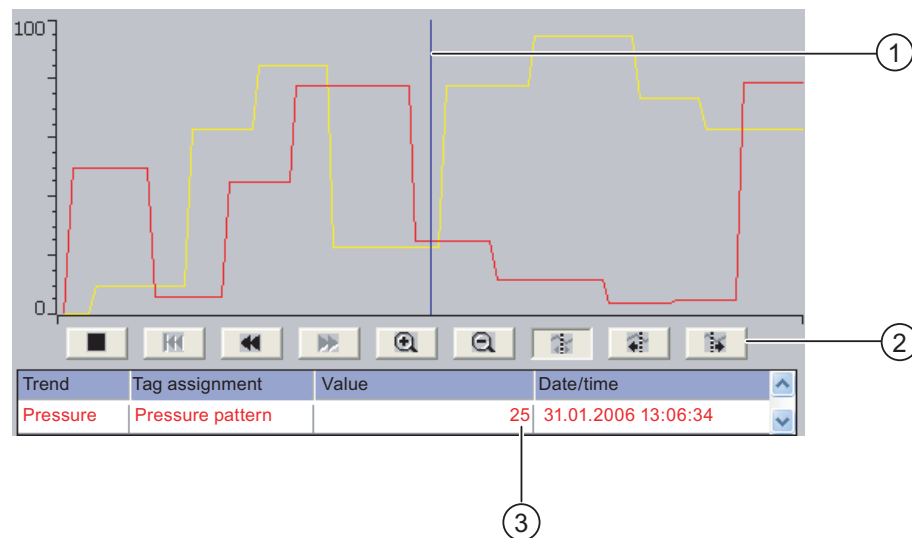

- ① Ruler
- ② Buttons for trend operation
- ③ Trend value in the value table

Trend view, example

Layout and operation

The layout and operation of the trend view depends on the configuration. The configuration engineer determines, for example, the following:

- Appearance of the trend view, the axes, value ranges and labels
- Operating options of the trend view
- Limit values for the trend values
- The change of color of the trend in the event of limit violation

Please refer to your system documentation to check whether additional information on this subject is available there.

Value table

The trend values can be read from the value table if this is configured:

- When the ruler is displayed, the trend values are shown at a position of the ruler in the value table
- When the ruler is hidden, the latest trend values are displayed in the value table

Ruler

When configured, a ruler is available to provide an exact reading of the trend values in the value table.









You can move the ruler to the desired position of the trend view.

Operation

The trend view can be operated as follows:

- Enlarge or reduce the display of time intervals
- Scroll forward or back by one display width
- Stop and resume trend recording
- Move the ruler
- Hide and display the ruler

The following table shows the trend view buttons:

Buttons	Functions
	Stops or continues trend recording
	Zooms the displayed time section
	Zooms out of the displayed time section
	Scrolls one display width backwards (to the left)
	Scrolls one display width forwards (to the right)
	Scrolls back to the beginning of the trend recording. The start values of the trend recording are displayed there.
	Moves the ruler backwards (to the left)
	Moves the ruler forwards (to the right)
	Inserts or removes the ruler

In addition, the configuration engineer can configure function keys or operating elements with which you can control trend views.

Please refer to your system documentation to check whether additional information on this subject is available there.

Operation

Touch the required button in the trend view.

The position of the ruler can also be changed by means of touching and dragging the ruler on the touch screen.

8.10 Operating the status force

8.10.1 Overview

Application

You read or write access values of the connected PLC directly with status force. Status force allows you to monitor or change addresses of the PLC program, etc. You don't need to connect an additional programming device or additional PC to the PLC.

Note

Status force can only be used in combination with SIMATIC S5 or SIMATIC S7.

Layout

The layout of status force depends on the configuration.

The figure shows the general layout of status force. A value can be monitored or controlled on every line.

Connection	Type	Offset	Format	Control Value
PLC_1	M	120	DEC	33
PLC_1	T	40	T	24,00
PLC_1	O	50	DEC	0
PLC_1	O	50	HEX	0A0D

Status force, example

The configuration engineer specifies which columns appear in status force.



The table shows the significance of all configurable columns.

Column	Functions
"Connection"	The PLC whose address ranges must be displayed.
"Type", "DB Number", "Offset", "Bit"	The address range of the value
"Data Type", "Format"	The data type of the value
"Status Value"	The value read from the specified address.
"Control Value"	The value to be written to the specified address.

Further information on this may be available in your plant documentation

Operating elements

Depending on your configuration, you can operate the trend view using the following buttons:

Buttons	Functions
	"Read" button Updates the display in the "Status Value" column. This button engages when it is pressed. You cannot operate any text boxes until the button is actuated again and the refresh is stopped.
	"Write" button Applies the new value in the "Control Value" column. The control value is written to the PLC.

8.10.2 Operation

Operator input options

Status Force can be operated as follows:

- Change the column sequence
- Read the status values of the connected PLC
- Enter values and transfer them to the PLC

Change column sequence

Depending on the configuration, you can change the column sequence of Status Force.

Proceed as follows:

1. Touch the column header which you wish to exchange with a different column header
2. Keeping the touch screen pressed, move the column heading to the column heading you wish to exchange it with

Result

The columns are displayed in the modified sequence.

Procedure for reading the status value

Proceed as follows:

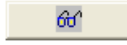
1. Enter the address and the desired format of a value for each line. Touch the respective columns to display the screen keyboard.
2. Once you have entered all of the desired values, touch the  button.

Result

All values are read cyclically by the PLC and entered in the "Status value" column until the  button is touched again.

Requirements for forcing

The following requirements must be fulfilled in order to force values:

- The "Control value" column must be available
- The "Write" button must be available

Procedure for forcing a value

Proceed as follows:

1. Enter the address of a value for each line. Enter the desired value in the "Control value" column. Touch the respective columns to display the screen keyboard.
2. Once you have entered all of the desired values, touch the  button.

Result

The values from the "Control value" column are transferred once to the PLC.

8.11 Operating the Sm@rtClient view

8.11.1 Overview

Application

The Sm@rtClient view enables you to monitor and remotely operate the current project of a remote HMI device. With the correct configuration, several equal priority HMI devices can access a remote HMI device.

Note

If another HMI device accesses your HMI device via the Sm@rtClient view, this leads to an additional load on your HMI device.

Layout

In the Sm@rtClient view, the remote HMI is displayed with the complete layout.

Depending on the configuration, you can monitor and also operate this screen.

You can also operate the function keys like buttons on an HMI device with a touch screen.

Monitoring mode

On a Sm@rtClient view which is configured for monitoring mode, you can only monitor the remote HMI device. You cannot control its operation.

Operation

Note

It is not possible to operate the direct keys of the remote HMI device from the local HMI device.

The available operator controls depend on the HMI devices used:

- Same type of HMI devices

You can operate the project of the remote HMI device with the operator controls of your HMI device

- Operate keys from the local touch screen

All the keys of the remote HMI device are displayed as buttons on the touch screen. You can also touch them to operate them

8.11.2 Operation

Operator input options

The Sm@rtClient view can be operated as follows:

- Starting remote control
- Forcing permission
- Ending remote control

Procedure for starting remote control

Proceed as follows:

1. On the HMI device change to the screen with the Sm@rtClient view.

The following options are available for establishing the connection to the remote HMI device:

- The connection is established automatically.
- The connection must be established by touching the appropriate button.

Depending on the configuration, you may be required to enter the address of the remote HMI device and a password.

2. The current screen of the project running on the remote device is displayed on the screen of your HMI device.
3. You can now monitor or control this screen depending on your configuration.

Scroll bars are displayed if the screen of the remote HMI device is larger than that of the current HMI device.

Procedure for forcing permission

If several HMI devices have access to a HMI device, only one HMI device has operating permission at any one time.

Two cases must be distinguished for this case:

- If another HMI device is already controlling the remote HMI device, if configured accordingly, you can force operating permission for the remote HMI device
 - You are trying to operate the remote HMI device
 - A dialog appears in which you are prompted to enter the appropriate password for forcing remote control
 - You are now authorized to operate the remote HMI device
- If another HMI device is accessing your HMI device via the Sm@rtClient view, you can force local operating permission for your HMI device
 - Touch the screen of your HMI device five times consecutively
 - You are given permission to operate your local HMI device

Procedure for ending remote control

You can end monitoring and control of a remote HMI device with one of the following methods depending on the configuration:

- Touch a button configured for this action
- Exit the screen containing the Sm@rtClient view
- If configured, a menu is displayed after you have touched an empty space over a longer period. Select the "Close" menu item.

Please refer to your system documentation to check whether additional information on this subject is available there.

8.12 Project security

8.12.1 Overview

Design of the security system

The configuration engineer can protect the operation of a project by implementing a security system.

The security system is based on authorizations, user groups and users.

If operating elements protected by a password are operated, the HMI device first requests that you log on. A logon screen is displayed in which you enter your user name and password. After logging on, you can operate the operating elements for which you have the necessary authorizations.

The logon dialog can be set up by the configuration engineer via an individual operating element.

In the same way, the configuration engineer can set up an operating element to log off. After logging off, objects assigned password protection can no longer be operated; to do so, log on again.

Further information on this may be available in your plant documentation

User groups and authorizations

Project-specific user groups are created by the configuration engineer. The "Administrators" and "PLC User" groups are included in all projects by default. User groups are assigned authorizations. Authorization required for an operation is specifically defined for each individual object and function in the project.

Users and passwords

Each user is assigned to exactly one user group.

The following people are allowed to create users and assign them passwords:

- The configuration engineer during configuration
- The administrator on the HMI device
- A user with user management authorization on the HMI device

Irrespective of the user group, each user is allowed to change his own password.

Logoff times

A logoff time is specified in the system for each user. If the time between any two user actions, such as entering a value or changing screens, exceeds this logoff time, the user is automatically logged off. The user must then log on again to continue to operate objects assigned password protection.

Backup and restore

The user data is encrypted and saved on the HMI device to protect it from loss due to power failure.

The users, passwords, group assignments and logoff times set up on the HMI device can be backed up and restored. This prevents you having to enter all of the data again on another HMI device.

NOTICE

The currently valid user data is overwritten in the following cases:

- Depending on the transfer settings, when the project is transferred again
- Upon restore of a backed-up project
- Upon import of the user administration via an operating element. Further information on this may be available in your plant documentation

The retransferred or restored user data and passwords are valid with immediate effect.

Limits for user, password and user View

	Number of characters
Length of user name, maximum	40
Length of password, minimum	3
Length of password, maximum	24
Entries in user view, maximum	50

8.12.2 User view

Application

The user view is used to display the users on the HMI device:

- All users on the HMI device are displayed in the user view to the administrator or to a user with administrator authorizations
- If you are a user without user management authorization, you can only see your personal user entry

The authorizations of a user after logging on depends on the user group to which the user is assigned.

Please refer to your system documentation to check whether additional information on this subject is available there.

Layout

The configuration engineer can implement a simple or extended user view.
The two user views offer the same functions. They differ only in the display of information.

Simple user view

If you are not logged on to the HMI device, the only entry contained in the simple user view is "<ENTER>".

If you are logged on to the HMI device, the simple user view only displays the user name and user group.



Admin	Group (9)
PLC User	Group (1)
User 1	Group (1)
<New user>	

Extended user view

The extended user view displays information about the users.

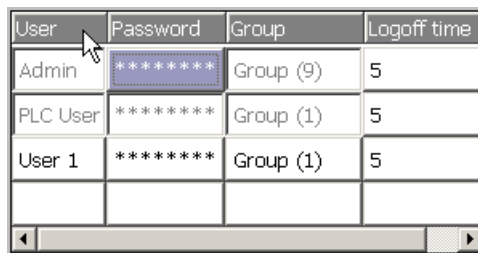

User	Password	Group	Logoff time
Admin	*****	Group (9)	5
PLC User	*****	Group (1)	5
User 1	*****	Group (1)	5

The extended user view contains the following columns:

- Users
- Password
- Group
- Logoff time

The passwords are encrypted by appearing as asterisks.

8.12.3 User logon

Logon dialog

Use the logon dialog to log on to the security system of the HMI device. Enter your user name and password in the logon dialog.

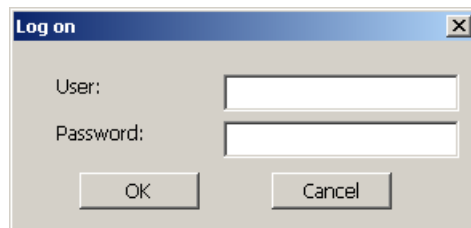

The logon dialog opens in the following cases:

- You are operating an operator control with password protection.
- You are operating an operator control that was configured for displaying the logon dialog.
- Activate the "<ENTER>" entry in the simple user view.
- Activate a blank entry in the extended user view.
- The logon dialog will be automatically displayed when the project is started, depending on the configuration.

Further information on this may be available in your plant documentation.

Requirements

The logon dialog is open.

Procedure

Proceed as follows:

1. Enter the user name and password.
Touch the corresponding input field. The alphanumerical screen keyboard is displayed.
2. Select "OK" to confirm logon.

Note

The user name is not case-sensitive.

The password is case-sensitive.

Result

After successful logon to the security system, you can execute password-protected functions on the HMI device for which you have authorizations.

If you enter a wrong password, an error message is displayed when an alarm window has been configured.

8.12.4 User logoff

Requirements

You have logged into the security system of the HMI device.

Procedure

You have the following options for logging off:

- You press an operating element that was configured for logoff
- You will be logged off automatically if you are not operating the project and if the logoff time has been exceeded

You will also be automatically logged off if you enter an incorrect password.

Result

You are no longer logged into the project. In order to activate an operating element with password protection, you must first log on again.

8.12.5 Creating users

Requirements

You have opened a screen containing the user view.

You have user management authorization or you are the administrator.

NOTICE
The following characters cannot be used in passwords: <ul style="list-style-type: none">• Blank• Special characters * ? . % / \ ' "

Procedure for creating a user in the simple user view

Proceed as follows:

1. Touch the "<New User>" entry in the user view.

The following dialog opens:

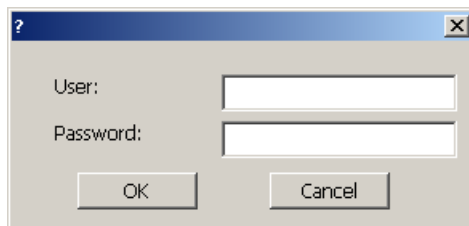

2. Enter the desired user name and password.



Touch the corresponding text box. The alphanumerical screen keyboard is displayed.

3. Touch the "OK" button.

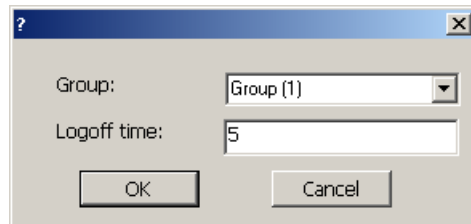
The following dialog opens:



4. Assign the user to a group.

In order to do so, open the "Groups" drop down list by means of the  button. Select  and  to scroll in the drop down list box.

5. Touch the required entry in the drop down list box.

The selected entry is then accepted as input.

6. Touch the text box "Logoff time". The screen keyboard is displayed.

7. Enter a value between 0 and 60 for the logoff time in minutes. The value 0 stands for "no automatic logoff."

8. Touch the "OK" button to confirm your entries.

Procedure for creating a user in the enhanced user view

Proceed as follows:

1. Touch the desired field in the blank line of the user view.

The appropriate screen keyboard is displayed.

2. Switch into input mode by means of the  key.

3. Enter the respective user data in the field:

- Assign the user to one of the groups from the drop down list box.
- Enter a value between 0 and 60 for the logoff time in minutes. The value 0 stands for "no automatic logoff."

Result

The new user is created.

8.12.6 Changing user data

Requirements

You have opened a screen containing the user view.

Which data you are allowed to change depends on your authorization:

- You are an administrator or a user with user management authorization. In these cases you are allowed to change the data for all the users on the HMI device in the user view:
 - User name
 - Group assignment
 - Password
 - Logoff time
- You are a user without user management authorization. In this case you are only allowed to change your personal user data:
 - Password
 - Logoff time, if configured

Note

You can only change the logoff time and password for the "Admin" user.

You can only change the logoff time for the "PLC_User". This user is used for logging on via the PLC

Procedure for changing user data in the simple user view

Proceed as follows:

1. In the user view, touch the user whose user data you want to change
2. When entering the data, use exactly the same procedure as for creating a user

Procedure for changing user data in the extended user view

Proceed as follows:

1. In the user view, touch the user whose user data you want to change
2. When entering the data, use exactly the same procedure as for creating a user

Result

The user data for the user is changed.

8.12.7 Deleting users

Requirements

You have opened a screen containing the user view.

To delete a user, you must be an administrator or have user management authorization.

Note

The "Admin" and "PLC_User" users exist by default. These users cannot be deleted.

Procedure

To delete a user, delete the user name entered.

Result

The user has been deleted and may no longer log onto the project.

8.13 Closing the project

Procedure

Proceed as follows:

1. Use the corresponding operator control object to close the project.
Wait for the loader to open after you closed the project.
2. Switch off power to the HMI device.

Note

Recovery time

Wait for approximately one second after you have removed the connecting cable from the connection box before you plug the connecting cable back into the connection box.

Operating alarms

9.1 Overview

Alarms

Alarms indicate events and states on the HMI device which have occurred in the system, in the process or on the HMI device itself. A status is reported when it is received.

An alarm could trigger one of the following alarm events:

- Incoming
- Outgoing
- Acknowledge

The configuration engineer defines which alarms must be acknowledged by the user.

An alarm may contain the following information:

- Date
- Time
- Alarm text
- Location of fault
- State
- Alarm class
- Alarm number
- Alarm group
- Diagnostics capability

Alarm classes

Alarms are assigned to various alarm classes:

- Error
Alarms in this class must always be acknowledged. Error alarms normally indicate critical errors within the plant such as "Motor temperature too high"
- Operation
Warning alarms usually indicate states of a plant such as "Motor switched on"
- System
System alarms indicate states or events which occur on the HMI device

- SIMATIC diagnostic alarms

SIMATIC diagnostic alarms show states and events of the SIMATIC S7 or SIMOTION PLCs

- User-specific alarm classes

The properties of this alarm class must be defined in the configuration

Please refer to your system documentation to check whether additional information on this subject is available there.

Alarm groups

The configuration engineer can group alarms into alarm groups. When you acknowledge an individual alarm of an alarm group, you acknowledge all alarms which belong to the same alarm group.

Alarm buffer

The alarm events are stored in an internal buffer. The size of this alarm buffer depends on the HMI device type.

Alarm report

The configuration engineer can activate alarm reporting on the project. In this case, alarm events are output directly on the connected printer.

The configuration engineer can define whether each individual alarm is logged. An alarm of this type is printed when the alarm events "Incoming" and "Outgoing" occur.

If you want to print alarms of the "System" alarm class, you have to print the contents of the associated alarm buffer. For this case the configuration engineer has to configure an operating element for printing the alarm buffer.

Alarm log

Alarm events are stored in an alarm log, provided this log file is configured. The capacity of the log file is limited by the storage medium and system limits.

9.2 Recognizing pending alarms

You can recognize pending alarms that must be acknowledged by means of the alarm indicator.

The alarm indicator is a graphic symbol indicating pending alarms or alarms requiring acknowledgment, depending on the configuration. The configuration determines whether an alarm has to be acknowledged or not. This is also defined by the alarm class which an alarm belongs to.



Alarm indicator with three pending alarms

The alarm indicator flashes as long as alarms are pending for acknowledgment. The number displayed indicates the number of pending alarms. The configuration engineer can assign functions to be executed when the alarm indicator is operated.

Usually, the alarm indicator is only used for error alarms. Please refer to your system documentation to check whether additional information on this subject is available there.

9.3 Displaying alarms

Displaying alarms

Alarms are displayed in the alarm view or in the alarm window on the HMI device.

Alarm view

Depending on the configuration, the alarm view is displayed as follows:

- As a single line. Alarm numbers and alarm texts are displayed as single lines
- As simple alarm view
- As extended alarm view

In the simple or extended alarm views the configuration engineer specifies the alarm information to be displayed.

Depending on the configuration, alarms from alarm logs are also displayed in the alarm view.

Simple alarm view

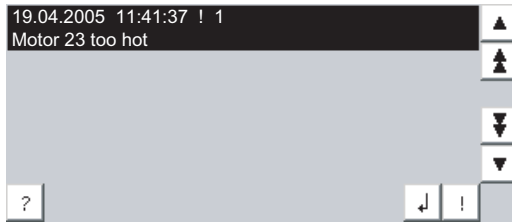

The buttons have the following functions:

Buttons	Functions
	Displaying infotext for an alarm.
	Process alarm.
	Acknowledge alarm.
	Select the next or previous alarm in the list.
	Scroll one page up or down.

Extended alarm view

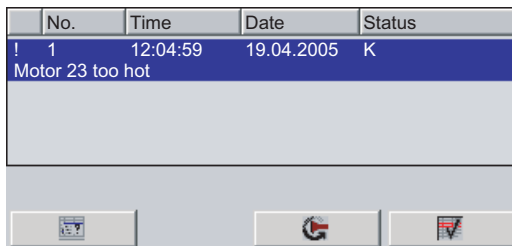

The buttons have the following functions:

Buttons	Functions
	Displaying infotext for an alarm.
	Process alarm.
	Acknowledge alarm.

Changing the column sequence and sorting in the extended alarm view

Depending on the configuration, you can change the column sequence and sorting order on HMI devices with touch operation.

- Change column sequence
 - Touch the column header which you wish to exchange with a different column header
 - Keeping the touch screen pressed, move the column heading to the column heading you wish to exchange it with

- Change sorting order

To change the sorting order of the alarms, touch the respective column header on the touch screen

Alarm class layout

The various alarm classes are identified in order to distinguish between them in the alarm view.

Symbol	Alarm class
!	Error
Without a symbol	Operation
Symbol depending on the configuration	User-defined alarm classes
S7	SIMATIC or SIMOTION diagnostic alarms
\$	System

The configuration engineer can change the symbols for the alarm classes. Please refer to your system documentation to check whether additional information on this subject is available there.

Alarm window

The alarm window is independent of the process screen. Depending on the configuration, the alarm window opens automatically as soon as a new alarm is pending for acknowledgment. The alarm window can be configured so that it only closes after all the alarms have been acknowledged.

The layout and the operation of the alarm window are the same as for the alarm view.

Please refer to your system documentation to check whether additional information on this subject is available there.

9.4 Display infotexts for an alarm

Displaying infotext

The configuration engineer can also provide infotext for alarms.

Procedure

Proceed as follows:

1. Touch the desired alarm in the alarm view or the alarm window.

The alarm is selected.

2. Touch the  button in the simple alarm view or  in the extended alarm view.

If configured, the infotext assigned to this alarm is displayed.

3. Close the screen for displaying the infotext by means of the  button.

See also

Displaying alarms (Page 223)

9.5 Acknowledge alarm

Requirements

The alarm to be acknowledged is displayed in the alarm window or the alarm view.

Procedure

Proceed as follows:

1. Touch the desired alarm in the alarm view or the alarm window.

The alarm is selected.

2. Touch the  button in the simple alarm view or  in the extended alarm view.

Alternative operation

Depending on the configuration, you can also acknowledge an alarm with a function key.

Result

The alarm is acknowledged. If the alarm belongs to an alarm group, all the alarms of the associated group are acknowledged.

Please refer to your system documentation to check whether additional information on acknowledgment and available alarm groups is available there.

9.6 Edit alarm

Introduction

The configuration engineer can assign additional functions to each alarm. These functions are executed when the alarm is processed.

Note



When you edit an unacknowledged alarm, it is acknowledged automatically.

Requirements

The alarm to be edited is displayed in the alarm window or the alarm view.

Procedure

Proceed as follows:

1. Touch the desired alarm in the alarm view or the alarm window. The alarm is selected.
2. Touch the  button in the simple alarm view or  in the extended alarm view.

Result

The system executes the additional functions of the alarm. Please refer to your system documentation to check whether additional information on this subject is available there.

Operating recipes

10.1 Overview

Introduction

Recipes are used when different variants of a product are manufactured with the same process. In this case, the product variants differ in terms of their type and quantity of the components, but not in terms of the manufacturing process sequence. The configuration engineer can store the combination of each individual product variant in a recipe.

Field of application

Recipes can be used everywhere the same product components are used in variable combinations to create different product variants.

Examples:

- Beverage industry
- Food processing industry
- Pharmaceutical industry
- Paint industry
- Building materials industry
- Steel industry

10.2 Structure of a recipe

Recipes

The recipe collection for the production of a product family can be compared to a file cabinet. A recipe which is used to manufacture a product corresponds to a drawer in a file cabinet.

Example:

In a plant for producing fruit juice, recipes are required for different flavors. There is a recipe, for example, for the flavors orange, grape, apple and cherry.

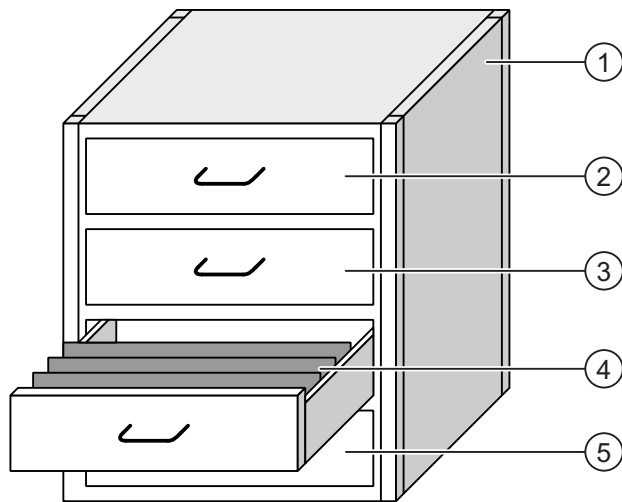

①	File cabinet	Recipe collection	Recipes for a fruit juice plant
②	Drawer	Recipe	Orange flavored drinks
③	Drawer	Recipe	Grape flavored drinks
④	Drawer	Recipe	Apple flavored drinks
⑤	Drawer	Recipe	Cherry flavored drinks

Recipe data records

The drawers of the file cabinet are filled with suspension folders. The suspension folders in the drawers represent records required for manufacturing various product variants.

Example:

Product variants of the flavor apple might be a soft drink, a juice or nectar, for example.

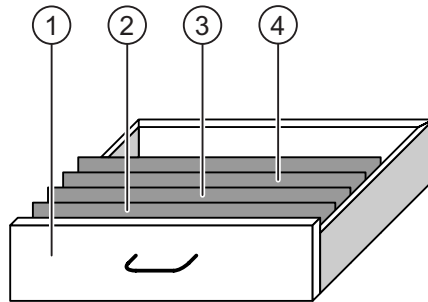

①	Drawer	Recipe	Product variants of apple flavored drinks
②	Suspension folder	Recipe data record	Apple drink
③	Suspension folder	Recipe data record	Apple nectar
④	Suspension folder	Recipe data record	Apple juice

Elements

In the figure showing the file cabinet, each suspension folder contains the same number of sheets. Each sheet in the suspension folder corresponds to an element of the recipe data record. All the records of a recipe contain the same elements. The records differ, however, in the value of the individual elements.

Example:

All drinks contain the same components: water, concentrate, sugar and flavoring. The records for soft drink, fruit juice or nectar differ, however, in the quantity of sugar used in production.

10.3 Recipes in the project

Overview

If recipes are used in a project, the following components interact:

- Recipe view / recipe screen

On the HMI device, recipes are displayed and edited in the recipe view or in a recipe screen.

- The recipe data records from the internal memory of the HMI device are displayed and edited in the recipe view.
- The values of the recipe tags are displayed and edited in the recipe screen.

Depending on the configuration, the values displayed in the recipe view are synchronized with the values of recipe tags.

- HMI device recipe memory

Recipes are saved in the form of data records in the HMI device recipe memory.

The recipe data can also be saved in recipe tags.

- Recipe tags

The recipe tags contain recipe data. When you edit recipes in a recipe screen, the recipe values are stored in recipe tags. Depending on the configuration, the values of the recipe tags are exchanged with the PLC.

The recipe tags can be synchronized with the recipe data records so that the same values are saved in both.

- Memory card

The memory card is an external storage medium for recipe data records. The recipe data records are exported from the HMI device recipe memory and are saved on the memory card in a *.csv file. The records can be reimported from the memory card to the recipe memory.

Data flow

The following figure shows the data flow in a project with recipes.

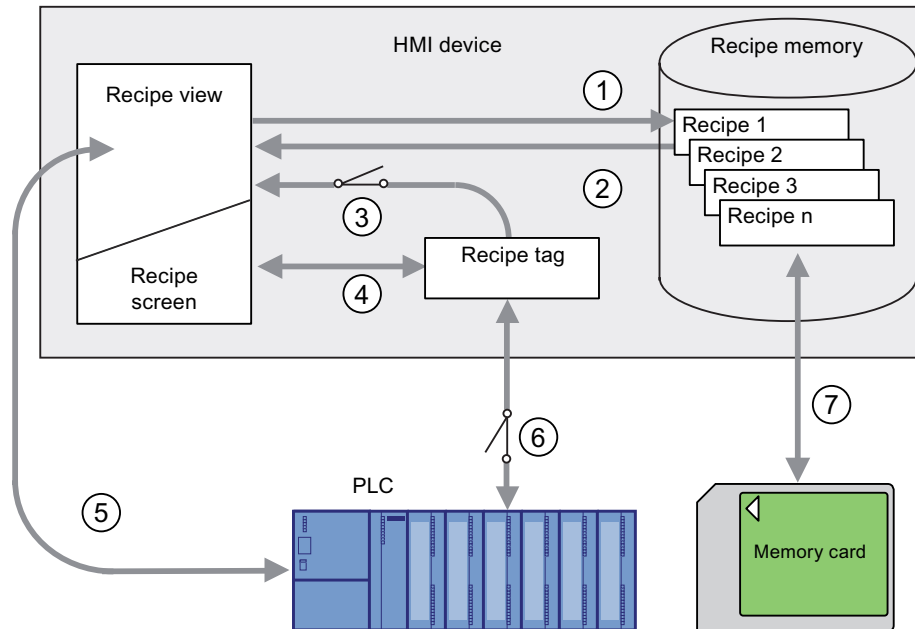

- ① Editing, saving or deleting a recipe data record
- ② Display recipe data record
- ③ Synchronize or do not synchronize recipe tags
- ④ Display and edit recipe tags in the recipe screen
- ⑤ Write records from the recipe view to the PLC or read records from the PLC and display them in the recipe view
- ⑥ Recipe tags are sent to the PLC online or offline
- ⑦ Export or import recipe data record to memory card

10.4 Displaying a recipe

Displaying recipes

You can display and edit recipes on the HMI device with a recipe view or recipe screen.

Recipe view

A recipe view is a screen object used to manage recipe data records. The recipe view shows recipe data records in tabular form.

Depending on the configuration, the recipe view is displayed as follows:

- As enhanced recipe view
- As simple recipe view

The configuration engineer also defines which operating elements are displayed in the recipe view.

Enhanced recipe view

The following figure shows an example of the enhanced recipe view.

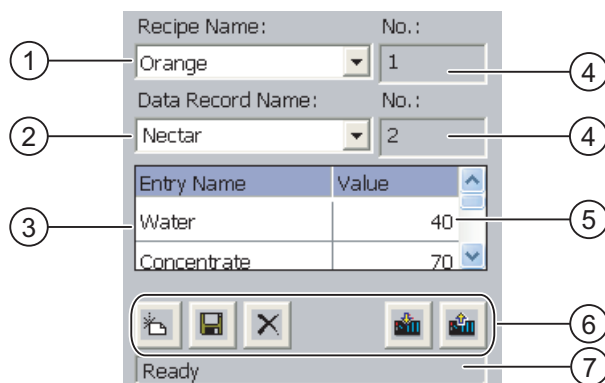

- ① Selection box for the recipe
- ② Selection box for the recipe data record
- ③ Element name
The element name designates a specific element in the recipe data record
- ④ Display field
This show the number of the selected recipe or the selected recipe data record
- ⑤ Value of the element
- ⑥ Buttons for editing a recipe data record
- ⑦ Status bar for display of the status messages

Simple recipe view

The simple recipe view consists of three areas:

- Recipe list
- Record list
- Element list

In the simple recipe view, each area is shown separately on the HMI device. Depending on the configuration, the simple recipe view starts with the recipe list or data record list.

The following figure shows an example of the record list.

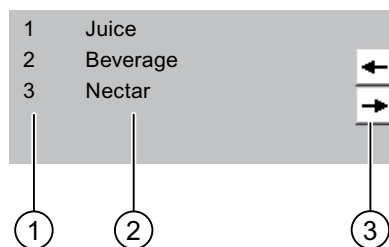

- ① Number of the recipe data record
- ② Recipe data records
- ③ Buttons for changing the displayed list and calling the menu

Display of values

NOTICE

Changing the recipe data record in the background

Applies to the processing of a recipe data record:

If values of the corresponding recipe data record are changed by a PLC job, the recipe view is not updated automatically.

To update the recipe view, reselect the respective recipe data record.

Recipe screen

A recipe screen allows the correlation between the plant and the recipe data to be displayed in graphic form. The configuration engineer combines I/O fields and screen objects to form a custom input screen. The configuration engineer can distribute the I/O fields of a recipe over several recipe screens, thus allowing recipe elements to be arranged by subject. The recipe screen can be operated using buttons configured accordingly.

The following figure shows an example of the recipe screen.

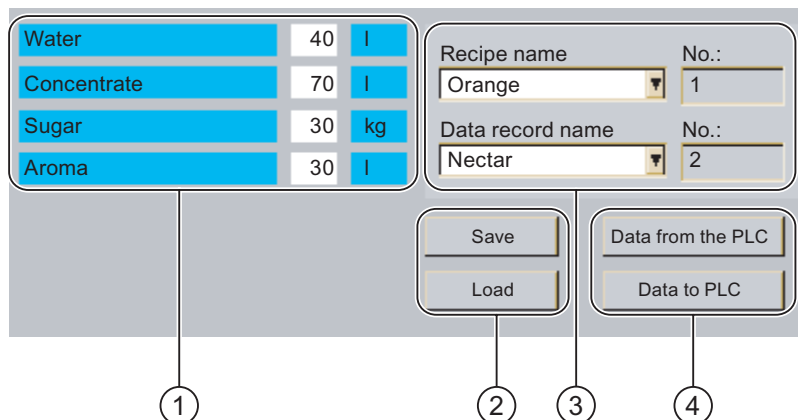

- ① Element name and associated values
The element name designates a specific element in the recipe data record
- ② Buttons for editing a recipe data record
- ③ Modified recipe view
- ④ Buttons for transferring recipe data

The values displayed or entered in the recipe screen are saved in recipe tags. The recipe values are exchanged with the PLC immediately or later via these tags.

A configured recipe view can itself be a component of a recipe screen. You must synchronize the tags in order to synchronize data between the tags of the recipe screen and the recipe data records displayed in the recipe view. Synchronization of tags is only possible in the enhanced recipe view.

Further information on this may be available in your plant documentation

10.5 Recipe values in the HMI device and the PLC

Introduction

You can change the values of a recipe on the HMI device and therefore influence the manufacturing process or a machine.

Depending on the configuration, the recipe values are displayed, edited and saved in different ways:

- If you are editing recipes with a recipe view in your project, the values are saved in recipe data records
- If you are editing recipes in a recipe screen in your project, the values are saved in recipe tags

Differences may occur between the display values in the recipe view and the values saved in the associated tags in an ongoing project when you edit recipes with a recipe view and in a recipe screen. To prevent this, the recipe data record values must be synchronized with the values of the recipe tags.

You have however the option to perform synchronization operations at any time. Synchronization only takes place if the configuration engineer has activated the respective settings for a recipe.

Note

Recipe tags can only be synchronized in the extended recipe view.

Synchronizing recipe tags

Synchronization of the recipe tags depends on the configuration:

- Automatic synchronization:

The values of the recipe view are synchronized with the associated recipe tags. In this case, changes to values in the recipe view have an immediate effect on the values of the associated recipe tags. The values are only synchronized, when an operating element that is outside the recipe view is operated.

- Synchronization by the user:

The values of the recipe view and the associated recipe tags are not synchronized automatically. The configuration engineer has assigned the same function to the  button or a different operating element in the recipe view. The recipe tags and the recipe view are only synchronized when you operate the buttons or the appropriate operating element.

Recipe tags online / offline

The configuration engineer can configure a recipe so that changes to the values of the recipe tags do not have an immediate effect on the current process.

Synchronization of the recipe values between the HMI device and the PLC depends on whether the configuration engineer has selected the settings "Tags online" or the setting "Tags offline" for a recipe.

- "Tags online":

This setting has the following effect:

- When you change recipe values in the recipe screen, these changes are applied immediately by the PLC and immediately influence the process
- If recipe values are changed in the PLC, the changed values are displayed immediately in the recipe screen

- "Tags offline":

With this setting, changed recipe values are not synchronized immediately between the HMI device and the PLC

In this case, the configuration engineer must configure operating elements for transferring the values to the PLC or reading them from the PLC in a recipe screen. The recipe values are only synchronized between HMI device and PLC when you operate the appropriate operating element

10.6 Operating the recipe view

10.6.1 Overview







Operation

The recipe view can be operated as follows:

- Enter values for the recipe elements
- Create recipe data records
- Save recipe data records or save them under a new name
- Delete recipe data records
- Synchronize values of the recipe view with the associated recipe tags
- Transfer recipe data records from the PLC and to the PLC

Operator controls of the recipe view

The following table shows the operator controls of the recipe view.

Buttons	Functions
	Creates a new recipe data record. If a start value is configured, it is shown in the text box.
	Saves the displayed values of the recipe data record. The storage location is predefined by the project.
	The recipe data record is saved under a different name irrespective of the recipe view. A dialog box opens in which the name is entered.
	The displayed recipe data record is deleted.
	The values of the recipe view are synchronized with the associated recipe tags. The values changed during editing are written to the associated recipe tags. Subsequently all the values of the tags are read out and updated in the table.
	The recipe values from the PLC are displayed in the recipe view.
	The values of the set recipe data record displayed in the recipe view are transferred to the PLC.

Operating the recipe screen

You operate the recipes in a recipe screen with the operator controls provided by the configuration engineer.

Please refer to your system documentation to check whether additional information on this subject is available there.

10.6.2 Creating a recipe data record

Introduction

You create a new recipe data record by modifying an existing record. You then save the modified data record under a new name.

Requirements

A screen with a recipe view is displayed.

Procedure

Proceed as follows:

1. If the recipe view contains several recipes: Select the recipe for which you want to create a new recipe data record.

2. Touch .

A new recipe data record with the next available number is created.

If you change the new data record number to an existing data record number, the existing data record is overwritten.

3. Enter values for the elements of the data record.

The elements of the recipe data record can be assigned default values depending on the configuration.

4. Touch .

5. Enter a name for the data record.

The data record is saved under the new name.

If the recipe data record already exists, a dialog is opened. In this dialog, specify whether the existing data record is to be overwritten.

Result

The new recipe data record is saved to the selected recipe.

See also

Recipes in the project (Page 232)

10.6.3 Editing a recipe data record

Introduction

Edit the values of the recipe data records and save them in a recipe view.

Synchronization with the PLC

If you want to display the current recipe values from the PLC in the recipe view, you first have to read the current values from the PLC with .

The values changed in the recipe view only become effective when the amended data record is transferred to the PLC by means of the  button.

Requirements

A screen with a recipe view is displayed.

Procedure

Proceed as follows:

1. If the recipe view contains several recipes: Select the recipe which contains the desired recipe data record.
2. Select the recipe data record you want to change.
3. Change the data record as required.
4. Save your changes by means of the  button.

If you want to save the recipe data record under a different name, touch the  key.

5. The recipe data record is saved.

Result

The edited recipe data record has now been saved in the selected recipe.

See also

Recipes in the project (Page 232)

10.6.4 Deleting a recipe data record

Introduction

You can delete all the data records of a recipe which are not required.

Requirements

A screen with a recipe view is displayed.

Procedure

Proceed as follows:

1. If the recipe view contains several recipes: Select the recipe which contains the desired recipe data record.
2. Select the recipe data record you want to delete.
3. Touch .

Result

The recipe data record is deleted.

See also

Recipes in the project (Page 232)

10.6.5 Synchronizing tags

Introduction

The values of the recipe elements can be saved to recipe tags, depending on the configuration.

Differences may occur between the display values in the recipe view and the actual values of tags in an ongoing project. Synchronize the tags to equalize such differences.

Synchronization always includes all the variables which belong to a recipe data record.

NOTICE
Changed tag name
Tags and the value of the recipe data record cannot be assigned to each other if the tag name of the tag to be synchronized has been changed. The tags in question are not synchronized.

Note

Recipe tags can only be synchronized in the enhanced recipe view.

Requirement

A screen with a recipe view is displayed.

Procedure

Proceed as follows:

1. If the recipe view contains several recipes: Select the recipe which contains the desired recipe data record.
2. Select the recipe data record you want to synchronize.
3. Touch .

Result

The elements of the recipe data record are synchronized with the recipe tags.

If the values of the recipe view and the tag do not match, the more current value is accepted.

See also

Recipes in the project (Page 232)

10.6.6 Reading a recipe data record from the PLC

Introduction

In the current project, the values which are also stored in the recipes in the HMI device can be changed directly in the plant. This is the case, for example, if a valve was opened further directly at the plant than is stored in the recipe. The values of the recipe data records saved in the HMI device possibly no longer match the values in the PLC.

To synchronize the recipe values, read the values from the PLC and display them in the recipe view.

Requirements

A screen with a recipe view is displayed.

Procedure

Proceed as follows:

1. If the recipe view contains several recipes: Select the recipe which contains the desired recipe data record.
2. Select the recipe data record to which you want to apply the values from the PLC.

3. Touch .

The values are read from the PLC.

4. If you want to store the displayed values in the HMI device, touch the  button.

Result

The values were read from the PLC, displayed on the HMI device and saved to the selected recipe data record.

See also

Recipes in the project (Page 232)

10.6.7 Transferring a recipe data record to the PLC

Introduction

In order for an edited recipe data record to take effect in the process, you must transfer the values to the PLC.

The display values in the recipe view are always transferred to the PLC.

Requirements

A screen with a recipe view is displayed.

Procedure

Proceed as follows:

1. If the recipe view contains several recipes: Select the recipe which contains the desired recipe data record.
2. Select the recipe data record whose values you want to transfer to the PLC.
3. Touch .

Result

The display values in the recipe view were transferred to the PLC and take effect in the process.

See also

Recipes in the project (Page 232)

10.7 Operating the simple recipe view

10.7.1 Overview

Introduction

The simple recipe view consists of three areas:

- Recipe list
- Record list
- Element list

You can use the context menu to operate each of these display areas.

Operation



The simple recipe view can be operated as follows:

- Enter values for the recipe elements
- Create recipe data records
- Save recipe data records or save them under a new name
- Delete recipe data records
- Transfer recipe data records from the PLC and to the PLC

Operator controls of the simple recipe view

Toggle between the display areas and the context menus to operate the simple recipe views.

The table below shows the operation of the display area.

Operation	Functions
Touching an entry	The next lower display area opens.
	The next higher display area opens.
	The context menu of the display area opens.

The table below shows the operation of the context menu.

Operation	Functions
	The menu is closed. The display area opens.
Touch the menu command	The menu command is executed.

Context menus of the simple recipe view

- Recipe list

No.	Menu command	Functions
0	New	A new recipe data record is created for the selected recipe. If a start value is configured, it is shown in the input field.
1	Displaying infotext	The infotext configured for the simple recipe view is displayed.
2	Open	The record list of the selected recipe opens.

- Record list

No.	Menu command	Functions
0	New	A new recipe data record is created for the selected recipe. If a start value is configured, it is shown in the input field.
1	Delete	The displayed record is deleted.
2	Save as	The selected record is saved under a different name irrespective of the simple recipe view. A dialog box opens in which the name is entered.
3	Rename	The selected record is renamed. A dialog box opens in which the name is entered.

- Element list

No.	Menu command	Functions
0	Save	The selected record is renamed.
1	To PLC	The display values of the selected record are transferred from the HMI device to the PLC.
2	From PLC	The recipe values from the PLC are displayed on the HMI device in the recipe view.
3	Save as	The data record is saved under the new name. A dialog box opens in which the name is entered.

Operating the menu

Touch the desired menu command. The command is executed.

Operating the recipe screen

You operate the recipes in a recipe screen with the operator controls provided by the configuration engineer.

Further information on this may be available in your plant documentation.

10.7.2 Creating a recipe data record

Introduction

Create a new recipe data record in the recipe list or in the record list. Then enter the values for the new record in the element list and save the record.

Requirements

A screen with a simple recipe view is displayed.

Procedure

Proceed as follows:

1. If the recipe list contains several recipes: Select the recipe for which you want to create a new recipe data record.
2. Open the recipe list menu.
3. Select the menu command "0 New".
Creates a new record
The element list of the new record opens.
4. Enter values for the elements of the data record.
The tags of the record can be assigned default values depending on the configuration.
5. Open the element list menu and select the menu command "0 Save".

6. Enter a name for the new record.

7. Confirm your entries.

If you change the new data record number to an existing data record number, the existing data record is overwritten.

Result

The new recipe data record is saved to the selected recipe.

See also

Recipes in the project (Page 232)

10.7.3 Editing a recipe data record

Introduction

Edit the values of the recipe data records in a simple recipe view.

Synchronization with the PLC

If you want to display the current recipe values from the PLC in the simple recipe view, you first have to read the current values from the PLC with the menu command "2 from PLC" in the element list.

The values changed in the recipe view only take effect in the PLC when you transfer the edited data record to the PLC with the menu command "1 to PLC".

Requirements

A screen with a simple recipe view is displayed.

Procedure

Proceed as follows:

1. If the recipe list contains several recipes: Select the recipe which contains the desired recipe data record.
2. Open the data record list.
3. Select the recipe data record you want to change.
4. Open the element list.
5. Change the values of the records as required.
6. Save your changes with the menu command "0 Save".

The recipe data record is saved.

Result

The edited recipe data record has now been saved in the selected recipe.

See also

Recipes in the project (Page 232)

10.7.4 Deleting a recipe data record

Introduction

You can delete all the data records which are not required.

Requirements

A screen with a simple recipe view is displayed.

Procedure

Proceed as follows:

1. If the recipe list contains several recipes: Select the recipe which contains the desired recipe data record.
2. Open the data record list.
3. Select the data record you want to delete.
4. Open the menu.
5. Select the menu command "1 Delete".

Result

The data record is deleted.

See also

Recipes in the project (Page 232)

10.7.5 Reading a recipe data record from the PLC

Introduction

The values of recipe elements are exchanged with the PLC via tags.

In the current project, the values which are also stored in the recipes in the HMI device can be changed directly in the plant. This is the case, for example, if a valve was opened further directly at the plant than is stored in the recipe. The values of the tags on the HMI device possibly no longer match the values in the PLC.

To synchronize the recipe values, read the values from the PLC and display them in the recipe view.

Requirements

A screen with a simple recipe view is displayed.

Procedure

Proceed as follows:

1. If the recipe list contains several recipes: Select the recipe which contains the desired recipe data record.
2. Select the element list of the recipe data record to which you want to apply the values from the PLC.
3. Open the menu.
4. Select the menu command "2 from PLC".
The values are read from the PLC.
5. If you want to save the display values in the HMI device, select the menu command "0 Save".

Result

The values were read from the PLC, displayed on the HMI device and saved to the selected recipe data record.

See also

Recipes in the project (Page 232)

10.7.6 Transferring a recipe data record to the PLC

Introduction

In order for an edited recipe data record to take effect in the process, you must transfer the values to the PLC.

The display values in the recipe view are always transferred to the PLC.

Requirements

A screen with a simple recipe view is displayed.

Procedure

Proceed as follows:

1. If the recipe list contains several recipes: Select the recipe which contains the desired recipe data record.
2. Select the element list of the recipe data record whose values you want to transfer to the PLC.
3. Open the menu.
4. Select the menu command "1 To PLC".

Result

The values of the recipe data record were transferred to the PLC and take effect in the process.

See also

Recipes in the project (Page 232)

10.8 Exporting a recipe data record

Introduction

You can export one or more recipe data records to a CSV file, depending on the configuration. After export, the values in the recipe data record can be further processed in a spreadsheet program such as MS Excel. The degree to which you can influence the export depends on the configuration:

Requirements

- A screen with a recipe view is displayed
- An operating element with the function "Export record" has been configured.
- The following tags are configured equally in the recipe view and for the "Export record" operating element.
 - Recipe number
 - Data record number

Procedure

Proceed as follows:

1. If the recipe view contains several recipes: Select the recipe which contains the desired recipe data record.
2. Select the recipe data record you want to export.
3. Operate the operating element which was configured for export, for example the "Export data record" button.

The data record is exported as a CSV file to an external data medium.

Further information on this may be available in your plant documentation

Result

The recipe data record is exported.

10.9 Importing a recipe data record

Introduction

You can import values from a CSV file to a recipe data record, depending on the configuration.

Requirements

- An operating element with the function "Import data record" has been configured, for example a button
- A screen with a recipe view is displayed

Procedure

Proceed as follows:

1. If the recipe view contains several recipes: Select the recipe which contains the recipe data record to be imported.
2. Operate the operating element with the function "Import data record".

The record is imported from an external data medium as a CSV file and then displayed in the recipe view after import.

Result

The imported recipe data record is saved on the HMI device.

Deviating structure

If the structure of the CSV file differs from the structure of the recipe, deviations are handled as follows:

- Any additional values in the CSV file will be rejected
- The system applies the configured default value to the recipe data record if the CSV file contains an insufficient number of values
- If the CSV file contains values of the wrong data type, the configured default value is set in the recipe data record

Example:

The imported CSV file contains values that were entered as floating point numbers

However, the corresponding tag expects an integer value. In this case, the system discards the imported value and uses the configured default

10.10 Examples

10.10.1 Entering a recipe data record

Introduction

You would like to enter production data on the HMI device without interrupting the process in the machine or plant. For this reason, the production data should not be transferred to the PLC.

Procedure

Proceed as follows:

1. Call the recipe view or a recipe screen.
2. Select the desired recipe data record.
3. Enter the values of the elements.
4. Save the recipe data record.

The recipe data record is saved in the internal memory of the HMI device.

The following figure shows the data flow schematically.

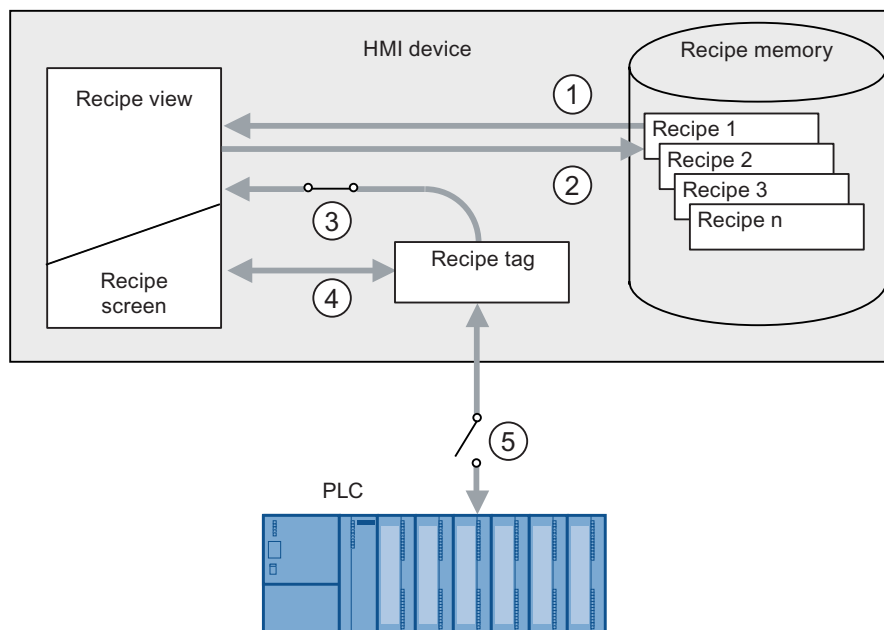

- ① Display recipe data record
- ② Save recipe data record
- ③ Tags are synchronized
- ④ Display and edit recipe tags in the recipe screen
- ⑤ Tags are offline

10.10.2 Manual production sequence

Introduction

You request the production data of different workpieces from the PLC and display this data on the screen of the HMI device for inspection. You want to correct the transferred production data in the recipe view or the recipe screen if necessary.

Procedure

A scanner connected to the PLC reads the barcode of a workpiece. The barcode names correspond to the names in the recipe data record. Based on the barcode name, the PLC can read the required recipe data record. The recipe data record is displayed for inspection on the HMI device. You can now edit and save the recipe data record. Then transfer the edited recipe data record to the PLC again.

The following figure shows the data flow schematically.

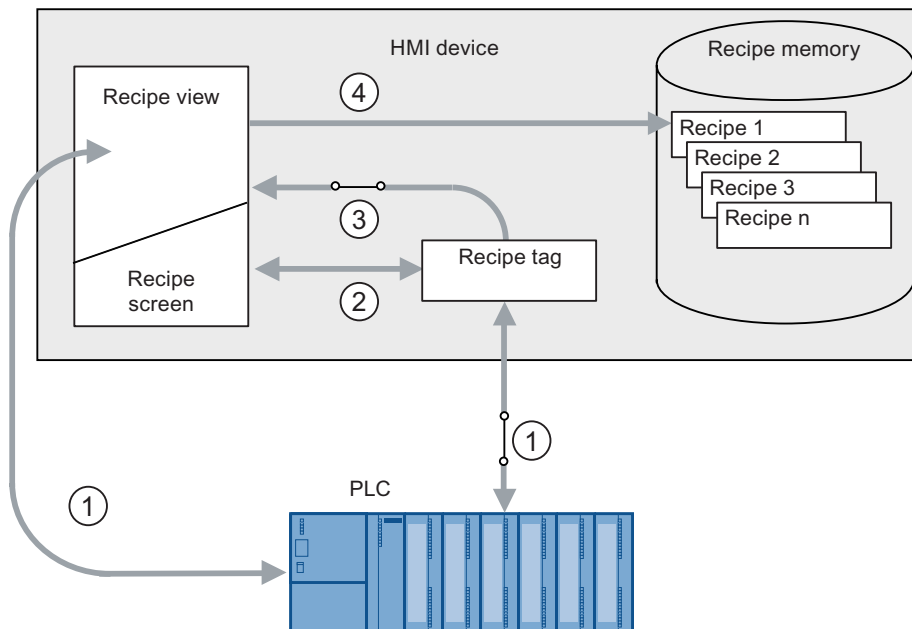

- ① The recipe data record is read from the PLC and written to the PLC again following changes
- ② Display and edit recipe tags in the recipe screen
- ③ Tags are synchronized
- ④ Recipe data records are saved in the recipe memory of the HMI device

Maintenance and care

11.1 Maintenance and care

Scope of maintenance

The HMI device is designed for maintenance-free operation. The touch screen and keyboard membrane should nevertheless be cleaned regularly.

Preparation

 CAUTION
Inadvertent operation Always switch off the HMI device before cleaning it. This will ensure that you do not trigger functions unintentionally when you touch the keys.

Requirements

Use a cleaning cloth dampened with a cleaning agent to clean the equipment. Only use water with a little liquid soap or a screen cleaning foam.

CAUTION
Do not clean the HMI device with compressed air or steam jet blowers. Never use aggressive solvents or scouring powder.

Procedure

Proceed as follows:

1. Switch off the HMI device.
2. Spray the cleaning solution onto a cleaning cloth.
Do not spray directly onto the HMI device.
3. Clean the HMI device.
When cleaning the display wipe from the screen edge inwards.

11.2 Spare Parts and Repairs

Repairs

In case of repair, the HMI device must be shipped to the Return Center in Fürth. Repairs may only be carried out at the Return Center in Fürth.

Depending on the work necessary to repair the device, the Center may decide to give you a credit note. In this case, it is your responsibility to order a new device.

The address is:

Siemens AG
Industry Sector
Return Center
Siemensstr. 2
90766 Fürth, Germany

Service pack

A service pack can be ordered for servicing purposes.

The service pack includes:

- Plugs for the cable duct (only for Mobile Panel 177)
- 2 x screw joints for connection box
- 1 set of screws for connection box cover
- 2 x plug-in terminal strips (12-pin)
- 1 plug-in terminal strip (three-set block)
- Mobile Panel 277 enclosure

The service pack can be ordered from your Siemens representative.

Replacement key set

If necessary, you can order a replacement key set from your Siemens representative.

Service & Support on the Internet

Service & Support provides additional comprehensive information on SIMATIC products through online services at "<http://support.automation.siemens.com>":

- On-site service
- Repairs
- Replacement parts and lots more.

Technical specifications

12.1 Dimension drawings

12.1.1 Mobile Panel 277 8"

Front view

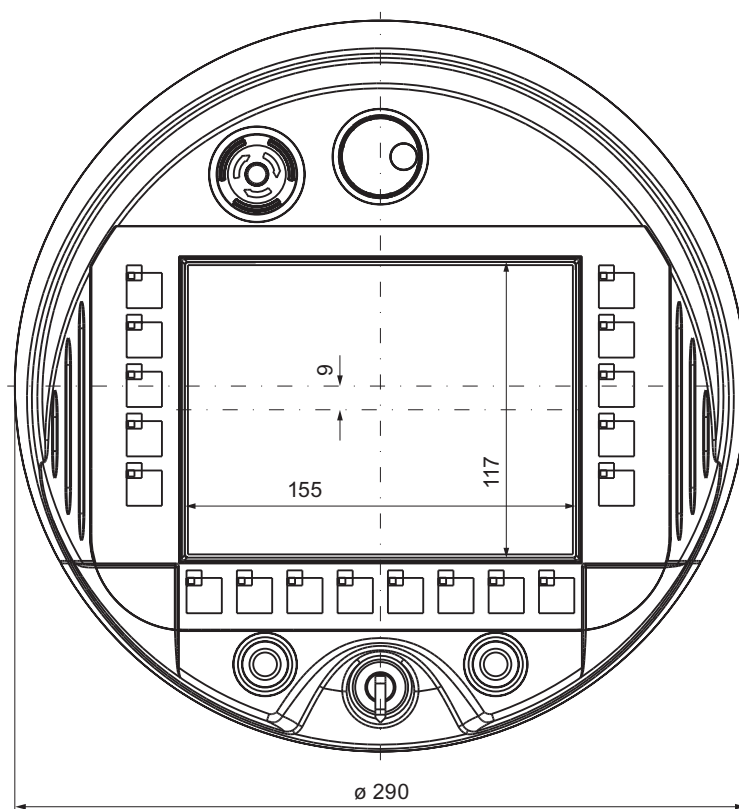

All specifications in mm

Side view

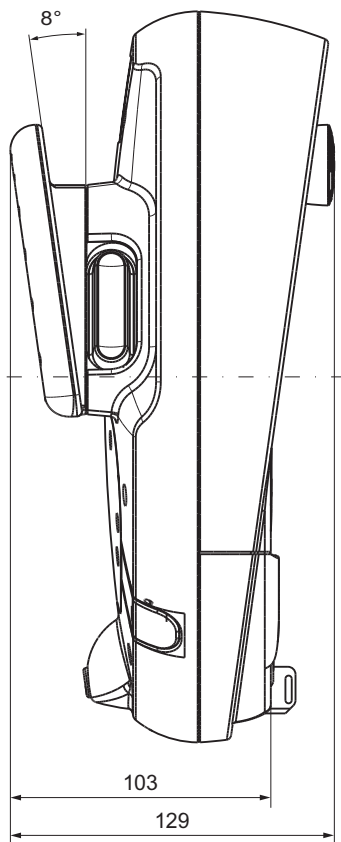

All specifications in mm

12.1.2 Mobile Panel 277 10"

Front view

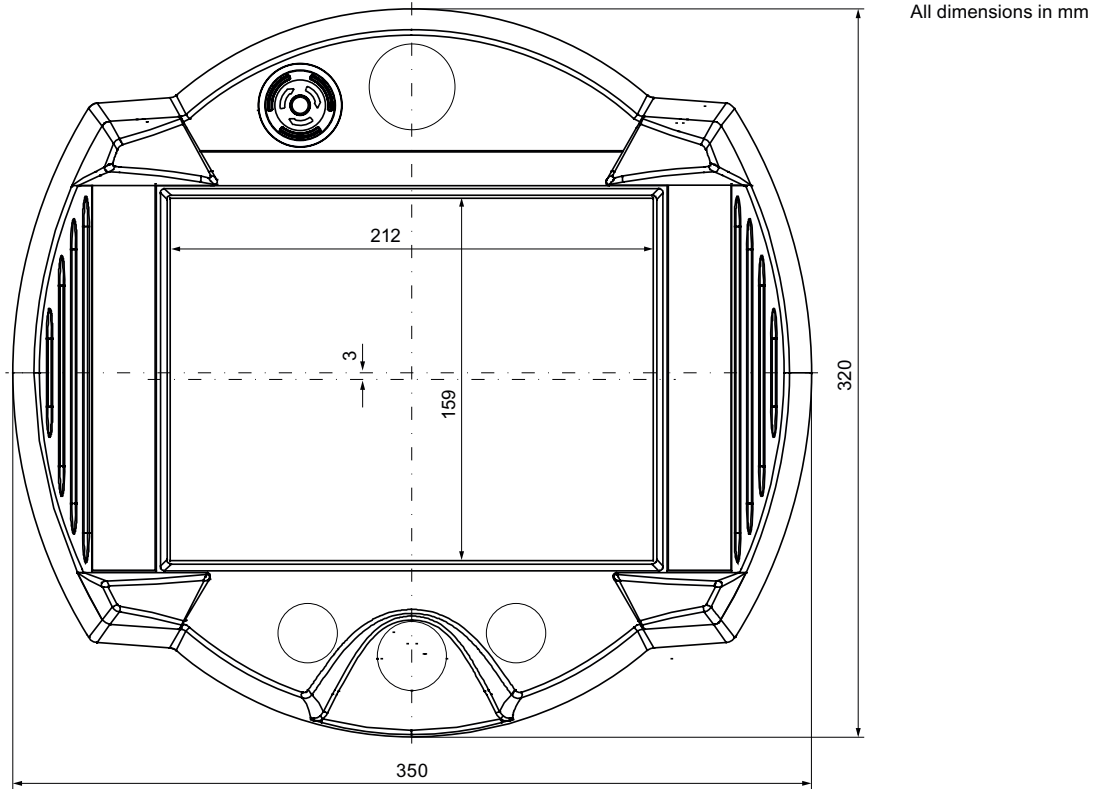

Side view

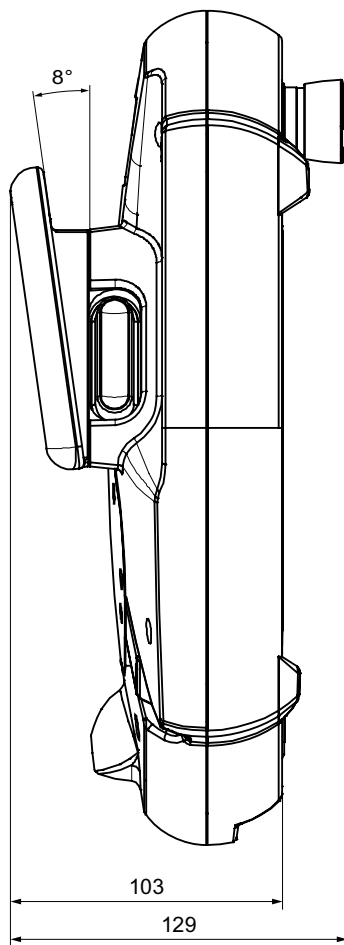

All dimensions in mm

12.1.3 Wall holder

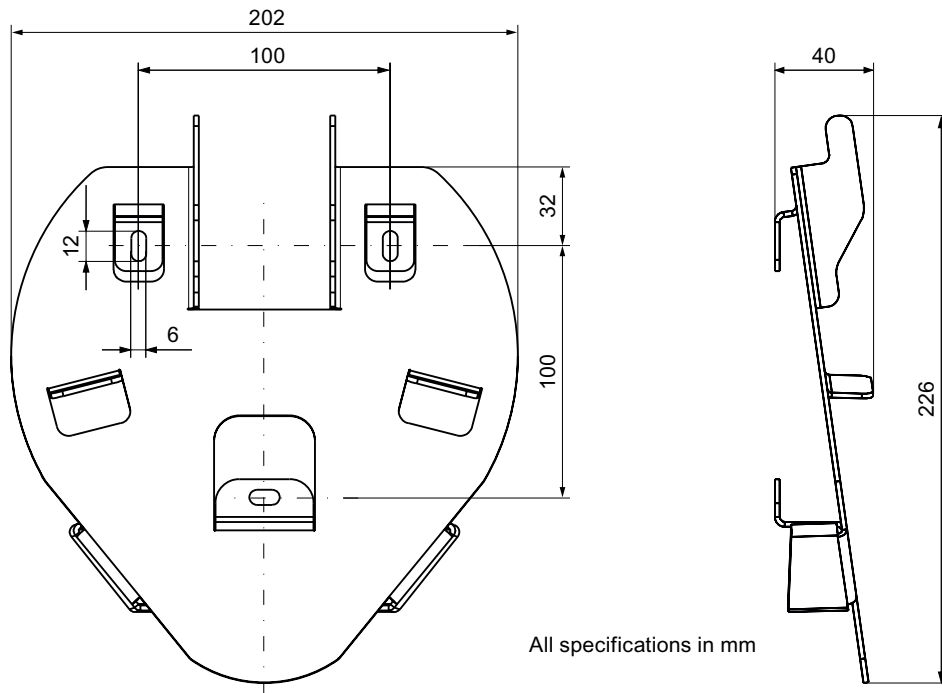

12.1.4 Connection box DP

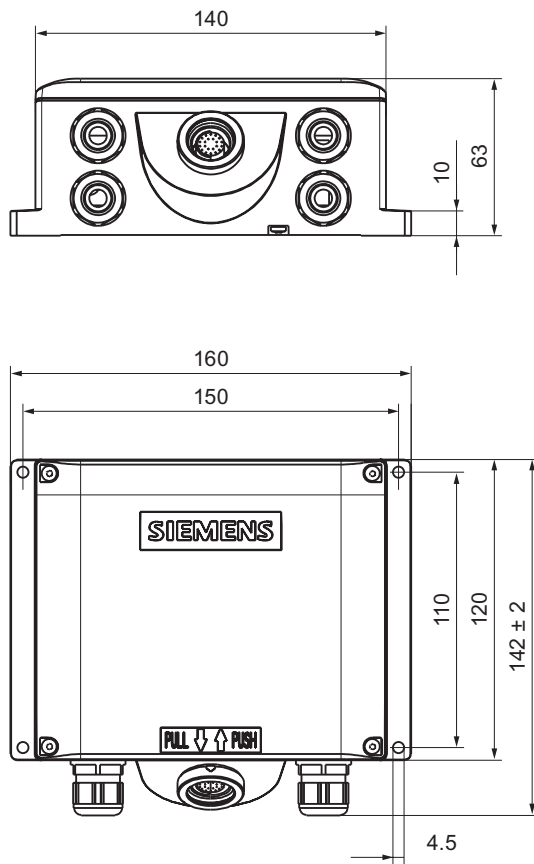

All specifications in mm

12.1.5 Connection box PN

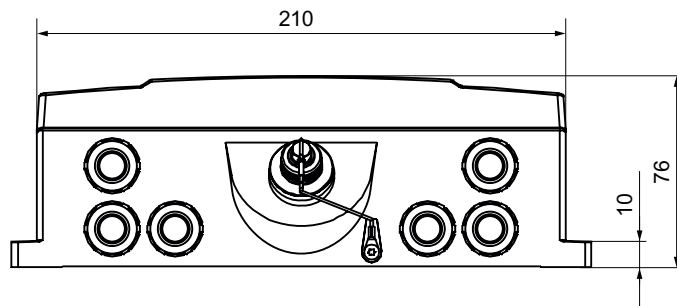

All specifications in mm

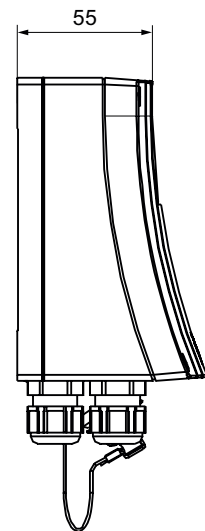
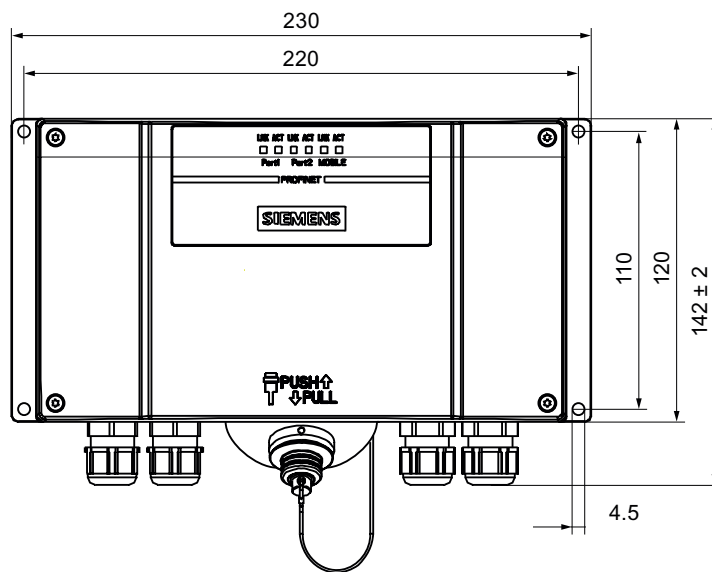

12.2 Specifications

12.2.1 Mobile Panel 277 8"

HMI device

Weight without packing	Approx. 1.7 kg, max. 1.8 kg
------------------------	-----------------------------

Display

Type	Color TFT-LC Display
Display area, active	151.66 mm x 113.74 mm (7.5")
Resolution	640 x 480 pixels
Colors, displayable	64k colors
Brightness control	Yes
Back-lighting	CCFL
Half Brightness Life Time, typical	50,000 h

Input unit

Type	Touch screen, analog, resistive Membrane keyboard
Function keys	18, with LEDs
Enabling button	2-circuit, 3-level Connection voltage: 24 VDC amperage, max.: 400 mA Amperage, min.: 10 mA
STOP button (optional)	2-circuit Connection voltage: 24 VDC Amperage, max.: 500 mA Amperage, min.: 10 mA These are normally closed contacts.
Handwheel (optional)	1 50 pulses per rotation
Key-operated switch (optional)	1 3 switch settings
Illuminated pushbutton (optional)	2 LED separately controllable

Memory

Application memory	6 MB
--------------------	------

Ports

1 x RS 485	Max. 12 Mbit/s
1 x USB	<ul style="list-style-type: none"> • USB host; conforms to USB standard 1.1 (supporting low-speed and full-speed USB devices) • Maximum load 500 mA
1 x RS 45	For PROFIBUS DP
1 x plug-in terminal strips (10-pin)	For PROFIBUS DP
1 x RS 45	For PROFINET
1 x plug-in terminal strips (12-pin)	For PROFINET

Supply voltage

Supply voltage	Via connection box
----------------	--------------------

Additional specifications

Fall height	Max. 1.2 m
Buffer time with internal clock	
<ul style="list-style-type: none"> • Without rechargeable battery • With rechargeable battery 	<p>Approx. 3 days</p> <p>Approx. 6 months</p>

12.2.2 Mobile Panel 277 10"

HMI device

Weight without packing	Approx. 2.3 kg
------------------------	----------------

Display

Type	Color TFT-LC Display
Display area, active (W x H)	211.2 mm x 158.4 mm (10")
Resolution	800 x 600 pixels
Colors, displayable	64k colors
Brightness control	Yes
Back-lighting	CCFL
Half Brightness Life Time, typical	50,000 h

Input unit

Type	Touch screen, analog, resistive
Enabling button	2-circuit, 3-level Connection voltage: 24 VDC Amperage, max.: 400 mA Amperage, min.: 10 mA
STOP button (optional)	2-circuit Connection voltage: 24 VDC Amperage, max.: 500 mA Amperage, min.: 10 mA These are normally closed contacts.

Memory

Application memory	6 MB
--------------------	------

Ports

1 x RS 485	Max. 12 Mbit/s
1 x USB	<ul style="list-style-type: none"> • USB host; conforms to USB standard 1.1 (supporting low-speed and full-speed USB devices) • Maximum load 500 mA
1 x RS 45	For Ethernet
1 x plug-in terminal strips (12-pin)	For Ethernet

Supply voltage

Supply voltage	Via connection box
----------------	--------------------

Additional specifications

Fall height	Max. 1 m
Buffer time with internal clock <ul style="list-style-type: none"> • Without rechargeable battery • With rechargeable battery 	Approx. 3 days Approx. 6 months

12.2.3 Rechargeable buffer battery

The following technical specifications are in effect for all new batteries. The batteries are delivered uncharged.

Type	Lithium ion accumulator
Bridging time	10 min
Charging cycles	500
Charging time	Approx. 5 h

Number of changes between connection boxes	
With fully charged battery	5 changes
With empty battery after a charging time of 1 h	2 changes

Please note that a battery is subject to a natural self-discharge. The self-discharge can lead to a complete discharge over long periods of disuse.

12.2.4 Connection box DP

Weight

Weight without packing	Approx. 500 g
------------------------	---------------

Supply voltage

Nominal voltage	+24 VDC
Range, permissible	20.4 to 28.8 V (-15 %, +20 %)
Transients, maximum permissible	35 V (500 ms)
Time between two transients, minimum	50 s
Power consumption connection box DP without mobile panel	
<ul style="list-style-type: none"> • Typical • Constant current, maximum • Power on current surge I^2t 	<ul style="list-style-type: none"> • Approx. 100 mA • Approx. 150 mA • Approx. 0.5 A²s
Power consumption connection box DP with mobile panel	
<ul style="list-style-type: none"> • Typical • Constant current, maximum • Power on current surge I^2t 	<ul style="list-style-type: none"> • Approx. 600 mA • Approx. 750 mA • Approx. 0.6 A²s
Enabling button	
<ul style="list-style-type: none"> • Connection voltage • Amperage, max. • Amperage, min. 	<ul style="list-style-type: none"> • 24 VDC • 400 mA • 10 mA

STOP button (optional)	
<ul style="list-style-type: none"> • Connection voltage • Amperage, max.: • Amperage, min.: 	<ul style="list-style-type: none"> • 24 VDC • 500 mA • 10 mA
Fuse, internal	Electronic
Current load PLC-accompanying signals	Max. 100 mA
Recovery time	After 1 s

Note

Recovery time

Wait for approximately one second after you have removed the connecting cable from the connection box before you plug the connecting cable back into the connection box.

Power failure

It is necessary to remove and replace the connection cable in the event of power failures lasting less than a second in order to eliminate possible malfunctions.

12.2.5 Connection box PN

Weight

Weight without packing	Approx. 700 g
------------------------	---------------

Supply voltage

Nominal voltage	+24 VDC
Range, permissible	20.4 to 28.8 V (–15 %, +20 %)
Transients, maximum permissible	35 V (500 ms)
Time between two transients, minimum	50 s
Power consumption connection box PN without Mobile Panel	
<ul style="list-style-type: none"> • Typical • Constant current, maximum • Power on current surge I²t 	<ul style="list-style-type: none"> • Approx. 100 mA • Approx. 150 mA • Approx. 0.5 A²s
Power consumption connection box PN with Mobile Panel	
<ul style="list-style-type: none"> • Typical • Constant current, maximum • Power on current surge I²t 	<ul style="list-style-type: none"> • Approx. 600 mA • Approx. 750 mA • Approx. 0.6 A²s
Enabling button	
<ul style="list-style-type: none"> • Connection voltage • Amperage, max. • Amperage, min. 	<ul style="list-style-type: none"> • 24 VDC • 400 mA • 10 mA

STOP button (optional)	
<ul style="list-style-type: none"> • Connection voltage • Amperage, max.: • Amperage, min.: 	<ul style="list-style-type: none"> • 24 VDC • 500 mA • 10 mA
Fuse, internal	Electronic
Current load PLC-accompanying signals	Max. 100 mA
Recovery time	After 1 s

Note

Recovery time

Wait for approximately one second after you have removed the connecting cable from the connection box before you plug the connecting cable back into the connection box.

Power failure

It is necessary to remove and replace the connection cable in the event of power failures lasting less than a second in order to eliminate possible malfunctions.

12.3 Mobile Panel 277 port assignments

12.3.1 RS 485 (IF 2)

Sub-D socket, 9-pin, with screw lock

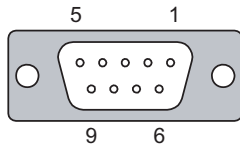

RS 485 port pin assignment

Pin	Assignment
1	n. c.
2	GND 24 V
3	Data channel B (+)
4	n. c.
5	GND 5 V, floating
6	+5 VDC, floating
7	+24 VDC, out (max. 100 mA)
8	Data channel A (-)
9	n. c.

12.3.2 USB

USB socket

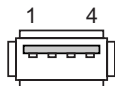

Pin assignment of the USB port

Pin	Assignment
1	+5 VDC, out, max. 500 mA
2	USB-DN
3	USB-DP
4	GND

12.3.3 RJ45 for connecting cable DP

RJ45 plug connector, 8-pin

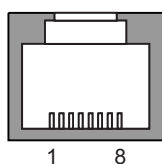

Pin assignment of the RJ45 connector for the connecting cable DP

Pin	Assignment
1	RxD-B
2	RxD-A
3	CTS-B/ID-
4	RTS-B/IC-
5	RTS-A/IC+
6	CTS-A/ID+
7	TxD-B
8	TxD-A

12.3.4 RJ45 for connecting cable PN

RJ45 plug connector, 8-pin

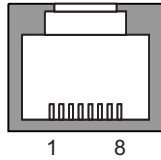

Pin assignment of the RJ45 connector for the connecting cable PN

Pin	Assignment
1	TD+
2	TD-
3	RD+
4	n. c.
5	n. c.
6	RD-
7	ICD+
8	ICD-

12.3.5 Post connector for connecting cable DP

Post connector, 10-pin

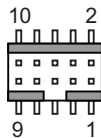

Pin assignment of the post connector for the connecting cable DP

Pin	Assignment	Circuit
1	+24 VDC	Power supply
2	GND 24 V	
3	Stop 23	Stop circuit
4	Stop 24	
5	Stop 13	
6	Stop 14	
7	Enable 1+	Enable circuit
8	Enable 1-	
9	Enable 2+	
10	Enable 2-	

12.3.6 Post connector for connecting cable PN

Post connector, 12-pin

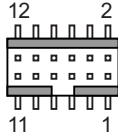

Pin assignment of the post connector for the connecting cable PN

Pin	Assignment	Circuit
1	+24 VDC	Power supply
2	GND 24 V	
3	Stop 23	Stop circuit
4	Stop 24	
5	Stop 13	
6	Stop 14	
7	Enable 1+	Enable circuit
8	Enable 1-	
9	Enable 2+	
10	Enable 2-	
11	ICD+	Box ID
12	ICD-	

12.4 Port assignment on the connection box DP

Location of the ports

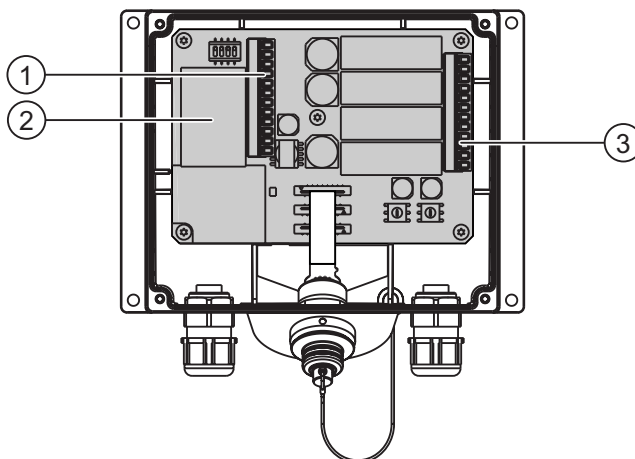

- ① Terminal strip 1
- ② Fast connector
- ③ Terminal strip 2

CAUTION

When connecting the cables to the terminal strips ensure that the assignments for terminal strips 1 and 2 are not reversed.

Terminal strip 1, 12-pin

IF1 and the power supply are connected to the terminal strip. The terminal strip has a mechanical coding, in order to prevent mix up with terminal strip 2.

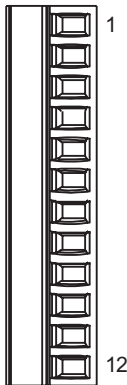

Assignment of terminal strip 1

Pin	RS 232 IF 1A 9-pin post	RS 232 IF 1A 15-pin socket	RS 422 IF 1B 9-pin socket	RS 485 IF 1B 9-pin socket	Power supply
1	CTS (8)	CTS (5)	n. c.	n. c.	n. c.
2	RTS (7)	RTS (10)	n. c.	n. c.	n. c.
3	TxD (3)	TxD (4)	n. c.	n. c.	n. c.
4	RxD (2)	RxD (3)	n. c.	n. c.	n. c.
5	M (5)	M (15)	M (5)	M (5)	n. c.
6	n. c.	n. c.	TxD+ (3)	Bus + (B) (3)	n. c.
7	n. c.	n. c.	TxD- (8)	Bus- (A) (8)	n. c.
8	n. c.	n. c.	RxD+ (4)	n. c.	n. c.
9	n. c.	n. c.	RxD- (9)	n. c.	n. c.
10	PE	PE	PE	PE	PE
11	n. c.	n. c.	n. c.	n. c.	M24
12	n. c.	n. c.	n. c.	n. c.	P24

The values in parentheses in the table refer to the pin numbers in the WinCC flexible Online Help for the standard cables described for the individual couplings.

Fast Connector, 4-pin

The connection box contains two Fast Connectors for connecting the PROFIBUS DP data cables.

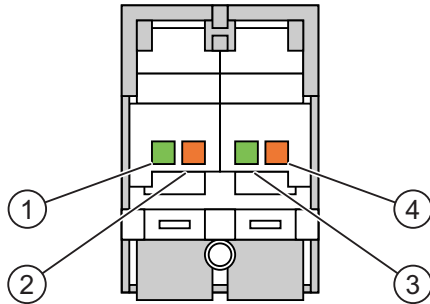

Pin assignment of the Fast Connector

Pin	Assignment
1	LTG-A (-) IN
2	LTG-B (+) IN
3	LTG-A (-) OUT
4	LTG-B (+) OUT

See also

Port assignment on the connection box DP and connection box PN (Page 276)

12.5 Port Assignment on the Connection Box PN

Location of the ports

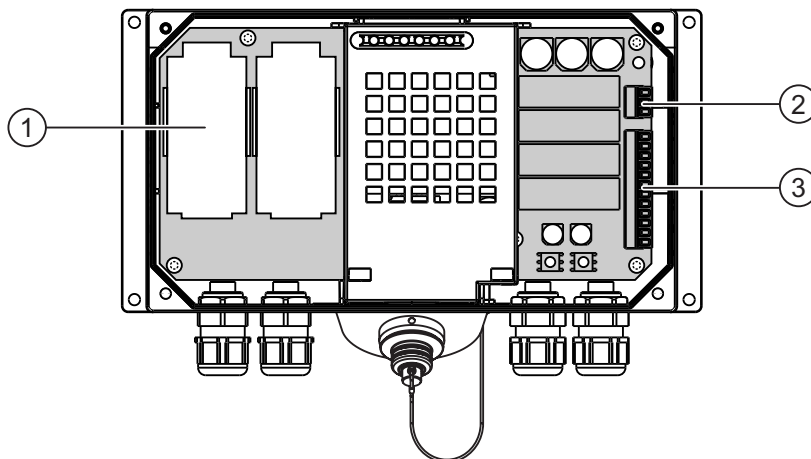

- ① Fast connector
- ② Terminal strip 1
- ③ Terminal strip 2

Fast Connector, 4-pin

The connection box contains two Fast Connectors for connecting the PROFINET data cables.

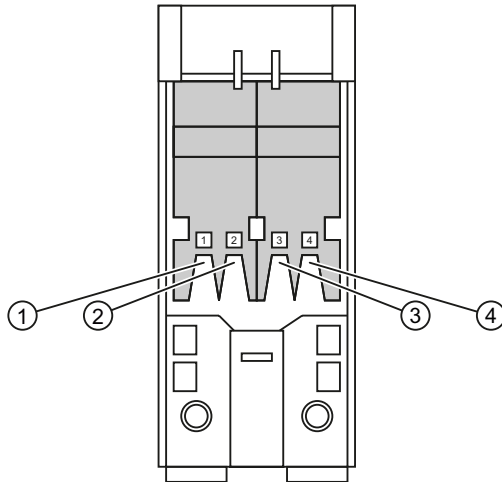

Assignment of 4-pin fast connector:

Pin	Assignment
1	RD+
2	TD+
3	RD-
4	TD-

Terminal strip 1, for power supply, 3-pin



Assignment of 3-pin terminal strip 1:

Pin	Power supply
1	PE
2	M24
3	P24

12.6 Port assignment on the connection box DP and connection box PN

Terminal strip 2, 12-pin

The safety and additional functions are connected to this terminal strip. The terminal strip has a mechanical coding, in order to prevent mix up with terminal strip 1.

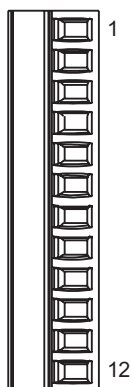

Assignment of terminal strip 2

Pin	Connection box Plus	Connection box Basic	Circuit
1	STOP13	STOP13	STOP button
2	STOP14	STOP14	See also post connectors
3	STOP23	STOP23	
4	STOP24	STOP24	
5	CTL31 ¹⁾	n. c.	PLC-accompanying signals
6	CTL32 ¹⁾	n. c.	
7	PRESENT31 ²⁾	24 VDC, if active	
8	PRESENT32	n. c.	
9	ENABLE2+		Enabling button
10	ENABLE1-		See also post connectors and connection examples
11	ENABLE1+		
12	ENABLE2-		

¹⁾ Active, if Emergency Stop pressed

²⁾ Active, if Mobile panel connected

The "STOP button pressed" signal is not available on the connection box Basic.

The "STOP button pressed" signal has no error detection and, therefore, must not be used for safety-critical applications!

Signal "Mobile panel connected" on a SIMATIC S7

Mobile panel on the connection box	Signal at the digital input of a SIMATIC S7
Not connected	"0"
Connected	"1"

Note

Output "Mobile panel connected"

The output "Mobile panel connected" on the connection box Basic is associated with the power supply. On the connection box Plus, this output is managed on a dual-pole relay.

Observe the following points when connecting the "Mobile panel connected" signal:

- Connect terminal strip 2, pin 7 of the connection box to the digital input of the PLC
- Connection box Basic
Terminal strip 2, pin 8 of the connection box remains free
- Connection box Plus
Terminal strip 2, pin 8 must be fed with +24 V

Connection box Plus wiring examples

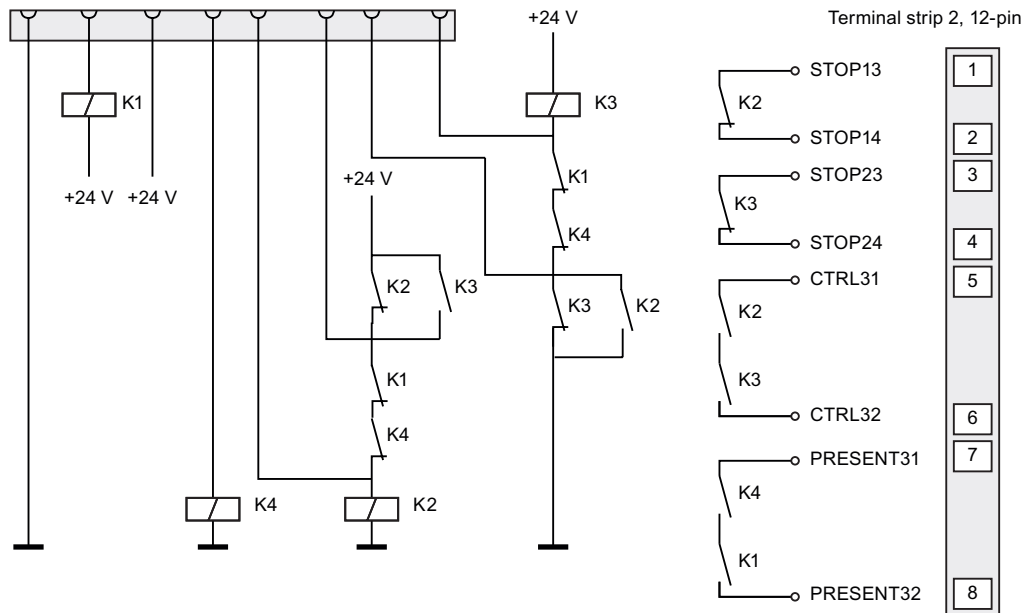

Mobile Panel 277 not connected and power supply switched on

12.6 Port assignment on the connection box DP and connection box PN

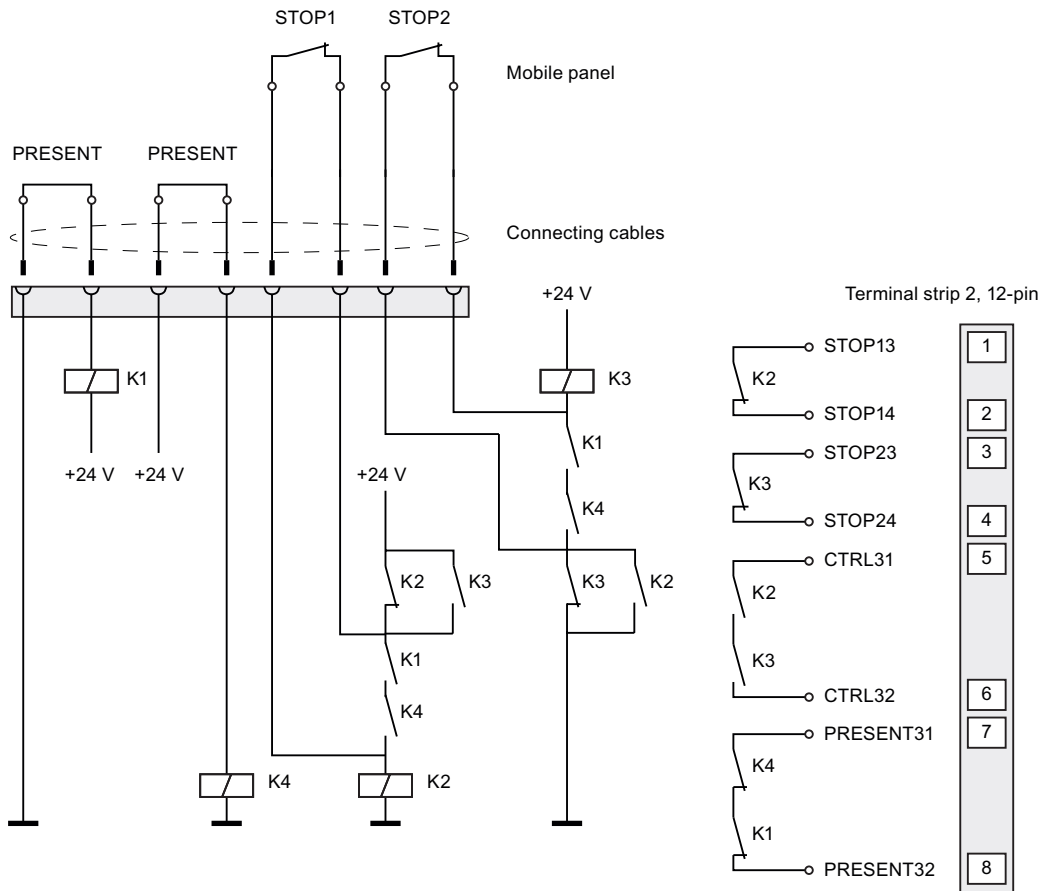

Mobile Panel 277 connected, power supply switched on and Emergency Stop inactive

12.6 Port assignment on the connection box DP and connection box PN

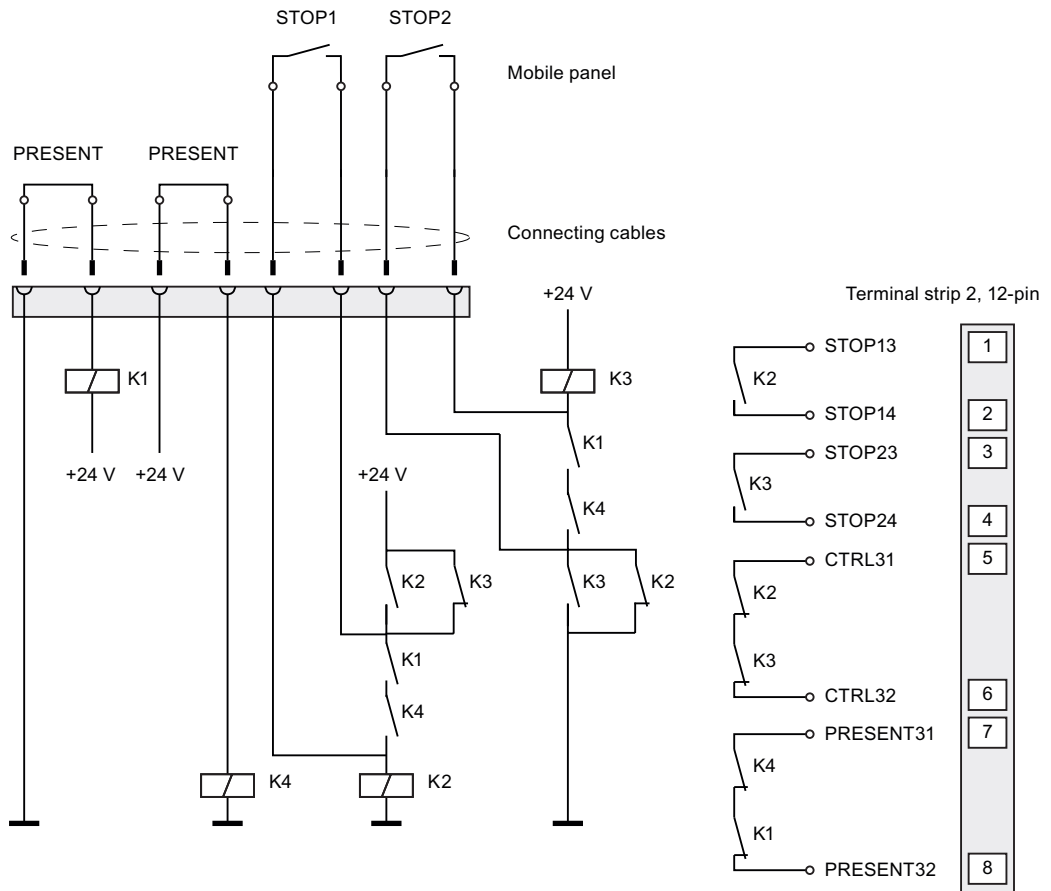

Mobile Panel 277 connected, power supply switched on and Emergency Stop active

12.6 Port assignment on the connection box DP and connection box PN

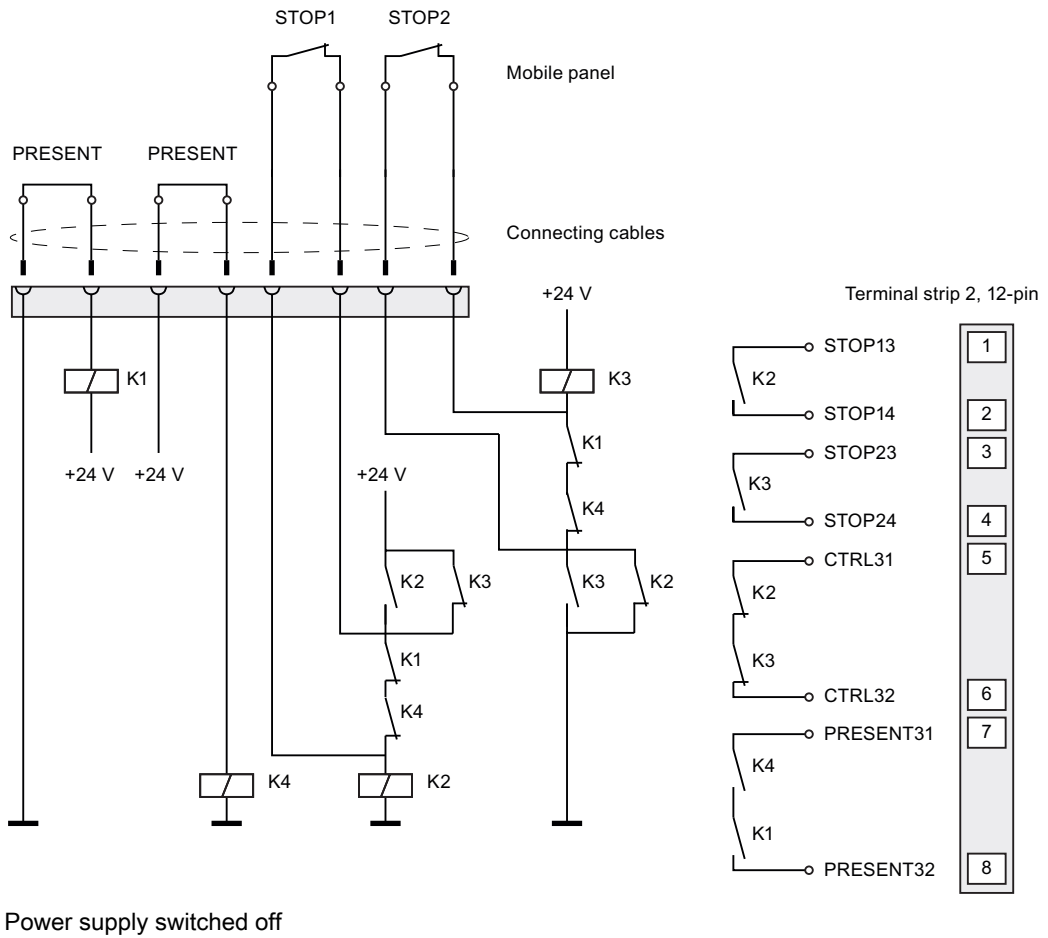

Connection box Basic wiring examples

In contrast to the connection box Plus, the following circuit diagram applies to the connection box Basic.

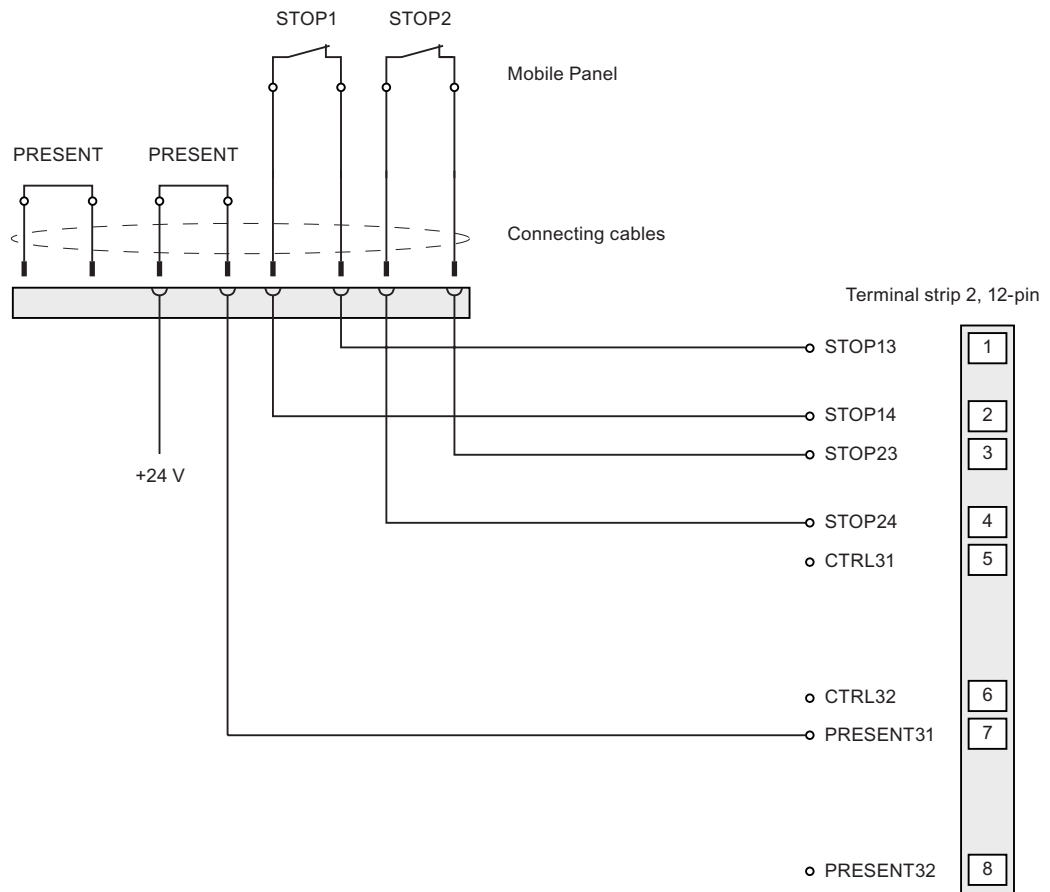

Power supply switched off

See also

Port assignment on the connection box DP (Page 272)

12.7 Wiring Examples for Enabling Switch and STOP Button

Introduction

This chapter contains connection examples for enable and STOP buttons corresponding to safety category 3 in accordance with EN 954-1.

Note

In order to guarantee safety category 3 in accordance with EN 954-1, please also consider the operating instructions of the monitoring device used.

Connection - Enabling button with evaluation device

The following figure shows the connection of an evaluating device to the enabling button of the mobile panel.

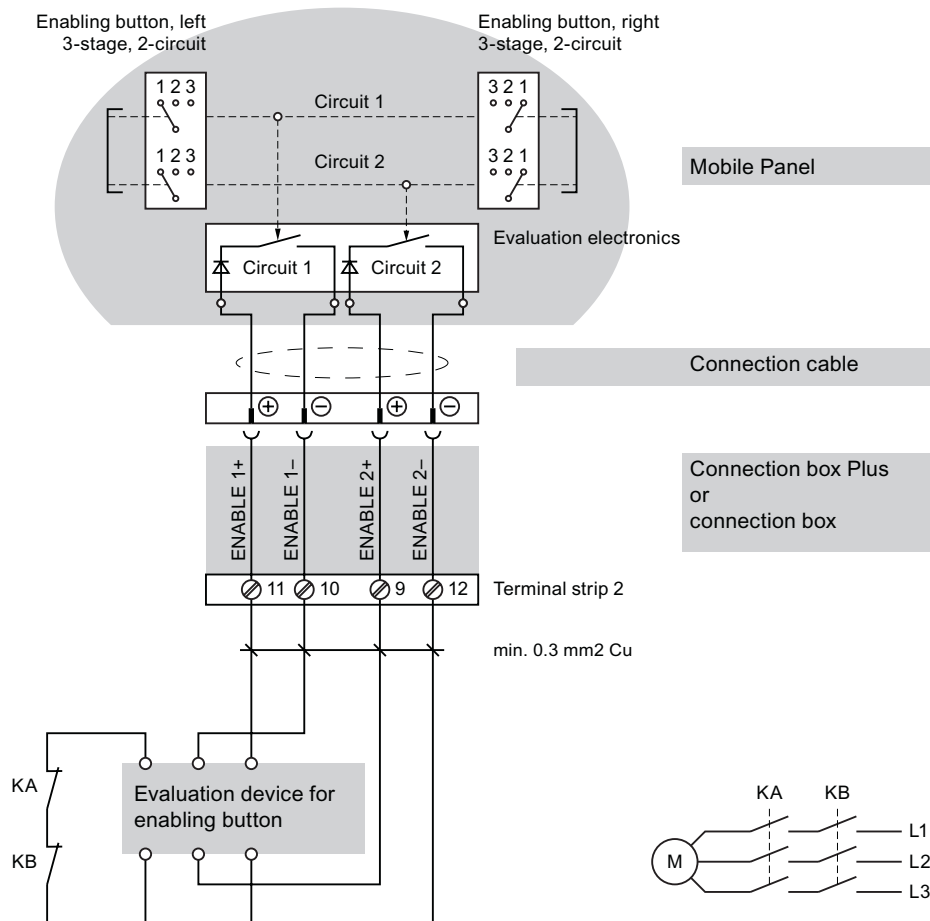

All contacts of the safety relay (contactor) KA and KB are fitted with positively-driven contacts in accordance with EN 50205.

Connection example 1 - Enabling button with safety circuit device

The following figure shows the connection of a SIRIUS 3TK2841 safety circuit device to the enabling button of the Mobile Panel.

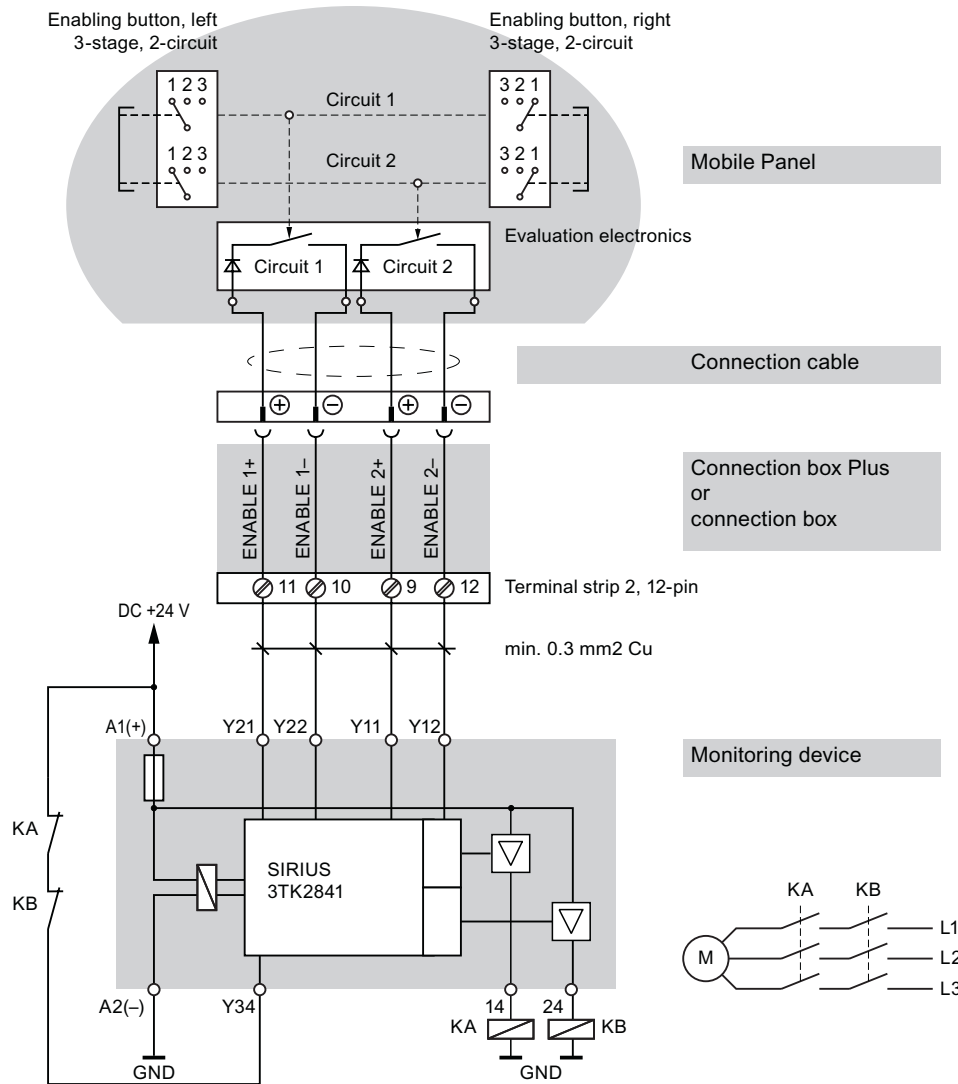

All contacts of the safety relay (contactor) KA and KB are fitted with positively-driven contacts in accordance with EN 50205.

Connection example 2 – STOP button with safety circuit device

The following figure shows the connection of a SIRIUS 3TK2822 or SIRIUS 3TK2841 to the STOP button of the Mobile Panel.

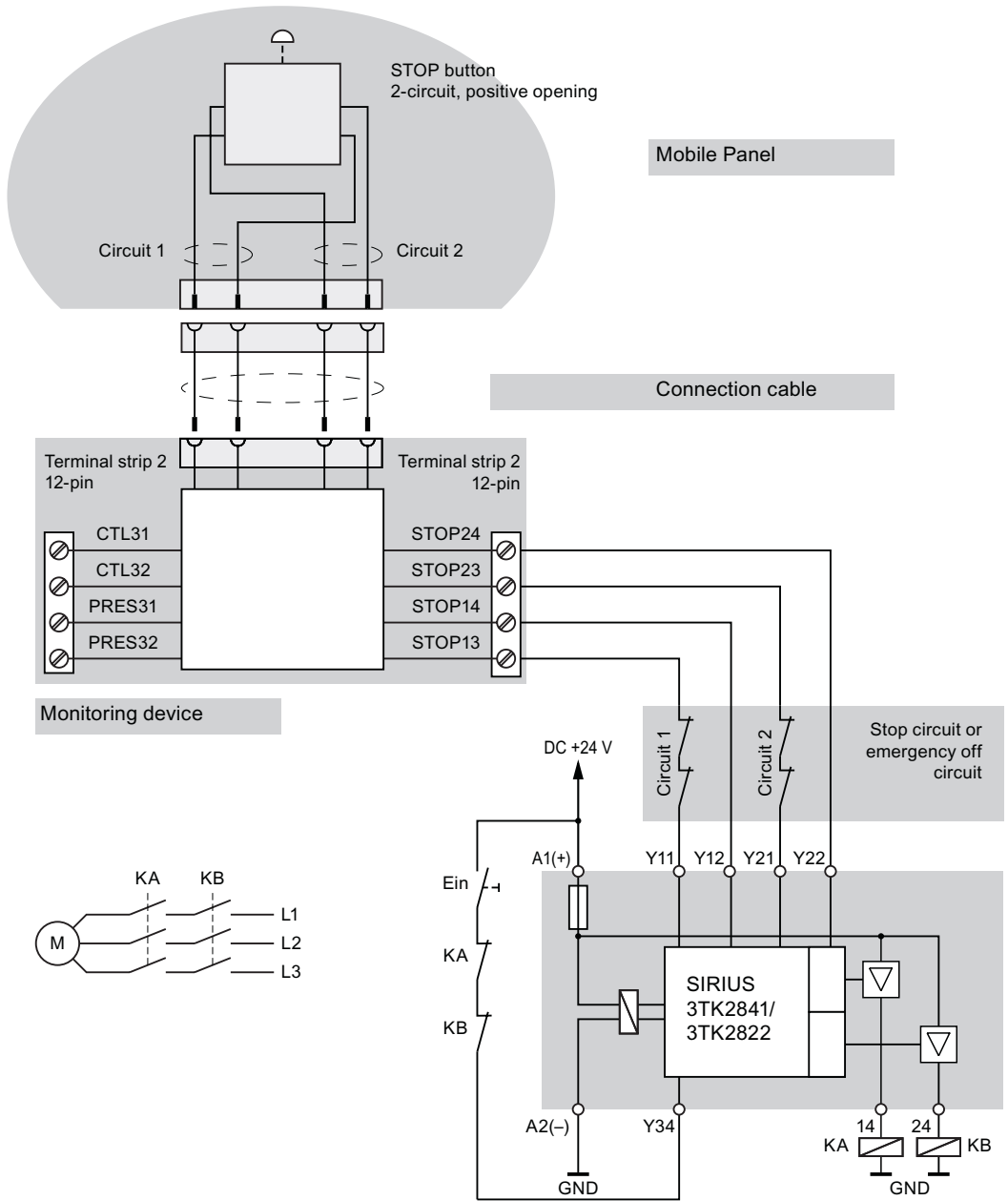

All contacts of the safety relay (contactor) KA and KB are fitted with positively-driven contacts in accordance with EN 50205.

Monitoring outputs may not be used for safety-related functions.

Appendix

A.1 ESD guideline

Definition of ESD

All electronic modules are equipped with large-scale integrated ICs or components. Due to their design, these electronic elements are highly sensitive to overvoltage, and thus to any electrostatic discharge. These electronic components are therefore specially identified as ESDs.

Abbreviations

The following abbreviation is commonly used for electrostatic sensitive devices:

- EGB – Elektrostatisch Gefährdete Bauteile/Baugruppen (Germany)
- ESD – Electrostatic Sensitive Device (internationally recognized term)

Labeling

ESDs are labeled with the following symbol:



Electrostatic charging

CAUTION**Electrostatic charging**

ESDs may be destroyed by voltages far below the level perceived by human beings. Voltages of this kind develop when a component or an assembly is touched by a person who is not grounded against static electricity. Usually, it is unlikely that damage to an ESD as a result of overvoltage is detected immediately but may become apparent only after a longer period of operation.

Prevent electrostatic charging of your body before you touch the ESD!

Anyone who is not connected to the electrical potential of their surroundings is subjected to electrostatic charging.

The following figure indicates the maximum electrostatic charge anyone is subjected to when coming into contact with the materials shown. These values correspond with specifications to IEC 801-2.

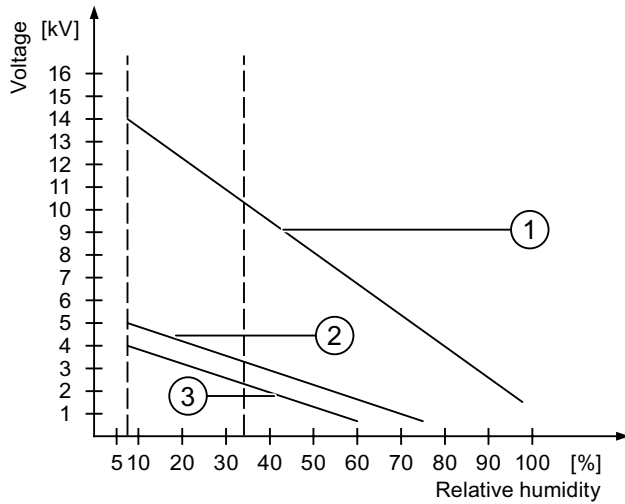

- ① Synthetic materials
- ② Wool
- ③ Antistatic materials such as wood or concrete

Protective measures against electrostatic discharge

<p>CAUTION</p> <p>Observe grounding measures</p> <p>When working with electrostatic sensitive devices, make sure that the person, the workplace and the packaging are properly grounded. This helps to avoid electrostatic charging.</p>
--

As a rule, only touch the ESD if this is unavoidable, for example for maintenance. When you touch modules, make sure that you do not touch the pins on the modules or the PCB tracks. In this way, the discharged energy cannot reach and damage the sensitive devices.

Discharge electrostatic electricity from your body if you are performing measurements on an ESD. Do so by touching grounded metallic parts.

Always use grounded measuring instruments.

A.2 System alarms

Introduction

System alarms on the HMI device provide information about internal states of the HMI device and PLC.

The following overview shows the causes of system alarms and how to eliminate the cause of error.

Some of the system alarms described in this section are relevant to individual HMI devices based on their range of features.

Note

System alarms are only indicated if an alarm window was configured. System alarms are output in the language currently set on your HMI device.

System alarm parameters

System alarms may contain encrypted parameters which are relevant to troubleshooting because they provide a reference to the source code of the runtime software. These parameters are output after the text "Error code:"

Meaning of the system alarms

All the system alarms that can be displayed are listed below. The system alarms are divided into different ranges:

10000 - Printer alarms

Number	Effect/cause	Remedy
10000	The print job could not be started or was canceled due to an unknown error. Faulty printer setup. Or: No authorization is available for accessing the network printer. Power supply failure during data transfer.	Check the printer settings, cable connections and the power supply. Set up the printer once again. Obtain a network printer authorization. If the error persists, contact the Hotline!
10001	No printer is installed or a default printer has not been set up.	Install a printer and/or select it as the default printer.
10002	Overflow of the graphics buffer for printing. Up to two images are buffered.	Allow sufficient intervals between successive print jobs.
10003	Images can now be buffered again.	--
10004	Overflow of the buffer for printing lines in text mode (e.g. alarms). Up to 1000 lines are buffered.	Allow sufficient intervals between successive print jobs.
10005	Text lines can now be buffered again.	--
10006	The Windows printing system reports an error. Refer to the output text and the error ID to determine the possible causes. Nothing is printed or the print is faulty.	Repeat the action if necessary.

20000 - Global script alarms

Number	Effect/causes	Remedy
20010	An error has occurred in the specified script line. Execution of the script was therefore aborted. Note the system alarm that may have occurred prior to this.	Select the specified script line in the configuration. Ensure that the tags used are of the allowed types. Check system functions for the correct number and types of parameters.
20011	An error has occurred in a script that was called by the specified script. Execution of the script was therefore aborted in the called script. Note the system alarm that may have occurred prior to this.	In the configuration, select the script that has been called directly or indirectly by the specified script. Ensure that the tags used are of the allowed types. Check system functions for the correct number and types of parameters.
20012	The configuration data is inconsistent. The script could therefore not be generated.	Recompile the configuration.
20013	The scripting component of WinCC flexible Runtime is not correctly installed. Therefore, no scripts can be executed.	Reinstall WinCC flexible Runtime on your PC. Rebuild your project with "Project > Generator > Generate" and transfer the project to the HMI device.
20014	The system function returns a value that is not written in any return tag.	Select the specified script in the configuration. Check whether the script name has been assigned a value.
20015	Too many successive scripts have been triggered in short intervals. When more than 20 scripts are queued for processing, any subsequent scripts are rejected. In this case, the script indicated in the alarm is not executed.	Find what is triggering the scripts. Extend the times, e.g. the polling time of the tags which trigger the scripts.

30000 - Alarms for IFwSetValue: SetValue()

Number	Effect/causes	Remedy
30010	The tag could not accept the function result, e.g. when it has exceeded the value range.	Check the tag type of the system function parameter.
30011	A system function could not be executed because the function was assigned an invalid value or type in the parameter.	Check the parameter value and tag type of the invalid parameter. If a tag is used as a parameter, check its value.
30012	A system function could not be executed because the function was assigned an invalid value or type in the parameter.	Check the parameter value and tag type of the invalid parameter. If a tag is used as a parameter, check its value.

40000 - Linear scaling alarms

Number	Effect/causes	Remedy
40010	The system function could not be executed since the parameters could not be converted to a common tag type.	Check the parameter types in the configuration.
40011	The system function could not be executed since the parameters could not be converted to a common tag type.	Check the parameter types in the configuration.

50000 - Data server alarms

Number	Effect/causes	Remedy
50000	The HMI device is receiving data faster than it is capable of processing. Therefore, no further data is accepted until all current data have been processed. Data exchange then resumes.	--
50001	Data exchange has been resumed.	--

60000 - Win32 function alarms

Number	Effect/causes	Remedy
60000	This alarm is generated by the "DisplaySystemAlarms" function. The text to be displayed is transferred to the function as a parameter.	--
60010	The file could not be copied in the direction defined because one of the two files is currently open or the source/target path is not available. It is possible that the Windows user has no access rights to one of the two files.	Restart the system function or check the paths of the source/target files. Using Windows NT/XP: The user executing WinCC flexible Runtime must be granted access rights for the files.
60011	An attempt was made to copy a file to itself. It is possible that the Windows user has no access rights to one of the two files.	Check the path of the source/target file. Using Windows NT/XP with NTFS: The user executing WinCC flexible Runtime must be granted access rights for the files.

70000 - Win32 function alarms

Number	Effect/causes	Remedy
70010	The application could not be started because it could not be found in the path specified or there is insufficient memory space.	Check whether the application exists in the specified path or close other applications.
70011	The system time could not be modified. The error alarm only appears in connection with area pointer "Date/time PLC". Possible causes: <ul style="list-style-type: none"> An invalid time was transferred in the job mailbox. The Windows user has no right to modify the system time. If the first parameter in the system alarm is displayed with the value 13, the second parameter indicates the byte containing the incorrect value.	Check the time which is to be set. Using Windows NT/XP: The user executing WinCC flexible Runtime must be granted the right to change the system time of the operating system.
70012	An error occurred when executing the function "StopRuntime" with the option "Runtime and operating system". Windows and WinCC flexible Runtime are not closed. One possible cause is that other programs cannot be closed.	Close all programs currently running. Then close Windows.
70013	The system time could not be modified because an invalid value was entered. Incorrect separators may have been used.	Check the time which is to be set.

Number	Effect/causes	Remedy
70014	The system time could not be modified. Possible causes: <ul style="list-style-type: none"> An invalid time was transferred. The Windows user has no right to modify the system time. Windows rejects the setting request.	Check the time which is to be set. Using Windows NT/XP: The user executing WinCC flexible Runtime must be granted the right to change the system time of the operating system.
70015	The system time could not be read because Windows rejects the reading function.	--
70016	An attempt was made to select a screen by means of a system function or job. This is not possible because the screen number specified does not exist. Or: A screen could not be generated due to insufficient system memory. Or: The screen is blocked. Or: Screen call has not been executed correctly.	Check the screen number in the function or job with the screen numbers configured. Assign the number to a screen if necessary. Check the details for the screen call and whether the screen is blocked for specific users.
70017	Date/time is not read from the area pointer because the address set in the PLC is either not available or has not been set up.	Change the address or set up the address in the PLC.
70018	Acknowledgment that the password list has been successfully imported.	--
70019	Acknowledgment that the password list has been successfully exported.	--
70020	Acknowledgment for activation of alarm reporting.	--
70021	Acknowledgment for deactivation of alarm reporting.	--
70022	Acknowledgment to starting the Import Password List action.	--
70023	Acknowledgment to starting the Export Password List action.	--
70024	The value range of the tag has been exceeded in the system function. The calculation of the system function is not performed.	Check the desired calculation and correct it if necessary.
70025	The value range of the tag has been exceeded in the system function. The calculation of the system function is not performed.	Check the desired calculation and correct it if necessary.
70026	No other screens are stored in the internal screen memory. No other screens can be selected.	--
70027	The backup of the RAM file system has been started.	--
70028	The files from the RAM have been copied in the Flash memory. The files from the RAM have been copied in the Flash memory. Following a restart, these saved files are copied back to the RAM file system.	--

Number	Effect/causes	Remedy
70029	Backup of the RAM file system has failed. No backup copy of the RAM file system has been made.	Check the settings in the "Control Panel > OP" dialog and save the RAM file system using the "Save Files" button in the "Persistent Storage" tab.
70030	The parameters configured for the system function are faulty. The connection to the new PLC was not established.	Compare the parameters configured for the system function with the parameters configured for the PLCs and correct them as necessary.
70031	The PLC configured in the system function is not an S7 PLC. The connection to the new PLC was not established.	Compare the S7 PLC name parameter configured for the system function with the parameters configured for the PLC and correct them as necessary.
70032	The object configured with this number in the tab order is not available in the selected screen. The screen changes but the focus is set to the first object.	Check the number of the tab order and correct it if necessary.
70033	An e-mail cannot be sent because a TCP/IP connection to the SMTP server no longer exists. This system alarm is generated only at the first attempt. All subsequent unsuccessful attempts to send an e-mail will no longer generate a system alarm. The event is regenerated when an e-mail has been successfully sent in the meantime. The central e-mail component in WinCC flexible Runtime attempts, in regular intervals (1 minute), to establish the connection to the SMTP server and to send the remaining e-mails.	Check the network connection to the SMTP server and re-establish it if necessary.
70034	Following a disruption, the TCP/IP connection to the SMTP server could be re-established. The queued e-mails are then sent.	--
70036	No SMTP server for sending e-mails is configured. An attempt to connect to an SMTP server has failed and it is not possible to send e-mails. WinCC flexible Runtime generates the system alarm after the first attempt to send an e-mail.	Configure an SMTP server: In WinCC flexible Engineering System using "Device settings > Device settings" In the Windows CE operating system using "Control Panel > Internet Settings > E-mail > SMTP Server"
70037	An e-mail cannot be sent for unknown reasons. The contents of the e-mail are lost.	Check the e-mail parameters (recipient etc.).
70038	The SMTP server has rejected sending or forwarding an e-mail because the domain of the recipient is unknown to the server or because the SMTP server requires authentication. The contents of the e-mail are lost.	Check the domain of the recipient address or disable the authentication on the SMTP server if possible. SMTP authentication is currently not used in WinCC flexible Runtime.
70039	The syntax of the e-mail address is incorrect or contains illegal characters. The contents of the e-mail are discarded.	Check the e-mail address of the recipient.
70040	The syntax of the e-mail address is incorrect or contains illegal characters.	--
70041	The import of the user management was aborted due to an error. Nothing was imported.	Check your user management or transfer it again to the panel.

Number	Effect/causes	Remedy
70042	The value range for the tags has been exceeded while executing the system function. The system function calculation has not been carried out.	Check the desired calculation and correct it if necessary.
70043	The value range for the tags has been exceeded while executing the system function. The system function calculation has not been carried out.	Check the desired calculation and correct it if necessary.

80000 - Archive alarms

Number	Effect/causes	Remedy
80001	The log specified is filled to the size defined (in percent) and must be stored elsewhere.	Store the file or table by executing a 'move' or 'copy' function.
80002	A line is missing in the specified log.	--
80003	The copying process for logging was not successful. In this case, it is advisable to check any subsequent system alarms, too.	--
80006	Since logging is not possible, this causes a permanent loss of the functionality.	In the case of databases, check whether the corresponding data source exists and start up the system again.
80009	A copying action has been completed successfully.	--
80010	Since the storage location was incorrectly entered in WinCC flexible, this causes a permanent loss of the functionality.	Configure the storage location for the respective log again and restart the system when the full functionality is required.
80012	Log entries are stored in a buffer. If the values are read to the buffer faster than they can be physically written (using a hard disk, for example), overloading may occur and recording is then stopped.	Archive fewer values. Or: Increase the logging cycle.
80013	The overload status no longer applies. Archiving resumes the recording of all values.	--
80014	The same action was triggered twice in quick succession. Since the process is already in operation, the action is only carried out once.	--
80015	This system alarm is used to report DOS or database errors to the user.	--
80016	The logs are separated by the system function "CloseAllLogs" and the incoming entries exceed the defined buffer size. All entries in the buffer are deleted.	Reconnect the logs.
80017	The number of incoming events cause a buffer overflow. This can be caused, for example, by several copying actions being activated at the same time. All copy jobs are deleted.	Stop the copy action.

Number	Effect/causes	Remedy
80019	The connection between WinCC flexible and all logs were closed, for example, after executing the system function "CloseAllLogs". Entries are written to the buffer and are then written to the logs when a connection is re-established. There is no connection to the storage location and the storage medium may be replaced, for example.	--
80020	The maximum number of simultaneously copy operations has been exceeded. Copying is not executed.	Wait until the current copying actions have been completed, then restart the last copy action.
80021	An attempt was made to delete a log which is still busy with a copy action. Deletion has not been executed.	Wait until the current copying actions have been completed, then restart the last action.
80022	An attempt was made to use the system function "StartSequenceLog" to start a sequence log for a log which is not configured as a sequence log. No sequence log file is created.	In the project, check <ul style="list-style-type: none"> • if the "StartSequenceLog" system function was properly configured. • if the tag parameters are properly provided with data on the HMI device.
80023	An attempt was made to copy a log to itself. The log is not copied.	In the project, check <ul style="list-style-type: none"> • if the "CopyLog" system function was properly configured. • if the tag parameters are properly provided with data on the HMI device.
80024	The "CopyLog" system function does not allow copying when the target log already contains data ("Mode" parameter). The log is not copied.	Edit the "CopyLog" system function in the project if necessary. Before you initiate the system function, delete the destination log file.
80025	You have canceled the copy operation. Data written up to this point are retained. The destination log file (if configured) is not deleted. The cancellation is reported by an error entry \$RT_ERR\$ at the end of the destination log.	--
80026	This alarm is output after all logs are initialized. Values are written to the logs from then on. Prior to this, no entries are written to the logs, irrespective whether WinCC flexible Runtime is active or not.	--
80027	The internal Flash memory has been specified as the storage location for a log. This is not permissible. No values are written to this log and the log file is not created.	Configure "Storage Card" or a network path as the storage location.
80028	The alarm returns a status report indicating that the logs are currently being initialized. No values are logged until the alarm 80026 is output.	--
80029	The number of logs specified in the alarm could not be initialized. The logs are initialized. The faulty log files are not available for logging jobs.	Evaluate the additional system alarms related to this alarm. Check the configuration, the ODBC (Open Database Connectivity) and the specified drive.
80030	The structure of the existing log file does not match the expected structure. Logging is stopped for this log.	Delete the existing log data manually, in advance.

Number	Effect/causes	Remedy
80031	The log in CSV format is corrupted. The log cannot be used.	Delete the faulty file.
80032	Logs can be assigned events. These are triggered as soon as the log is full. If WinCC flexible Runtime is started and the log is already full, the event is not triggered. The log specified no longer logs data because it is full.	Close WinCC flexible Runtime, delete the log, then restart WinCC flexible Runtime. Or: Configure a button which contains the same actions as the event and press it.
80033	"System Defined" is set in the data log file as the data source name. This causes an error. No data is written to the database logs, whereas the logging to the CSV logs works.	Reinstall SQL Sever 2005 Express.
80034	An error has occurred in the initialization of the logs. An attempt has been made to create the tables as a backup. This action was successful. A backup has been made of the tables of the corrupted log file and the cleared log was restarted.	No action is necessary. However, it is recommended to save the backup files or delete them in order to make the space available again.
80035	An error has occurred in the initialization of the logs. An attempt has been made to create backups of the tables and this has failed. No logging or backup has been performed.	It is recommended to save the backups or to delete them in order to release memory.
80044	The export of a log was interrupted because Runtime was closed or due to a power failure. It was detected that the export needed to be resume when Runtime restarted.	The export resumes automatically.
80045	The export of a log was interrupted due to an error in the connection to the server or at the server itself.	The export is repeated automatically. Check: <ul style="list-style-type: none"> • The connection to the server. • If the server is running. • If there is enough free space on the server.
80046	The destination file could not be written while exporting the log.	Check whether there is enough space on the server and if you have permission to create the log file.
80047	The log could not be read while exporting it.	Check whether the storage medium is correctly inserted.
80049	The log could not be renamed while preparing to export it. The job can not be completed."	Check whether the storage medium is correctly inserted and if there is sufficient space on the medium.
80050	The log which shall be exported is not closed. The job can not be completed.	Make sure the "CloseAll Logs" system function is called before using the "ExportLog" system function. Change the configuration as required.

90000 - FDA alarms

Number	Effect/causes	Remedy
90024	No operator actions can be logged due to lack of space on the storage medium for log. The operator action will therefore not be executed.	Make more space available by inserting an empty storage medium or swapping out the log files on the server using "ExportLog".
90025	No user actions can be logged because of error state of the archive. Therefore the user action will not be executed.	Check whether the storage medium is correctly inserted.

Number	Effect/causes	Remedy
90026	No operator actions can be logged because the log is closed. The operator action will therefore not be executed.	Before further operator actions are carried out, the log must be opened again using the system function "OpenAllLogs". Change the configuration as required.
90028	The password you entered is incorrect.	Enter the correct password.
90029	Runtime was closed during ongoing operation (perhaps due to a power failure) or a storage medium in use is incompatible with Audit Trail. An Audit Trail is not suitable if it belongs to another project or has already be archived.	Ensure that you are using the correct storage medium.
90030	Runtime was closed during ongoing operation (perhaps due to a power failure).	--
90031	Runtime was closed during ongoing operation (perhaps due to a power failure).	--
90032	Running out of space on the storage medium for log.	Make more space available by inserting an empty storage medium or swapping out the log files on the server using "ExportLog".
90033	No more space on the storage medium for log. As of now, no more operator actions requiring logging will be executed.	Make more space available by inserting an empty storage medium or swapping out the log files on the server using "ExportLog".
90039	You do not have the necessary authorization to perform this action.	Adapt or upgrade your authorizations.
90040	Audit Trail is switched off because of a forced user action.	Activate the "Audit Trail" again using the system function "StartLog".
90041	A user action which has to be logged has been executed without a logged on user.	A user action requiring logging should only be possible with permission. Change the configuration by setting a required permission for the input object.
90044	A user action which has to be confirmed was blocked, because there is another user action pending.	Repeat the user action if necessary.

110000 - Offline function alarms

Number	Effect/causes	Remedy
110000	The operating mode was changed. "Offline" mode is now set.	--
110001	The operating mode was changed. "Online" mode is now set.	--
110002	The operating mode was not changed.	Check the connection to the PLCs. Check whether the address area for the area pointer 88 "Coordination" in the PLC is available.
110003	The operating mode of the specified PLC was changed by the system function "SetConnectionMode". The operating mode is now "offline".	--
110004	The operating mode of the specified PLC has been changed by the system function "SetConnectionMode". The operating mode is now "online".	--

Number	Effect/causes	Remedy
110005	An attempt was made to use the system function SetConnectionMode to switch the specified PLC to "online" mode, although the entire system is in "offline" mode. This changeover is not allowed. The PLC remains in "offline" mode.	Switch the complete system to "online" mode, then execute the system function again.
110006	The content of the "project version" area pointer does not match the user version configured in WinCC flexible. WinCC flexible Runtime is therefore closed.	Check: <ul style="list-style-type: none"> • The project ID entered on the PLC. • The project ID entered in WinCC flexible.

120000 - Trend alarms

Number	Effect/causes	Remedy
120000	The trend is not displayed because you configured an incorrect axis to the trend or an incorrect trend.	Change the configuration.
120001	The trend is not displayed because you configured an incorrect axis to the trend or an incorrect trend.	Change the configuration.
120002	The trend is not displayed because the tag assigned attempts to access an invalid PLC address.	Check whether the data area for the tag exists in the PLC, the configured address is correct and the value range for the tag is correct.

130000 - System information alarms

Number	Effect/causes	Remedy
130000	The action was not executed.	Close all other programs. Delete files no longer required from the hard disk.
130001	The action was not executed.	Delete files no longer required from the hard disk.
130002	The action was not executed.	Close all other programs. Delete files no longer required from the hard disk.
130003	No data medium found. The operation is canceled.	Check, for example, if <ul style="list-style-type: none"> • The correct data medium is being accessed • The data medium is inserted
130004	The data medium is write-protected. The operation is canceled.	Check whether access has been made to the correct data carrier. Remove the write protection.
130005	The file is read only. The operation is canceled.	Check whether access has been made to the correct file. Edit the file attributes if necessary.
130006	Access to file failed. The operation is canceled.	Check, for example, if <ul style="list-style-type: none"> • The correct file is being accessed • The file exists • Another action is preventing simultaneous access to the file.
130007	The network connection is interrupted. Records cannot be saved or read over the network connection.	Check the network connection and eliminate the cause of error.
130008	The storage card is not available. Records cannot be saved to / read from the storage card.	Insert the storage card.

Number	Effect/causes	Remedy
130009	The specified folder does not exist on the storage card. Any files saved to this directory are not backed up when you switch off the HMI device.	Insert the storage card.
130010	The maximum nesting depth can be exhausted when, for example, a value change in a script results in the call of another script and the second script in turn has a value change that results in the call of yet a further script etc. The configured functionality is not supported.	Check the configuration.

140000 - Connection alarms chns7: Connection + device

Number	Effect/causes	Remedy
140000	An online connection to the PLC is established.	--
140001	The online connection to the PLC was shut down.	--
140003	No tag updating or writing is executed.	Check the connection and if the PLC is switched on. Check the parameter definitions in the Control Panel using "Set PG/PC interface". Restart the system.
140004	No tag update or write operations are executed because the access point or the module configuration is faulty.	Verify the connection and check whether the PLC is switched on. Check the access point or the module configuration (MPI, PPI, PROFIBUS) in the Control Panel with "Set PG/PC interface". Restart the system.
140005	No tag updating or writing is executed because the HMI device address is incorrect (possibly too high).	Use a different HMI device address. Verify the connection and check whether the PLC is switched on. Check the parameter definitions in the Control Panel using "Set PG/PC interface". Restart the system.
140006	No tag updating or writing is executed because the baud rate is incorrect.	Select a different baud rate in WinCC flexible (according to module, profile, communication peer, etc.).
140007	Tags are not updated or written because the bus profile is incorrect (see %1). The following parameters could not be written to the registry: 1: Tslot 2: Tqui 3: Tset 4: MinTsdr 5: MaxTsdr 6: Trdy 7: Tid1 8: Tid2 9: Gap Factor 10: Retry Limit	Check the user-defined bus profile. Check the connection and if the PLC is switched on. Check the parameter definitions in the Control Panel using "Set PG/PC interface". Restart the system.

Number	Effect/causes	Remedy
140008	No tag updating or writing is executed because baud rate is incorrect. The following parameters could not be written to the registry: 0: General error 1: Wrong version 2: Profile cannot be written to the registry. 3: The subnet type cannot be written to the registry. 4: The Target Rotation Time cannot be written to the registry. 5: Faulty Highest Address (HSA).	Check the connection and if the PLC is switched on. Check the parameter definitions in the Control Panel using "Set PG/PC interface". Restart the system.
140009	Tags are not updated or written because the module for S7 communication was not found.	Reinstall the module in the Control Panel using "Set PG/PC interface".
140010	No S7 communication partner found because the PLC is shut down. DP/T: The option "PG/PC is the only master" is not set in the Control Panel under "Set PG/PC interface."	Switch the PLC on. DP/T: If only one master is connected to the network, disable "PG/PC is the only master" in "Set PG/PC interface". If several masters are connected to the network, enable these. Do not change any settings, for this will cause bus errors.
140011	No tag updating or writing is executed because communication is down.	Check the connection and that the communication partner is switched on.
140012	There is an initialization problem (e.g. when WinCC flexible Runtime was closed in Task Manager). Or: Another application (e.g. STEP7) with different bus parameters is active and the driver cannot be started with the new bus parameters (transmission rate, for example).	Restart the HMI device. Or: Run WinCC flexible Runtime, then start your other applications.
140013	The MPI cable is disconnected and, thus, there is no power supply.	Check the connections.
140014	The configured bus address is in already in use by another application.	Edit the HMI device address in the PLC configuration.
140015	Wrong transmission rate Or: Faulty bus parameters (e.g. HSA) Or: OP address > HSA or: Wrong interrupt vector (interrupt does not arrive at the driver)	Correct the relevant parameters.
140016	The hardware does not support the configured interrupt.	Change the interrupt number.
140017	The set interrupt is in use by another driver.	Change the interrupt number.
140018	The consistency check was disabled by SIMOTION Scout. Only a corresponding note appears.	Enable the consistency check with SIMOTION Scout and once again download the project to the PLC.
140019	SIMOTION Scout is downloading a new project to the PLC. Connection to the PLC is canceled.	Wait until the end of the reconfiguration.
140020	The version in the PLC and that of the project (FWX file) do not match. Connection to the PLC is canceled.	The following remedies are available: Download the current version to the PLC using SIMOTION Scout. Regenerate the project using WinCC flexible ES, close WinCC flexible Runtime and restart with a new configuration.

150000 - Connection alarms chnAS511: Connection

Number	Effect/causes	Remedy
150000	No more data is read or written. Possible causes: <ul style="list-style-type: none"> • The cable is defective. • The PLC does not respond, is defective, etc. • The wrong port is used for the connection. • System overload 	Ensure that the cable is plugged in, the PLC is operational, the correct port is being used. Restart the system if the system alarm persists.
150001	Connection is up because the cause of the interruption has been eliminated.	--

160000 - Connection alarms IVar (WinLC) / OPC: Connection

Number	Effect/causes	Remedy
160000	No more data is read or written. Possible causes: <ul style="list-style-type: none"> • The cable is defective. • The PLC does not respond, is defective, etc. • The wrong port is used for the connection. • System overload 	Ensure that the cable is plugged in, the PLC is operational, the correct port is being used. Restart the system if the system alarm persists.
160001	Connection is up because the cause of the interruption has been eliminated.	--
160010	No connection to the server because the server identification (CLS-ID) cannot be determined. Values cannot be read or written.	Check access rights.
160011	No connection to the server because the server identification (CLS-ID) cannot be determined. Values cannot be read or written.	Check, for example, if <ul style="list-style-type: none"> • The server name is correct. • The computer name is correct. • The server is registered.
160012	No connection to the server because the server identification (CLS-ID) cannot be determined. Values cannot be read or written.	Check, for example, if <ul style="list-style-type: none"> • The server name is correct. • The computer name is correct. • The server is registered. Note for advanced users: Interpret the value from HRESULT.
160013	The specified server was started as InProc server. This has not been released and may possibly lead to incorrect behavior because the server is running in the same process area as the WinCC flexible Runtime software.	Configure the server as OutProc Server or Local Server.
160014	Only one OPC server project can be started on a PC/MP. An alarm is output when an attempt is made to start a second project. The second project has no OPC server functionality and cannot be located as an OPC server by external sources.	Do not start a second project with OPC server functionality on the computer.

170000 - S7 dialog alarms

Number	Effect/causes	Remedy
170000	S7 diagnostics events are not indicated because it is not possible to log on to the S7 diagnostics functions at this device. The service is not supported.	--
170001	The S7 diagnostics buffer cannot be viewed because communication with the PLC is shut down.	Set the PLC to online mode.
170002	The S7 diagnostics buffer cannot be viewed because reading of the diagnostics buffer (SSL) was canceled with error.	--
170003	An S7 diagnostics event cannot be visualized. The system returns internal error %2.	--
170004	An S7 diagnostics event cannot be visualized. The system returns an internal error of error class %2, error number %3.	--
170007	It is not possible to read the S7 diagnostics buffer (SSL) because this operation was canceled with an internal error of class %2 and error code %3.	--

180000 - Misc/common alarms

Number	Effect/causes	Remedy
180000	A component/OCX received configuration data with a version ID which is not supported.	Install a newer component.
180001	System overload because too many actions running in parallel. Not all the actions can be executed, some are rejected.	Several remedies are available: <ul style="list-style-type: none"> • Generate the alarms at a slower rate (polling). • Initiate scripts and functions at greater intervals. If the alarm appears more frequently: Restart the HMI device.
180002	The screen keyboard could not be activated. Possible causes: "TouchInputPC.exe" was not registered due to a faulty Setup.	Reinstall WinCC flexible Runtime.

190000 - Tag alarms

Number	Effect/causes	Remedy
190000	It is possible that the tag is not updated.	--
190001	The tag is updated after the cause of the last error state has been eliminated (return to normal operation).	--
190002	The tag is not updated because communication with the PLC is down.	Select the system function "SetOnline" to go online.
190004	The tag is not updated because the configured tag address does not exist.	Check the configuration.
190005	The tag is not updated because the configured PLC type does not exist for this tag.	Check the configuration.

Number	Effect/causes	Remedy
190006	The tag is not updated because it is not possible to map the PLC type in the data type of the tag.	Check the configuration.
190007	The tag value is not modified because the connection to the PLC is interrupted or the tag is offline.	Set online mode or reconnect to the PLC.
190008	The threshold values configured for the tag have been violated, for example, by <ul style="list-style-type: none"> • A value entered • A system function • A script 	Observe the configured or current threshold values of the tag.
190009	An attempt has been made to assign the tag a value which is outside the permitted range of values for this data type. For example, a value of 260 was entered for a byte tag or a value of -3 for an unsigned word tag.	Observe the range of values for the data type of the tags.
190010	Too many values are written to the tag (for example, in a loop triggered by a script). Values are lost because only up to 100 actions are saved to the buffer.	The following remedies are available: <ul style="list-style-type: none"> • Increase the time interval between multiple write actions. • Do not use an array tag longer than 6 words when you configure an acknowledgment on the HMI device using "Acknowledgment HMI".
190011	Possible cause 1: The value entered could not be written to the configured PLC tag because the high or low limit was exceeded. The system discards the entry and restores the original value. Possible cause 2: The connection to the PLC was interrupted.	Make sure that the value entered lies within the range of values of the control tags. Check the connection to the PLC.
190012	It is not possible to convert a value from a source format to a target format, for example: An attempt is being made to assign a value to a counter that is outside the valid, PLC-specific value range. A tag of the type Integer should be assigned a value of the type String.	Check the range of values or the data type of the tags.
190013	The user has entered a string that is longer than the tag. The string is automatically shortened to the permitted length.	Only enter strings that do not exceed the permitted tag length.

190100 - Area pointer alarms

Number	Effect/causes	Remedy
190100	The area pointer is not updated because the address configured for this pointer does not exist. Type 1 Warnings 2 Errors 3 PLC acknowledgment 4 HMI device acknowledgment 5 LED mapping 6 Trend request 7 Trend transfer 1 8 Trend transfer 2 No.: Consecutive number displayed in WinCC flexible ES.	Check the configuration.
190101	The area pointer is not updated because it is not possible to map the PLC type to the area pointer type. Parameter type and no.: see alarm 190100	--
190102	The area pointer is updated after the cause of the last error state has been eliminated (return to normal operation). Parameter type and no.: See alarm 190100.	--

200000 - PLC coordination alarms

Number	Effect/causes	Remedy
200000	Coordination is not executed because the address configured in the PLC does not exist/is not set.	Change the address or set up the address in the PLC.
200001	Coordination is canceled because the write access to the address configured in the PLC is not possible.	Change the address or set the address in the PLC at an area which allows write access.
200002	Coordination is not carried out at the moment because the address format of the area pointer does not match the internal storage format.	Internal error
200003	Coordination can be executed again because the last error state is eliminated (return to normal operation).	--
200004	The coordination may not be executed.	--
200005	No more data is read or written. Possible causes: <ul style="list-style-type: none"> • The cable is defective. • The PLC does not respond, is defective, etc. • System overload 	Ensure that the cable is plugged in and the PLC is operational. Restart the system if the system alarm persists.

200100 - PLC user version alarms

Number	Effect/causes	Remedy
200100	Coordination is not executed because the address configured in the PLC does not exist/is not set.	Change the address or set up the address in the PLC.

Number	Effect/causes	Remedy
200101	Coordination is canceled because the write access to the address configured in the PLC is not possible.	Change the address or set the address in the PLC at an area which allows write access.
200102	Coordination is not carried out at the moment because the address format of the area pointer does not match the internal storage format.	Internal error
200103	Coordination can be executed again because the last error state is eliminated (return to normal operation).	--
200104	The coordination may not be executed.	--
200105	No more data is read or written. Possible causes: <ul style="list-style-type: none"> • The cable is defective. • The PLC does not respond, is defective, etc. • System overload 	Ensure that the cable is plugged in and the PLC is operational. Restart the system if the system alarm persists.

210000 - PLC job alarms

Number	Effect/causes	Remedy
210000	Jobs are not processed because the address configured in the PLC does not exist/has not been set up.	Change the address or set up the address in the PLC.
210001	Jobs are not processed because read/write access to the address configured in the PLC is not possible.	Change the address or set up the address in the PLC in an area which allows read/write access.
210002	Jobs are not executed because the address format of the area pointer does not match the internal storage format.	Internal error
210003	The job buffer is processed again because the last error status has been eliminated (return to normal operation).	--
210004	It is possible that the job buffer will not be processed.	--
210005	A control request with an illegal number was initiated.	Check the PLC program.
210006	An error occurred while attempting to execute the control request. As a result, the control request is not executed. Observe the next/previous system alarms.	Check the parameters of the control request. Recompile the configuration.

220000 - WinCC channel adapter alarms

Number	Effect/causes	Remedy
220001	The tag is not downloaded because the associated communication driver / HMI device does not support the download of Boolean/discrete data types.	Change the configuration.
220002	The tag is not downloaded because the associated communication driver / HMI device does not support write access to the data type BYTE.	Change the configuration.

Number	Effect/causes	Remedy
220003	The communication driver cannot be loaded. The driver may not be installed.	Install the driver by reinstalling WinCC flexible Runtime.
220004	Communication is down and no update data is transferred because the cable is not connected or defective etc.	Check the connection.
220005	Communication is up.	--
220006	The connection between the specified PLC and the specified port is active.	--
220007	The connection to the specified PLC is interrupted at the specified port.	Check whether <ul style="list-style-type: none"> • The cable is plugged in • The PLC is OK • The correct port is used • Your configuration is OK (port parameters, protocol settings, PLC address). Restart the system if the system alarm persists.
220008	The communication driver cannot access or open the specified port. The port may be in use by another application or the port used is not available on the destination device. There is no communication with the PLC.	Close all the applications which access this port and restart the computer. Use another port of the system.

230000 - View alarms

Number	Effect/causes	Remedy
230000	The value entered could not be accepted. The system discards the entry and restores the previous value. Either <ul style="list-style-type: none"> • The value range has been exceeded • Illegal characters have been entered • The maximum permitted number of users has been exceeded. 	Enter a practical value or delete any unneeded users.
230002	The currently logged in user has not the required authorization. The system therefore discards the input and restored the previous value.	Log on as a user with appropriate authorization.
230003	Changeover to the specified screen failed because the screen is not available/configured. The current screen remains selected.	Configure the screen and check the screen selection function.
230005	The value range of the tag has been exceeded in the I/O field. The original value of the tag is retained.	Observe the range of values for the tag when entering a value.
230100	During navigation in the web browser, the system returned a message which may be of interest to the user. The web browser continues to run but may not (fully) show the new page.	Navigate to another page.
230200	The connection to the HTTP channel was interrupted due to an error. This error is explained in detail by another system alarm. Data is no longer exchanged.	Check the network connection. Check the server configuration.

Number	Effect/causes	Remedy
230201	The connection to HTTP channel was established. Data is exchanged.	--
230202	WININET.DLL has detected an error. This error is usually generated if it is not possible to connect to the server or if the server denies access because the client could not authenticate itself. A rejected server certificate could also cause a communication error in secure SSL connections. For details, refer to the error text in the alarm. This text is always output in the language of your Windows installation, as it is returned by the Windows operating system. Process values are not exchanged. The part of the alarm which is returned by the Windows operating system may not be displayed, for example "An error has occurred." WININET.DLL returns the following error: Number: 12055 Text:HTTP: <no error text available>."	Depending on the cause: When an attempt to connect fails or a timeout error occurs: <ul style="list-style-type: none"> • Check the network connection and the network. • Check the server address. • Check whether the WebServer is actually running on the destination station. Faulty authorization: <ul style="list-style-type: none"> • The configured user name and/or password do not match those on the server. Establish consistency When the server certificate is rejected: Certificate signed by an unknown CA (): <ul style="list-style-type: none"> • Either ignore this item in your project, or • Install a certificate that has been signed with a root certificate known to the client computer. The date of the certificate is invalid: <ul style="list-style-type: none"> • Either ignore this item in your project, or • Install a certificate with a valid date on the server. Invalid CN (Common Name or Computer Name): <ul style="list-style-type: none"> • Either ignore this item in your project, or • Install a certificate with a name that corresponds to that of the server address.
230203	Although a connection can be made to the server, the HTTP server refuses to connect because <ul style="list-style-type: none"> • WinCC flexible Runtime is not running on the server, or • The HTTP channel is not supported (503 Service unavailable). Other errors can only occur if the Webserver does not support the HTTP channel. The language of the alarm text depends on the Webserver. Data is not exchanged.	Error 503 Service unavailable: Check that WinCC flexible Runtime is running on the server and the HTTP channel is supported.
230301	An internal error has occurred. An English text explains the error in more detail. This may be caused by insufficient memory. OCX does not work.	--
230302	The name of the remote server cannot be resolved. The attempt to connect failed.	Check the configured server address. Check whether the DNS service is available on the network.
230303	The remote server is not running on the addressed computer. Wrong server address. The attempt to connect failed.	Check the configured server address. Check whether the remote server is running on the target computer.
230304	The remote server on the addressed computer is incompatible with VNCOCX. The attempt to connect failed.	Use a compatible remote server.

Number	Effect/causes	Remedy
230305	The authentication has failed because the password is incorrect. The attempt to connect failed.	Configure the correct password.
230306	Error in the connection to the remote server. This may occur as a result of network problems. The attempt to connect failed.	Check whether <ul style="list-style-type: none"> • The bus cable is plugged in • There are network problems.
230307	The connection to the remote server was shut down because <ul style="list-style-type: none"> • The remote server was shut down, or • The user instructed the server to close all connections. The connection is closed.	--
230308	This alarm provides information on the connection status. An attempt is made to connect.	--

240000 - Authorization alarms

Number	Effect/causes	Remedy
240000	WinCC flexible Runtime is operating in demo mode. You have no authorization or your authorization is corrupted.	Install the authorization.
240001	WinCC flexible Runtime is operating in demo mode. Too many tags are configured for the installed version.	Load an adequate authorization / powerpack.
240002	WinCC flexible Runtime is operating with a time-limited emergency authorization.	Restore the full authorization.
240004	Error while reading the emergency authorization. WinCC flexible Runtime is operating in demo mode.	Restart WinCC flexible Runtime, install the authorization or repair the authorization (see Commissioning Instructions Software Protection).
240005	The Automation License Manager has detected an internal system fault. Possible causes: <ul style="list-style-type: none"> • A corrupt file • A defective installation • No free space for the Automation License Manager etc. 	Reboot the HMI device or PC. If this does not solve the problem, remove the Automation License Manager and install it again.

250000 - S7 Force alarms

Number	Effect/causes	Remedy
250000	The tag in the specified line in "Status Force" is not updated because the address configured for this tag is not available.	Check the set address and then verify that the address is set up in the PLC.
250001	The tag in the specified line in "Status Force" is not updated because the PLC type configured for this tag does not exist.	Check the set address.

Number	Effect/causes	Remedy
250002	The tag in the specified line in "Status Force" is not updated because it is not possible to map the PLC type in the tag type.	Check the set address.
250003	An attempt to connect to the PLC failed. The tags are not updated.	Check the connection to the PLC. Check that the PLC is switched on and is online.

260000 - Password system alarms

Number	Effect/causes	Remedy
260000	An unknown user or an unknown password has been entered in the system. The current user is logged off from the system.	Log on to the system as a user with a valid password.
260001	The logged in user does not have sufficient authorization to execute the protected functions on the system.	Log on to the system as a user with sufficient authorization.
260002	This alarm is triggered by the system function "TrackUserChange".	--
260003	The user has logged off from the system.	--
260004	The user name entered into the user view already exists in the user management.	Select another user name because user names have to be unique in the user management.
260005	The entry is discarded.	Enter a shorter user name.
260006	The entry is discarded.	Use a shorter or longer password.
260007	The logon timeout value entered is outside the valid range of 0 to 60 minutes. The new value is discarded and the original value is retained.	Enter a logon timeout value between 0 and 60 minutes.
260008	An attempt was made to read a PTPProRun.pwl file created with ProTool V 6.0 in WinCC flexible. Reading the file was canceled due to incompatibility of the format.	--
260009	You have attempted to delete the user "Admin" or "PLC User". These users are fixed components of the user management and cannot be deleted.	If you need to delete a user, because perhaps you have exceeded the maximum number permitted, delete another user.
260012	The passwords entered in the "Change Password" dialog and the confirmation field are not identical. The password has not been changed. User will be logged off.	You have to log on to the system again. Then enter the identical password twice to be able to change the password.
260013	The password entered in the "Change Password" dialog is invalid because it is already in use. The password has not been changed. User will be logged off.	You have to log on to the system again. Then enter a new password that has not been used before.
260014	You have tried unsuccessfully to log on three times in succession. You will be locked out and assigned to group no. 0.	You can log on to the system with your correct password. Only an administrator can change the assignment to a group.
260023	The password you entered does not meet the necessary security guidelines.	Enter a password that contains at least one number.
260024	The password you entered does not meet the necessary security guidelines.	Enter a password that contains at least one character.

Number	Effect/causes	Remedy
260025	The password you entered does not meet the necessary security guidelines.	Enter a password that contains at least one special character.
260028	Upon system start-up, an attempt to log on, or when trying to change the password of a SIMATIC log-on user, the system attempts to access the SIMATIC Logon Server. If attempting to log on, the new user is not logged in. If a different user was logged on before, then this user is logged off.	Check the connection to the SIMATIC Logon Server and its configuration; for example: 1. Port number 2. IP address 3. Server name 4. Functional transfer cable Or use a local user.
260029	The SIMATIC Logon user is not associated to any or several groups. The new user is not logged in. If a different user was logged on before, then this user is logged off.	Check the user data on the SIMATIC Logon Server and the configuration in your WinCC flexible project. A user may only be assigned to one group.
260030	The SIMATIC Logon user could not change his password on the SIMATIC Logon Server. The new password may not comply with the password regulations on the server or the user does not have the right to change his password. The old password remains and the user is logged off.	Log in again and choose a different password. Check the password rules on the SIMATIC Logon Server.
260031	It was not possible to log the user on to the SIMATIC Logon Server. The user name or the password could be incorrect or the user does not have sufficient rights to log on. The new user is not logged in. If a different user was logged on before, then this user is logged off.	Try again. If necessary, check the password data on the SIMATIC Logon Server.
260032	It was not possible to log the user on to the SIMATIC Logon Server as his account is blocked. The new user is not logged in. If a different user was logged on before, then this user is logged off.	Check the user data on the SIMATIC Logon Server.
260033	The action change password or log on user could not be carried out.	Check the connection to the SIMATIC Logon Server and its configuration; for example: 1. Port number 2. IP address 3. Server name 4. Functional transfer cable Or use a local user.
260034	The last logon operation has not yet ended. A user action or a logon dialog can therefore not be called. The logon dialog is not opened. The user action is not executed.	Wait until the logon operation is complete.
260035	The last attempt to change the password was not completed. A user action or a logon dialog can therefore not be called. The logon dialog is not opened. The user action is not executed.	Wait until the procedure is complete.
260036	There are insufficient licenses on the SIMATIC Logon Sever. The logon is not authorized.	Check the licensing on the SIMATIC Logon Server.

Number	Effect/causes	Remedy
260037	There is no license on the SIMATIC Logon Sever. A logon is not possible. It is not possible to log on via the SIMATIC Logon Server, only via a local user.	Check the licensing on the SIMATIC Logon Server.
260040	The system attempts to access the SIMATIC Logon Server upon system start-up or when trying to change the password. If attempting to log on, the new user is not logged in. If a different user was logged on before, then this user is logged off.	Check connection to the domain and its configuration in the Runtime security settings editor. Or use a local user.

270000 - System alarms

Number	Effect/causes	Remedy
270000	A tag is not indicated in the alarm because it attempts to access an invalid address in the PLC.	Check whether the data area for the tag exists in the PLC, the configured address is correct and the value range for the tag is correct.
270001	There is a device-specific limit as to how many alarms may be queued for output (see the operating instructions). This limit has been exceeded. The view no longer contains all the alarms. However, all alarms are written to the alarm buffer.	--
270002	The view shows alarms of a log for which there is no data in the current project. Wildcards are output for the alarms.	Delete older log data if necessary.
270003	The service cannot be set up because too many devices want to use this service. A maximum of four devices may execute this action.	Reduce the number of HMI devices which want to use the service.
270004	Access to persistent buffer is not possible. Alarms cannot be restored or saved.	If the problems persist at the next startup, contact Customer Support (delete Flash).
270005	Persistent buffer damaged: Alarms cannot be restored.	If the problems persist at the next startup, contact Customer Support (delete Flash).
270006	Project modified: Alarms cannot be restored from the persistent buffer.	The project was generated and transferred new to the HMI device; The error should no longer occur when the device starts again.
270007	A configuration problem is preventing the restore (a DLL is missing, a directory is unknown, etc.).	Update the operating system and then transfer your project again to the HMI device.

280000 - DPHMI alarms Connection

Number	Effect/causes	Remedy
280000	Connection is up because the cause of the interruption has been eliminated.	--
280001	No more data is read or written. Possible causes: <ul style="list-style-type: none"> • The cable is defective • The PLC does not respond, is defective, etc. • The wrong port is used for the connection • System overload 	Check whether <ul style="list-style-type: none"> • The cable is plugged in • The PLC is OK • The correct port is used. Restart the system if the system alarm persists.

Number	Effect/causes	Remedy
280002	The connection used requires a function block in the PLC. The function block has responded. Communication is now enabled.	--
280003	The connection used requires a function block in the PLC. The function block has not responded.	Check whether <ul style="list-style-type: none"> • The cable is plugged in • The PLC is OK • The correct port is used. Restart the system if the system alarm persists. Remedy depends on the error code: 1: The function block must set the COM bit in the response container. 2: The function block must not set the ERROR bit in the response container. 3: The function block must respond within the specified time (timeout). 4: Go online to the PLC.
280004	The connection to the PLC is interrupted. There is no data exchange at present.	Check the connection parameters in WinCC flexible. Ensure that the cable is plugged in, the PLC is operational, the correct port is being used. Restart the system if the system alarm persists.

290000 - Recipe system alarms

Number	Effect/causes	Remedy
290000	The recipe tag could not be read or written. It is assigned the start value. The alarm can be entered in the alarm buffer for up to four more failed tags if necessary. After that, alarm 290003 is output.	Check in the configuration that the address has been set up in the PLC.
290001	An attempt has been made to assign a value to a recipe tag which is outside the value range permitted for this type. The alarm can be entered in the alarm buffer for up to four more failed tags if necessary. After that, alarm 290004 is output.	Observe the value range for the tag type.
290002	It is not possible to convert a value from a source format to a target format. The alarm can be entered in the alarm buffer for up to four more failed recipe tags if necessary. After that, alarm 290005 is output.	Check the value range or type of the tag.
290003	This alarm is output when alarm number 290000 is triggered more than five times. In this case, no further separate alarms are generated.	Check in the configuration that the tag addresses have been set up in the PLC.
290004	This alarm is output when alarm number 290001 is triggered more than five times. In this case, no further separate alarms are generated.	Observe the value range for the tag type.

Number	Effect/causes	Remedy
290005	This alarm is output when alarm number 290002 is triggered more than five times. In this case, no further separate alarms are generated.	Check the value range or type of the tag.
290006	The threshold values configured for the tag have been violated by values entered.	Observe the configured or current threshold values of the tag.
290007	There is a difference between the source and target structure of the recipe currently being processed. The target structure contains an additional data recipe tag which is not available in the source structure. The data recipe tag specified is assigned its start value.	Insert the specified data recipe tag in the source structure.
290008	There is a difference between the source and target structure of the recipe currently being processed. The source structure contains an additional data recipe tag which is not available in the target structure and therefore cannot be assigned. The value is rejected.	Remove the specified data recipe tag in the specified recipe from the project.
290010	The storage location configured for the recipe is not permitted. Possible causes: Illegal characters, write protection, data carrier out of space or does not exist.	Check the configured storage location.
290011	The record with the specified number does not exist.	Check the source for the number (constant or tag value).
290012	The recipe with the specified number does not exist.	Check the source for the number (constant or tag value).
290013	An attempt was made to save a record under a record number which already exists. The action is not executed.	The following remedies are available: <ul style="list-style-type: none"> • Check the source for the number (constant or tag value). • First, delete the record. • Change the "Overwrite" function parameter.
290014	The file specified to be imported could not be found.	Check: <ul style="list-style-type: none"> • The file name • Ensure that the file is in the specified directory.
290020	Alarm reporting that the download of records from the HMI device to the PLC has started.	--
290021	Alarm reporting that the download of records from the HMI device to the PLC was completed.	--
290022	Alarm reporting that the download of records from the HMI device to the PLC was canceled due to an error.	Check in the configuration whether: <ul style="list-style-type: none"> • The tag addresses are configured in the PLC • The recipe number exists • The record number exist • The "Overwrite" function parameter is set
290023	Alarm reporting that the download of records from the PLC to the HMI device has started.	--

Number	Effect/causes	Remedy
290024	Alarm reporting that the download of records from the PLC to the HMI device was completed.	---
290025	Alarm reporting that the download of records from the PLC to the HMI device was canceled due to an error.	Check in the configuration whether: <ul style="list-style-type: none"> • The tag addresses are configured in the PLC • The recipe number exists • The record number exist • The "Overwrite" function parameter is set
290026	An attempt has been made to read/write a record although the record is not free at present. This error may occur in the case of recipes for which downloading with synchronization has been configured.	Set the record status to zero.
290027	Unable to connect to the PLC at present. As a result, the record can neither be read nor written. Possible causes: No physical connection to the PLC (no cable plugged in, cable is defect) or the PLC is switched off.	Check the connection to the PLC.
290030	This alarm is output after you selected screen which contains a recipe view in which a record is already selected.	Reload the record from the storage location or retain the current values.
290031	While saving, it was detected that a record with the specified number already exists.	Overwrite the record or cancel the action.
290032	While exporting records it was detected that a file with the specified name already exists.	Overwrite the file or cancel the process.
290033	Confirmation request before deleting records.	--
290040	A record error with error code %1 that cannot be described in more detail occurred. The action is canceled. It is possible that the record was not installed correctly on the PLC.	Check the storage location, the record, the "Data record" area pointer and if necessary, the connection to the PLC. Restart the action after a short time. If the error persists, contact Customer Support. Forward the relevant error code to Customer Support.
290041	A record or file cannot be saved because the storage location is full.	Delete files no longer required.
290042	An attempt was made to execute several recipe actions simultaneously. The last action was not executed.	Trigger the action again after waiting a short period.
290043	Confirmation request before storing records.	--
290044	The data store for the recipe has been destroyed and is deleted.	--
290050	Alarm reporting that the export of records has started.	--
290051	Alarm reporting that the export of records was completed.	--
290052	Alarm reporting that the export of records was canceled due to an error.	Ensure that the structure of the records at the storage location and the current recipe structure on the HMI device are identical.
290053	Alarm reporting that the import of records has started.	--

Number	Effect/causes	Remedy
290054	Alarm reporting that the import of records was completed.	--
290055	Alarm reporting that the import of records was canceled due to an error.	Ensure that the structure of the records at the storage location and the current recipe structure on the HMI device are identical.
290056	Error when reading/writing the value in the specified line/column. The action was canceled.	Check the specified line/column.
290057	The tags of the recipe specified were toggled from "offline" to "online" mode. Each change of a tag in this recipe is now immediately downloaded to the PLC.	--
290058	The tags of the specified recipe were toggled from "offline" to "online" mode. Modifications to tags in this recipe are no longer immediately transferred to the PLC but must be transferred there explicitly by downloading a record.	--
290059	Alarm reporting that the specified record was saved.	--
290060	Alarm reporting that the specified record memory was cleared.	--
290061	Alarm reporting that clearing of record memory was canceled due to an error.	--
290062	The record number is above the maximum of 65536. This record cannot be created.	Select another number.
290063	This occurs with the system function "ExportDataRecords" when the parameter "Overwrite" is set to No. An attempt has been made to save a recipe under a file name which already exists. The export is canceled.	Check the "ExportDataRecords" system function.
290064	Alarm reporting that the deletion of records has started.	--
290065	Alarm reporting that the deletion of records has successfully completed.	--
290066	Confirmation request before deleting records.	--
290068	Security request to confirm if all records in the recipe should be deleted.	--
290069	Security request to confirm if all records in the recipe should be deleted.	--
290070	The record specified is not in the import file.	Check the source of the record number or record name (constant or tag value).
290071	During the editing of record values, a value was entered which exceeded the low limit of the recipe tag. The entry is discarded.	Enter a value within the limits of the recipe tag.
290072	When editing record values, a value was entered which exceeds the high limit of the recipe tag. The entry is discarded.	Enter a value within the limits of the recipe tag.

Number	Effect/causes	Remedy
290073	An action (e.g. saving a record) failed due to an unknown error. The error corresponds to the status alarm IDS_OUT_CMD_EXE_ERR in the large recipe view.	--
290074	While saving, it was detected that a record with the specified number already exists but under another name.	Overwrite the record, change the record number or cancel the action.
290075	A record with this name already exists. The record is not saved.	Please select a different record name.
290110	The default values could not be set due to an error.	--
290111	The Recipes subsystem cannot be used. Recipe views have no content and recipe-specific functions will not be performed. Possible causes: <ul style="list-style-type: none"> • An error occurred while transferring the recipes. • The recipe structure was changed in ES. When the project was downloaded again, the recipes were not transferred with it. This means that the new configuration data is not being transferred to the old recipes on the device. 	Transfer the project to the device again, together with the recipes (the corresponding check box in the Transfer dialog must be checked).

300000 - Alarm_S alarms

Number	Effect/causes	Remedy
300000	Faulty configuration of process monitoring (e.g. using PDiag or S7-Graph): More alarms are queued than specified in the specifications of the CPU. No further ALARM_S alarms can be managed by the PLC and reported to the HMI devices.	Change the PLC configuration.
300001	ALARM_S is not registered on this PLC.	Select a controller that supports the ALARM_S service.

310000 - Report system alarms

Number	Effect/causes	Remedy
310000	An attempt is being made to print too many reports in parallel. Only one log file can be output to the printer at a given time; the print job is therefore rejected.	Wait until the previous active log was printed. Repeat the print job if necessary.
310001	An error occurred on triggering the printer. The report is either not printed or printed with errors.	Evaluate the additional system alarms related to this alarm. Repeat the print job if necessary.

320000 - Alarms

Number	Effect/causes	Remedy
320000	The movements have already been indicated by another device. The movements can no longer be controlled.	Deselect the movements on the other display units and select the motion control screen on the required display unit.

Number	Effect/causes	Remedy
320001	The network is too complex. The faulty addresses cannot be indicated.	View the network in STL.
320002	No diagnosable alarm message (error) selected. The unit associated with the alarm message could not be selected.	Select a diagnostics alarm from the ZP_ALARM alarm screen.
320003	No alarm message (error) exists for the selected unit. The detail view cannot visualize any networks.	Select the defective unit from the overview screen.
320004	The required signal states could not be read by the PLC. The faulty addresses cannot be found.	Check the consistency between the configuration on the display unit and the PLC program.
320005	The project contains ProAgent elements which are not installed. ProAgent diagnostic functions cannot be performed	In order to run the project, install the optional ProAgent package.
320006	You have attempted to execute a function which is not supported in the current constellation.	Check the type of the selected unit.
320007	No error-triggering addresses were found on the networks. ProAgent cannot indicate any faulty addresses.	Switch the detail screen to STL layout mode and check the status of the addresses and exclusion addresses.
320008	The diagnostic data stored in the configuration are not synchronized with those in the PLC. ProAgent can only indicate the diagnostic units.	Transfer the project to the HMI device again.
320009	The diagnostic data stored in the configuration are not synchronized with those in the PLC. The diagnostic screens can be operated as usual. ProAgent may be unable to show all diagnostic texts.	Transfer the project to the HMI device again.
320010	The diagnostic data stored in the configuration are not synchronized with those in STEP7. The ProAgent diagnostics data is not up-to-date.	Transfer the project to the HMI device again.
320011	A unit with the corresponding DB number and FB number does not exist. The function cannot be executed.	Check the parameters of the "SelectUnit" function and the units selected in the project.
320012	The "Step sequence mode" dialog is no longer supported.	Use the ZP_STEP step sequence screen from the corresponding standard project for your project. Instead of calling the Overview_Step_Sequence_Mode function, call the "FixedScreenSelection" function using ZP_STEP as the screen name.
320014	The selected PLC cannot be evaluated for ProAgent. The Alarm view assigned to the "EvaluateAlarmDisplayFault" system function could not be found.	Check the parameters of the "EvaluateAlarmDisplayFault" system function.

330000 - GUI alarms

Number	Effect/causes	Remedy
330022	Too many dialogs are open on the HMI device.	Close all dialogs you do not require on the HMI device.
330026	The password will expire after the number of days shown.	Enter a new password.

350000 - GUI alarms

Number	Effect/causes	Remedy
350000	PROFIsafe packages have not arrived within the necessary period. There is a communication problem with the F-CPU. RT is terminated.	Check the WLAN connection.
350001	PROFIsafe packages have not arrived within the necessary period. There is a communication problem with the F-CPU. The PROFIsafe connection is re-established.	Check the WLAN connection.
350002	An internal error has occurred. Runtime is terminated.	Internal error
350003	Feedback concerning the connection established with the F-CPU. The Emergency-Off buttons are active immediately.	--
350004	PROFIsafe communication was set and the connection was cleared. The Runtime can be terminated. The Emergency-Off buttons are deactivated immediately.	--
350005	Incorrect address configured for the F-slave. No PROFIsafe connection.	Check and modify the address of the F slave in WinCC flexible ES.
350006	The project has started. At the start of the project, the enabling buttons must be checked for functionality.	Press the two enabling buttons one after another in the "Enable" and "Panic" positions.
350008	The wrong number of fail-safe buttons was configured. No PROFIsafe connection.	Change the number of fail-safe buttons in the project.
350009	The device is in Override mode. It may no longer be possible to detect the location because transponder detection fails.	Exit Override mode.
350010	Internal error: The device has no fail-safe buttons.	Send the device back. Worldwide contact person

A.3 Things to remember during configuration

A.3.1 Configuring the terminal ID

A.3.1.1 Overview

Introduction

You can divide a system into several zones or functional areas by using several connection boxes. For this purpose it may be necessary for different system screens to be displayed, depending on the connection box used.

This is achieved by means of connection point recognition.

Note

The following sections are intended for the configuration engineer of the HMI device.

Note

If the same screens and functions are used predominantly for all PLCs and the PLCs are of the same type, the configuration can be designed in such a way that only one PLC connection is configured.

The configuration engineer can enable switching between various PLCs by means of a control object.

Connection point recognition

You can implement connection point recognition as follows:

- Reading out of the box ID set in the connection box by the HMI device
- Wiring the connection box to a digital input of the PLC

Note**Connection point recognition via box ID**

The solution with box ID works with various plant configurations.

Note

The "Project recognition" area pointer ensures that the HMI device is connected to the PLC which supports the project.

The "Project recognition" area pointer can only be associated with one PLC per project. You will find further information in the "WinCC flexible communication" manual.

Note

A box ID cannot be set up on a Mobile Panel 170 connection box. In this case connection point recognition is only possible via the digital input of the PLC.

A.3.1.2 Connection Point Recognition via Box ID

Box ID

You can read out the box ID of the connection box to which the mobile panel is connected in the project.

Note

If you connect a Mobile Panel 277 to a Mobile Panel 170 connection box, the box ID will always deliver the value 255.

Requirements

- You have set the box ID at all connection boxes.
- Each connection box is assigned a unique box ID.

Example for the evaluation of the current box ID

In order to ensure that the box ID is forwarded to the PLC correctly when the HMI device is connected, undertake the configuration in WinCC flexible as follows:

1. Specify the connection to the PLC in the "Connections" editor. Activate the "Coordination" area pointer to ensure that the life bit is available on the PLC.
2. Create three tags in the "Tag" editor.
 - Internal tag: "Internal_Box-ID"
 - External tag: "Auxiliary_Tag"
 - External tag: "External_Box-ID"
3. Open the "Device settings" editor.
4. Select the "Internal_Box-ID" tag at "Zone ID/Terminal ID" in the "Settings for Runtime" area.

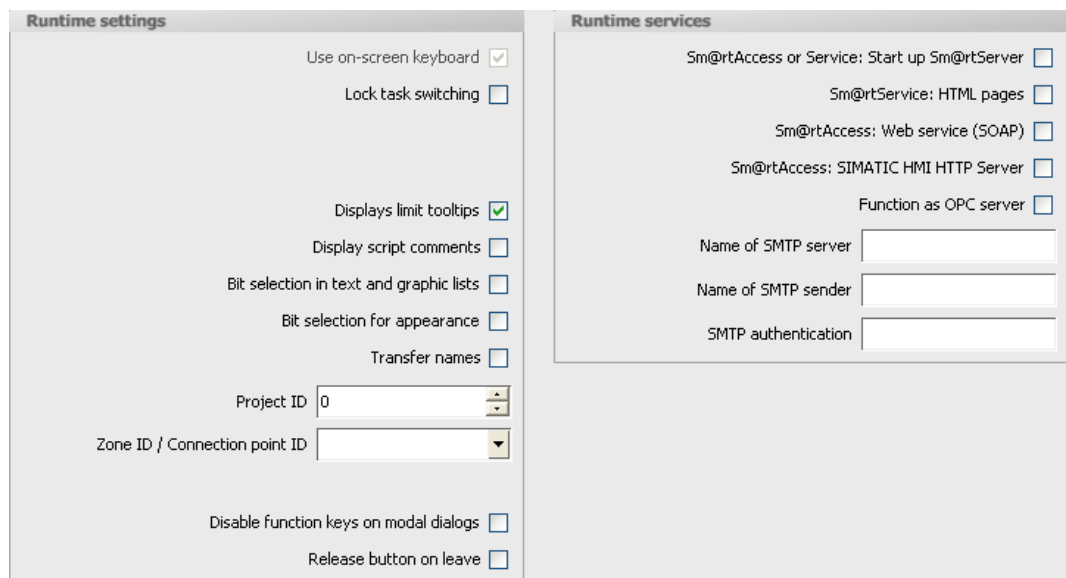

5. When you connect the HMI device to the connection box, the box ID is written automatically into the "Internal_Box-ID" tag.
 - Once communication between the HMI device and the PLC has been established, the current value in the PLC is automatically written to the "External_Box-ID" tag. The "Auxiliary Tag" is required so that the current value of the box ID can be transferred to the PLC.
 - A program in the PLC evaluates the live bit. After the control program has recognized the creation of communication, the control program changes the current value once in the "Auxiliary Tag" tag. This brings about a change of value.
 - The value change in the "Auxiliary_Tag" triggers performance of the "SetValue" system function. The system function allocates the "External_Box-ID" the value of the "Internal_Box-ID" tag.
6. To configure this system function open the properties view of the "Auxiliary Tag". Click "Change value" in the properties window of the "Auxiliary_Tag" tag in the "Events" group. The "Function list" dialog box opens. Click the first line of the function list. The list opens, showing the system functions available in the project.
7. Select the "SetValue" system function from the "Calculation" group.
8. Select the "External_Box-ID" tag at "Tag (output)".
9. Select the "Internal_Box-ID" tag at "Value".

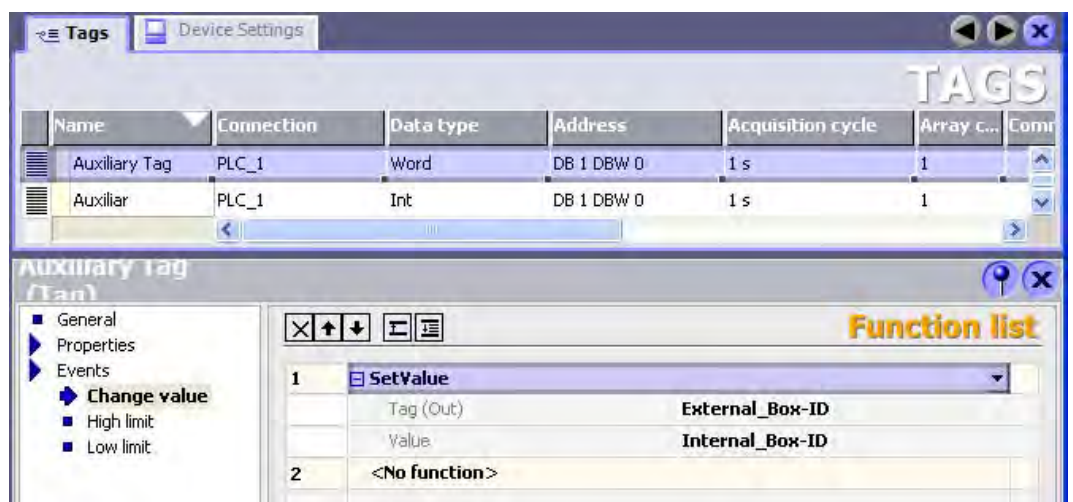

Result

The box ID of the connection box to which the mobile panel is connected is transferred to the PLC.

See also

Setting the box ID at the connection box (Page 56)

A.3.2 Ensuring consistent values for operator controls

Introduction

The WinCC flexible system functions can be used to evaluate the operator controls of the HMI device and to activate the LEDs of the function keys and illuminated pushbuttons.

The states of the following control elements are then transferred to the PLC via tags:

- Direction pulses of the handwheel
- The switching state of the function keys
- The switching state of the key-operated switch
- The switching state of the illuminated pushbuttons

NOTICE
Ensuring data consistency The direct assignment of an operator control tag to a process can lead to data inconsistency and malfunctions. The tag values for operator controls must be consistent. You must make provisions for consistency when you configure your project in WinCC flexible.

Development of data inconsistency

The direct assignment of a tag with process interconnection to an operator control can lead to inconsistent values at the operator control, HMI device, and the PLC:

1. The HMI device is connected to the connection box.
2. The HMI device starts.
3. The values of the operator control elements are determined and entered in tags on the HMI device.
4. Communication between the HMI device and PLC is established.
5. After communication has been established, the old values of the tags are transferred from the PLC into the tags of the HMI device.
6. Not until a change has been carried out to an operator control element, is the valid value written into the tag of the HMI device and transferred to the PLC.

Procedure

Proceed as follows:

1. Specify the connection to the PLC in the "Connections" editor.
2. Activate the "Coordination" area pointer to ensure that the life bit is available on the PLC.
3. Create three tags in the "Tag" editor.
 - Internal tag "Status_Operator_Control"
 - External tag "Auxiliary tag"
 - External tag "Operator_Control_PLC"

4. For globally allocated illuminated pushbutton, key-operated switch, and handwheel:

- Open the template in the "Screens" editor.
- Select the operator control element in the template.
- Click on the "General" group in the Properties view.
- Select the "Status_Control_Element" tag at "Tag" in the "Settings" section.

The value is written to the "Status_Operator_Control" tag after you have activated the operator control. You can additionally configure the "LED-Tag" tag for the illuminated pushbuttons, in order to control the integrated LEDs.

The following figure shows the assignment of tags, using an illuminated pushbutton as example.

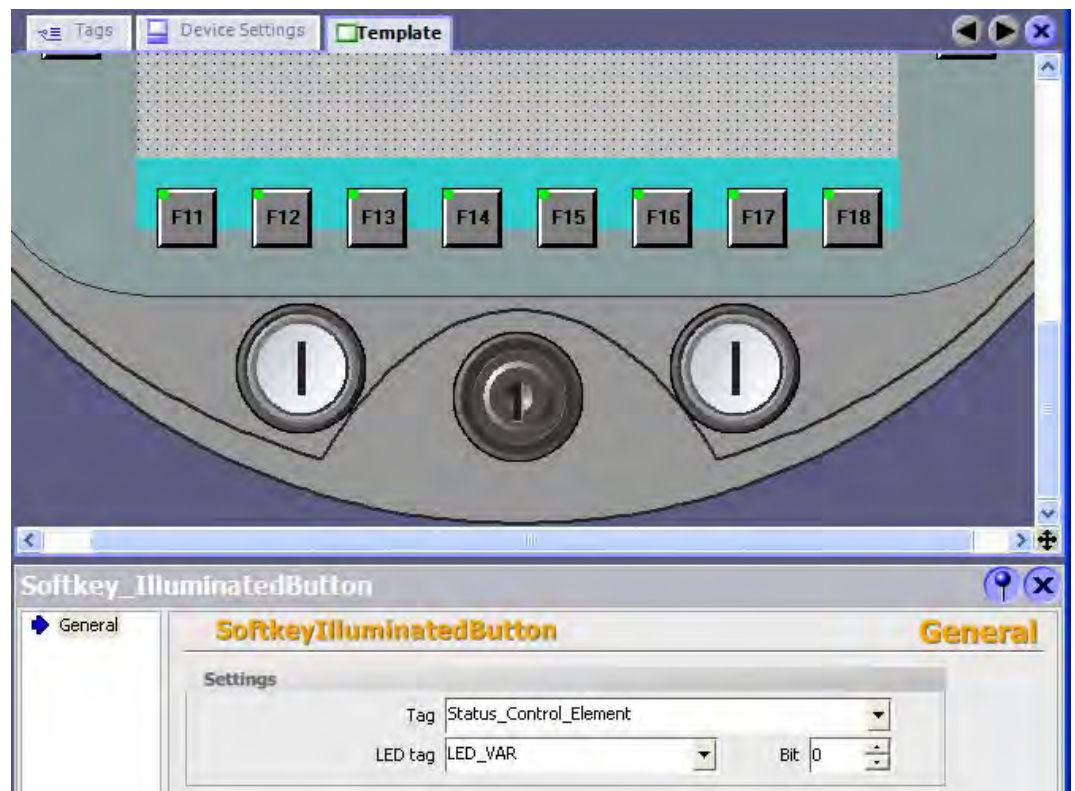

5. For locally allocated handwheel:

- In the "Screens" editor, open the screen to which you want to assign the local handwheel function.
- Configure the function "ConnectTagWithHandwheel" on a command button or directly into the screen structure.
- Select the "Status_Operator_Control" tag as "Value."

The value is written to the "Status_Operator_Control" tag after you have activated the operator control.

The "Control_Element_PLC" tag writes the value of the "Status_Control_Element" tags into the PLC. The "SetValue" system function has to be configured at the "Status_Control_Element" tag in order for the value to be transferred.

6. Open the properties window of the "Status_Control_Element" tag.

7. Click "Change value" in the properties view of the "Status_Control_Element" tag in the "Events" group.
The "Function list" dialog box opens.
8. Click the first line of the function list.
The list opens, showing the system functions available in the project.
9. Select the "SetValue" system function from the "Calculation" group.
10. Select the "Operator_Control_PLC" tag at "Tag (output)."
11. Select the "Status_Operator_Control" tag as "Value."



When communication between the HMI device and the PLC has been made, the current PLC old value will be automatically written to the "External_Box-ID" tag. The "Auxiliary Tag" is required so that the current value of the box ID can be transferred to the PLC.

A program in the PLC evaluates the live bit. After the control program has recognized the creation of communication, the control program changes the current value once in the "Auxiliary Tag" tag. This causes a change in value. The value change in the "Auxiliary_Tag" triggers performance of the "SetValue" system function. The system function assigns the value of the "Status_Control_Element" tag again to the "Control_Element_PLC" tag.

12. To configure the system function, open the Properties view of the "Auxiliary Tag".
13. Click "Change value" in the properties window of the "Auxiliary_Tag" tag in the "Events" group.
The "Function list" dialog box opens.
14. Click the first line of the function list.
The list opens, showing the system functions available in the project.
15. Select the "SetValue" system function from the "Calculation" group.
16. Select the "Operator_Control_PLC" tag at "Tag (output)."
17. Select the "Status_Operator_Control" tag as "Value."

Result

The values for the operator control elements are consistent between operator control element, HMI device and PLC.

Abbreviations

ANSI	American National Standards Institution
CPU	Central Processing Unit
CSV	Comma Separated Values
CTS	Clear To Send
DC	Direct Current
DCD	Data Carrier Detect
DHCP	Dynamic Host Configuration Protocol
DIL	Dual-in-Line (electronic chip housing design)
DNS	Domain Name System
DP	Distributed I/O
DSN	Data Source Name
DSR	Data Set Ready
DTR	Data Terminal Ready
IO	Input and Output
ESD	Components and modules endangered by electrostatic discharge
EMC	Electromagnetic Compatibility
EN	European standard
ES	Engineering System
ESD	Components and modules endangered by electrostatic discharge
GND	Ground
HF	High Frequency
HMI	Human Machine Interface
IEC	International Electronic Commission
IF	Interface
IP	Internet Protocol
LED	Light Emitting Diode
MAC	Media Access Control
MOS	Metal Oxide Semiconductor
MPI	Multipoint Interface (SIMATIC S7)
MS	Microsoft
MTBF	Mean Time Between Failures
n. c.	Not connected
OP	Operator Panel
PC	Personal Computer
PG	Programming device
PPI	Point-to-Point Interface (SIMATIC S7)

RAM	Random Access Memory
PELV	Protective Extra Low Voltage
RJ45	Registered Jack Type 45
RTS	Request to send
RxD	Receive Data
SD Card	Security Digital Card
SELV	Safety Extra Low Voltage
SP	Service Pack
PLC	Programmable Logic Controller
STN	Super Twisted Nematic
Sub-D	Subminiature D (plug)
TAB	Tabulator
TCP/IP	Transmission Control Protocol/Internet Protocol
TFT	Thin Film Transistor
TTY	Teletype
TxD	Transmit Data
UL	Underwriter's Laboratory
USB	Universal Serial Bus
WINS	Windows Internet Naming Service

Glossary

Acknowledge

Acknowledgment of an alarm confirms that it has been noted.

Alarm logging

Output of user-specific alarms to a printer, in parallel to their output to the HMI device screen.

Alarm, acknowledging

Acknowledgment of an alarm confirms that it has been noted.

Alarm, activated

Moment at which an alarm is triggered by the PLC or HMI device.

Alarm, deactivated

Moment at which the initiation of an alarm is reset by the PLC.

Alarm, user-specific

A user-specific alarm designates a certain operating status of the plant connected to the HMI device via the PLC.

Automation device

PLC of the SIMATIC S5 series such as the S5-115U

Automation system

Controller of the SIMATIC S7 series such as a SIMATIC S7-300

Bootloader

Used to start the operating system. Automatically started when the HMI device is switched on. After the operating system has been loaded, the Loader opens.

Configuration software

Software used to generate projects used for the purpose of process visualization. An example of configuring software is WinCC flexible.

Configuring PC

A configuring PC is a programming device or PC on which plant projects are created using an engineering software.

Display duration

Defines whether a system alarm is displayed on the HMI device and the duration of the display.

Diversity

In technology, diversity refers to a strategy to increase the failsafe abilities. This is why systems are designed redundantly. However, a conscious effort is made to use different realizations and individual systems that are not similar in structure.

EMC

Electromagnetic compatibility is the ability of electrical equipment to function properly in its electromagnetic environment without influencing this environment.

Event

Functions are triggered by defined incoming events. Events can be configured. Events which can be assigned to a button include "Press" and "Release", for example.

Field array

Area reserved in configured screens for the input and output of values.

Flash memory

Non-volatile memory with EEPROM chips, used as mobile storage medium or as memory module installed permanently on the motherboard.

Function keys

Key on the HMI device which supports user-specific functions. A function is assigned to the key in the configuration. The assignment of the keys may be specific to an active screen or not.

Half Brightness Life Time

Time period after which the brightness reaches 50% of the original value. The specified value is dependent on the operating temperature.

Hardcopy

Output of the screen content to a printer.

HMI device

An HMI device is a device used for the operation and monitoring of machines and plants. The statuses of the machine or plant are indicated by means of graphic elements or by indicator lamps on the HMI device. The operating elements of the HMI device allow the operator to interact with the processes of the machine or plant.

HMI device image

A file that can be transferred from the configuring PC to the HMI device. The HMI device image contains the operating system and elements of the runtime software required to run a project.

I/O field

An I/O field enables the input or output of values on the HMI device which are transferred to the PLC.

Infotext

An infotext is a configured information on objects within a project. Infotext for an alarm, for example, may contain information on the cause of the fault and troubleshooting routines.

Object

An object is a component of a project. Example: screen or alarm. Objects are used to view or enter texts and values on the HMI device.

Operating element

Component of a project used to enter values and trigger functions. A button, for example, is an operating element.

Plant

General term referring to machines, processing centers, systems, plants and processes which are operated and monitored on an HMI device.

PLC

A PLC is a general term for devices and systems with which the HMI device communicates, e.g. SIMATIC S7.

PLC job

A PLC job triggers a function for the PLC at the HMI device.

Process visualization

Visualization of technical processes by means of text and graphic elements. Configured plant screens allow operator intervention in active plant processes by means of the input and output data.

Project

Result of a configuration using a configuration software. The project normally contains several screens with embedded system-specific objects, basic settings and alarms. The project file of a project configured in WinCC flexible is saved under the file name extension *.hmi.

You need to distinguish between a project on the configuring PC and that on an HMI device. A project may be available in more languages on the configuring PC than can be managed on the HMI device. The project on the configuring PC can also be set up for different HMI devices. Only the runtime project that has been generated for the respective HMI device can be transferred to it.

Project file

File generated from the runtime project file for use on the HMI device. The project file is normally not transferred and remains on the configuring PC.

The file name extension of a source file is *.hmi.

Project file, compressed

Compressed format of the project file. The compressed project file can be transferred together with the runtime project file to the respective HMI device. For this purpose, backtransfer must be enabled in the project on the configuring PC. The compressed project file is normally stored on an external memory card.

The file extension of a compressed file is *.pdz.

Recipe

Combination of tags forming a fixed data structure. The data structure configured can be assigned data on the HMI device and is then referred to as a record. The use of recipes ensures that all the assigned data is transferred synchronously to the PLC during the transfer of a record.

Runtime project file

File generated from the project file for a specific HMI device. The runtime project file is transferred to the corresponding HMI device and used to operate and monitor plants.

The extension of a compressed file is *.pdz.

Runtime software

The runtime software is a process visualization software used to test a project on a configuring PC.

screen

Form of the visualization of all logically related process data for a plant. The visualization of the process data can be supported by graphic objects.

Screen object

Configured object used to display or operate the plant, e.g. rectangle, I/O field or alarm view.

STEP 7

STEP 7 is the programming software for SIMATIC S7, SIMATIC C7 and SIMATIC WinAC PLCs.

STEP 7 Micro/WIN

STEP 7 Micro/WIN is the programming software for SIMATIC S7-200 PLCs.

Symbolic I/O field

A symbolic I/O field is a field for the input and output of the value. Contains a list of default entries from which one can be selected.

System alarm

A system alarm is assigned to the "System" alarm class. A system alarm refers to internal states on the HMI device and the PLC.

Tab sequence

During configuration, this defines the sequence in which objects are activated on pressing the <TAB> key.

Tag

Defined memory location to which values can be written to and read from. This can be done from the PLC or the HMI device. Based on whether the tag is interconnected with the PLC or not, we distinguish between "external" tags (process tags) and "internal" tags.

Transfer

Transfer of a runtime project from the configuring PC to the HMI device.

"Transfer" mode

An operating mode of the HMI device in which an executable project is transferred from the configuring PC to an HMI device.

Index

A

- Accessory kit, 20
- Acknowledge
 - Alarm, 226
 - Error alarm, 226
- Activate
 - Password protection, 128
- Address assignment
 - TCP/IP network, 152
- Addressing, 150
- Admin, 218, 219
- Agency, 7
- Alarm, 221
 - Acknowledge, 226
 - Alarm indicator, 223
 - Display, 223
 - Editing, 227
 - Functional scope, 27
- Alarm buffer, 222
 - Functional scope, 27
- Alarm class, 221, 225
- Alarm event, 221
- Alarm group, 222
- Alarm indicator, 223
- Alarm line, 223
- Alarm log, 222
- Alarm report, 222
- Alarm view, 223
 - Extended, 224
 - Simple, 224
- Alarm window, 225
- ALARM_S, 27
- Alphanumeric
 - Screen keyboard, 197
- Alphanumeric value
 - Changing, 197
 - Entering, 197
- Ambient conditions
 - Climatic, connection box, 47
 - Mechanical, 45
 - Mobile panel, 46
 - Tested for, 46
- Applications
 - Mobile Panel 277, 15
- Authorization, 212
- Automatic

- Transfer, 170
- Automation License Manager, 185

B

- Backing up, 167, 174, 175, 177, 213
 - Registry Information, 119, 132
 - Temporary files, 132
 - To memory card, 119, 160
 - With ProSave, 177
 - With WinCC flexible, 175
- Backlighting
 - Reducing, 135
 - Setting, 120
- Backtransfer, 168, 172
- Backup, 119, 160
- Backup time
 - Internal clock, 265, 266
- Bar, 202
- Basic knowledge
 - Required, 4
- Booting, 138
- Box ID, 317, 318
 - Setting, 57
- Brightness
 - Changing, 134
- Browser
 - Home page, 119
 - Setting, 119
- Bus connection, 30
- Bus parameters
 - Profile, 145
- Byte assignment
 - Direct keys, 92, 104

C

- Cable
 - Connecting, 69
- Cable cross-section, 67
- Calibrating
 - Touch screen, 126
- Care, 255
- CE approval, 34
- Certificate
 - Delete, 119, 159
 - Importing, 119, 159
 - LED, 119

- Certificates, 119
- Certifications, 34
- Changing
 - Brightness, 134
 - Monitor setting, 134
 - User data, 218
- Character repeat, 119
 - Screen keyboard, 123
 - Setting, 123
- Charge level
 - LED, 119
- Charging
 - Electrostatic, 285
- Circuit diagram, 89, 102
- Clearance
 - Connection box, 48
 - Wall holder, 48
- Climatic
 - Storage conditions, 43
 - Transport conditions, 43
- Closing
 - Project, 219
- Column sequence
 - Alarm view, 225
- Combination
 - Connecting cable-connection-box, 16, 24
- Compatibility conflict, 174
- Compress
 - Program memory S5, 32
- Configuration diagram
 - Configuring PC, 64, 74
 - MPI/PROFIBUS DP, 64
 - PLC, 61
 - PLC on connection box DP, 61
 - PLC on connection box PN, 63
 - Printer, 66
- Configuration phase, 165
- Configure
 - Network, 150
- Configuring
 - Connection box DP port, 62
 - Operating system, 115
 - Screen keyboard, 119, 122
- Configuring PC, 165
 - Configuration diagram, 64, 74
 - Connecting, 64, 74
- Connecting
 - Cable, 69
 - Configuring PC, 64, 74
 - Connecting cables, 75
 - Connection box, 54
 - Connection sequence, 54
 - Equipotential bonding, 59
 - PLC, 61, 64
 - Printer, 66
- Connecting cable DP
 - Post connector, 271
 - RJ45 plug connector, 270
- Connecting cable PN
 - Post connector, 272
 - RJ45 plug connector, 271
- Connecting cables
 - Connecting, 75
 - Design, 21
- Connection, 30
 - Electrical, 53
- Connection box
 - Box ID, 318
 - Clearance, 48
 - Combination with connecting cable, 24
 - Connecting, 54
 - Connection point recognition, 24, 317
 - EMC-compliant installation, 41
 - Mounting position, 47
 - Open, 55
 - Recovery time, 23
 - Rotary encoder switch, 56
 - Safety instruction, 54, 84, 101
 - Variants, 23
- Connection box Basic
 - Switching states Emergency Stop circuit, 113
 - Switching states Stop circuit, 113
 - Wiring examples, 281
- Connection box DP
 - DIL switch, 62
 - Fast connector, 274
 - IF1 port, 273
 - Location of the ports, 272
 - Overall dimensions, 262
 - Power failure, 268
 - Recovery time, 268
 - Terminal strip 1, 273
 - Terminal strip 2, 276
- Connection box Plus
 - Switching states Emergency Stop circuit, 111
 - Switching states Stop circuit, 111
 - Wiring examples, 277
- Connection box PN
 - Fast connector, 275
 - IF1 port, 275
 - LEDs, 114
 - Location of the ports, 274
 - Overall dimensions, 263
 - Power failure, 269
 - Recovery time, 269
 - Terminal strip 1, 275

- Terminal strip 2, 276
- Connection example, 282
 - Enabling button, 283
 - Safety circuit device, 284
 - STOP button, 284
 - To safety category 3, 282
 - with safety category 3, 283, 284
- Connection graphic
 - Equipotential bonding, 60
 - Power supply, 67
- Connection point recognition, 24, 317
- Connection sequence, 54
- Connection to PLCs
 - Number, 30
- Control Panel
 - MPI, 144
 - Open, 118
 - Operating, 120
 - Password protection, 116
 - PROFIBUS, 144
 - Screen keyboard, 121
- Cookies, 157
- Creating
 - Recipe data record, 239, 246
- C-Tick mark (Australia), 35

D

- Data channel
 - Enabling, 145
 - Locking, 145
 - Parameter assignment, 120, 145
- Data consistency, 320
- Data flow, 233
- Date, 119
 - Entering, 198
 - Setting, 129
 - Synchronizing, 131
- Date format, 132
- Date/time properties, 119, 129
- Deactivating
 - Password protection, 129
- Decimal, 196
- Default gateway, 152
- Degree of protection
 - Safety instruction, 56, 73
- Delay time
 - Setting, 120, 141
- Delete
 - Certificate, 159
 - Recipe data record, 241, 248
 - Users, 219

Design

- Connecting cables, 21
- Design variations, 17
- Device name
 - For network operation, 151
 - Setting, 120
- DHCP, 152
- Direct key, 91, 104, 192
 - Bit coding, 93
 - Byte assignment, 92, 104
 - Functional scope, 29
 - Reaction time, 95
- Display
 - Alarm, 223
 - Infotext, 199, 226
 - Specifications, 265
 - Technical data, 264
- Display format, 195
- DNS, 152
 - Server, 150
- Documentation
 - Conventions, 6
 - Enclosed, 51
 - Getting Started, 5
 - Operating instructions, 5
 - User manual, 4
- Double-click, 119
 - Setting, 125
- Drop down list box, 199

E

- EC Declaration of Conformity, 34
- Editing
 - Alarm, 227
 - Recipe data record, 240, 247
- Electrical
 - Installation, 53
- Electrical potential difference, 59
- Electrostatic charging, 285
- Electrostatic discharge
 - Precautions, 286
- Element list, 235, 246
- E-Mail
 - Setting, 120, 155
- EMC, 41
 - Guideline, 34
- Emission, 37, 42
- Enabling button, 38, 88, 101
 - Circuit diagram, 89, 102
 - Danger arising from improper use, 39
 - Operating, 88, 102

- Panic activation, 90, 103
 - Switch settings, 89, 102
- Enabling device, 38
- Encryption, 157
- Enhanced recipe view, 234
- Entering
 - Alphanumerical value, 197
 - By means of function key, 201
 - Date, 198
 - Numerical value, 196
 - Recipe data record, 253
 - Symbolic value, 199
 - Text box, 194
 - Time, 198
 - Via HMI objects, 189
- Equipotential bonding
 - Cable, 59
 - Connecting, 59
 - Connection graphic, 60
 - Requirements, 59
- Error alarm
 - Acknowledge, 226
- ESD
 - Abbreviations, 285
 - Labeling, 285
 - Safety instruction, 54
- Ethernet settings
 - IP address, 152
- Evaluating
 - Operator controls, 80
- Exporting
 - Recipe data record, 251
- Extended alarm view, 224
- Extended user view, 214

F

- Fast connector
 - Assignment, 274, 275
- Feedback
 - Optical, 191
- Front view, 17, 19, 257, 259
- Function
 - Additional, 29
- Function keys
 - Global function assignment, 201
 - Input via, 201
 - Labeling, 106
 - Local function assignment, 201
- Function test, 78
- Functional scope
 - Alarm buffer, 27

- ALARM_S, 27
- Alarms, 27
- Graphics list, 27
- Infotext, 29
- Limit value monitoring, 27
- Log, 28
- Recipe, 28
- Safety, 29
- Scaling, 27
- screen, 28
- Tag, 27
- Text list, 27

G

- Gauge, 202
- Graphics list
 - Functional scope, 27

H

- Handwheel
 - Application, 96
 - Evaluate incremental values, 96
 - Operating, 85
 - Reaction time, 95
- High frequency radiation, 34
- HMI device
 - Cold restart, 138
 - Information, 119, 139
 - Ports, 72
 - Restarting, 119
 - Specifications, 265
 - Switch off, 78
 - Technical data, 264
- HMI Input Panel
 - Options, 122
- Home page
 - Internet, 156
- Host cable
 - Safety instruction, 75

I

- Identification, 153
- IF1 port
 - Assignment, 273, 275
- Illuminated pushbutton
 - Application, 97
 - Bit assignment, 97
 - Function principle, 86

- Importing
 - Certificate, 159
 - Recipe data record, 252
- Infotext
 - Display, 199, 226
 - Functional scope, 29
- Initial startup, 165
- Input Panel, 119
- Input unit, 80, 81
 - Specifications, 266
 - Technical data, 264
- Installation
 - Electrical, 53
 - EMC-compliant, 41
- Installing
 - Option, 167, 182, 184
- Interference
 - Pulse-shaped, 41
 - Sinusoidal, 42
- Interlocking mechanism, 76
- Internal clock, 130, 265, 266
- Internet
 - Home page, 156
 - Options, 119
 - Search engine, 156
 - Security settings, 119
 - Service, 7, 256
 - Settings, 120, 154
 - Support, 7, 256
- Internet Explorer, 117
- Internet options
 - Privacy, 157
- IP address
 - Ethernet, 152
 - Setting, 119
- IP65 degree of protection
 - Safety instruction, 71

K

- Keyboard
 - Safety instruction, 80
- Keyboard properties, 119, 123
- Key-operated switch
 - Application, 96
 - Bit assignment, 96
 - Operating, 87

L

- Labeling
 - Function keys, 106

- Labeling strips
 - Attaching, 108
 - Dimensions, 107
 - Exchange, 108
 - Printing, 106
- LAN connection, 119
- Language change
 - Functional scope, 29
- Layout
 - Slider control, 204
 - Sm@rtClient view, 209
 - Trend view, 205
- LED
 - Connection box PN, 114
 - HMI device information, 119
 - Memory information, 140
 - System information, 140
- LED function key
 - Application, 95
 - Bit assignment, 95
- License key, 185
 - Transferring, 168, 186
 - Transferring back, 168, 187
- Limit value
 - For password, 213
 - For user, 213
 - For user view, 213
- Limit value monitoring
 - Functional scope, 27
- Limit value test, 195
- Loader
 - Buttons, 115
 - Open, 116
- Log
 - Functional scope, 28
- Logoff
 - Users, 216
- Logoff time, 212
- Logon
 - User, 215
- Logon data, 153

M

- Maintenance, 255, 256
- Manual
 - Production sequence, 254
 - Transfer, 169
- Mechanical
 - Storage conditions, 43
 - Transport conditions, 43

- Memory
 - Specifications, 266
 - Technical data, 265
 - Memory card
 - Backup to, 160
 - Inserting, 105
 - Restoring file system, 132
 - Restoring from, 160
 - Unplug, 105
 - Memory information
 - LED, 140
 - Memory management, 119, 164
 - Mobile Panel
 - Attaching, 110
 - Design variations, 17
 - Enabling button, 88, 101
 - Front view, 17
 - Holding, 109
 - Information, 139
 - Mounting position, 47
 - Operating, 109
 - Overall dimensions, 257, 259
 - Ports, 72, 265, 266
 - Rear view, 18, 20
 - Replugging, 24
 - Side view, 18, 19
 - STOP button, 82, 98
 - Switching on, 77
 - Testing, 77
 - Mobile Panel 277
 - Applications, 15
 - Front view, 19
 - Mode
 - Transfer, 77
 - Monitor setting
 - Changing, 119, 134
 - Monitoring device
 - SIRIUS 3TK2841, 283
 - Monitoring mode
 - Sm@rtClient view, 210
 - Mounting location
 - Wall holder, 48
 - Mounting position
 - Connection box, 47
 - Mobile Panel, 47
 - Wall holder, 51
 - Mouse properties, 119, 125
 - MPI
 - Configuration diagram, 64
 - Setting, 119, 144
 - Strip cable, 58
 - Multi-key operation, 190, 201
- ## N
- Name server, 152
 - Setting, 119
 - Network
 - Configure, 150
 - Logon data, 119
 - Set up, 149
 - Setting, 152
 - Network & dial-up connections, 119
 - Network ID, 119
 - Network operation
 - Device name, 151
 - Options, 120, 154
 - Nominal voltage, 50
 - Number format, 132
 - Numerical
 - Screen keyboard, 195
 - Numerical value
 - Changing, 196
 - Decimal places, 196
 - Display format, 195
 - Entering, 196
 - Limit value test, 195
- ## O
- Offices, 7
 - Offline
 - Operating mode, 166
 - Recipe tag, 238
 - Test, 173
 - Online
 - Operating mode, 166
 - Recipe tag, 238
 - Test, 173
 - OP properties, 119
 - Device, 139
 - Memory monitoring, 164
 - Persistent storage, 133
 - Touch, 126
 - Open
 - Connection box, 55
 - Loader, 116
 - open-loop control
 - time-dependent reaction, 131
 - Open-loop control
 - Configuration graphic, 61, 63
 - Operating
 - Control Panel, 120
 - Enabling button, 88, 102
 - Feedback, 190
 - Handwheel, 85

- Key-operated switch, 87
- Mobile Panel, 109
- Project, 189
- Recipe menu, 246
- Recipe screen, 239, 246
- Safety instruction, 110
- Slider control, 204
- STOP button, 82, 84, 98, 100
- Switches, 203
- Trend view, 206
- With external keyboard, 190
- With external mouse, 190
- Operating instructions
 - Purpose of, 3
 - Scope, 4
- Operating mode, 166
 - Changing, 166
 - Offline, 166
 - Online, 166
 - Transfer, 166
- Operating safety
 - Standards, 36, 38
- Operating system
 - Configuring, 115
 - Safety instruction, 74
 - Update via ProSave, 181
 - Update via WinCC flexible, 179
 - Updating, 167, 178, 179
- Operation feedback, 190
- Operator control
 - Recipe view, 239
- Operator controls
 - Data consistency, 320
 - Evaluating, 80
 - Function, 79
 - Selection, 80
 - Simple recipe view, 245
- Optical feedback, 191
- Option
 - Installing, 167, 182
 - Installing with ProSave, 184
 - Installing with WinCC flexible, 182
 - Removing, 167, 182
 - Removing with ProSave, 184
 - Removing with WinCC flexible, 183
- Options, 30
 - Network operation, 120, 154
- Overall dimensions
 - Connection box DP, 262
 - Connection box PN, 263
 - Mobile Panel 277, 257, 259
 - Wall holder, 261

P

- Panic activation
 - Enabling button, 90, 103
- Parameter assignment
 - Data channel, 120, 145
- Password, 212
 - Backing up, 213
 - Restoring, 213
 - Specifying, 128
- Password list, 212
- Password properties, 119, 128
- Password protection, 116, 119
 - Activate, 128
 - Deactivating, 129
- PC/PPI
 - Cable, 74
- PC/PPI cable, 26
- PELV, 68
- Permission in remote control, 211
- Pin assignment
 - Post connector, 271, 272
 - RJ45 plug connector, 270, 271
 - RS 485 port, 269
 - USB socket, 270
- PLC
 - Connecting, 61, 64
 - Number, 30
 - Protocol, 30
 - Reading recipe data record, 243, 249
 - Transferring recipe data record, 244, 250
- PLC_User, 218, 219
- Pocket Internet Explorer, 117
- Ports, 72
 - Configuring, 62
 - Mobile Panel 277, 265, 266
- Power failure, 174, 268, 269
- Power supply
 - Cable cross-section, 67
 - Connection graphic, 67
- Precautions
 - Electrostatic discharge, 286
- Printer
 - Configuration diagram, 66
 - Connecting, 66
 - Setting, 119
- Printer connection
 - Setting, 136
- Printer properties, 119, 137
- Printing
 - Labeling strips, 106
 - Via network printer, 150
- Process control phase, 165

- Production sequence
 - Manual, 254
 - PROFIBUS DP, 16
 - Configuration diagram, 64
 - Setting, 144
 - Strip cable, 58
 - PROFINET, 16, 149
 - Addressing, 150
 - Strip cable, 58
 - PROFINET IO
 - Disabling direct keys, 148
 - Enabling direct keys, 148
 - Safety instruction, 63
 - Setting, 119
 - Program memory S5
 - Compress, 32
 - Project
 - Closing, 219
 - Offline testing, 173
 - Operating, 189
 - Reuse, 167
 - Testing online, 173
 - Transferring, 165, 167
 - Proper use, 34
 - Protective cover, 55
 - Protocol
 - PLC, 30
 - Proxy
 - Server, 119, 154, 156
 - Setting, 119
- R**
- Radiation
 - High frequency, 34
 - Radio interference, 37
 - Emission, 42
 - Reading
 - Recipe data record, 243
 - Reading out
 - Recipe data record, 249
 - Real-time clock
 - Internal, 130
 - Rear view, 18, 20
 - Rechargeable battery, 24
 - Safety instruction, 69
 - State, 163
 - Rechargeable buffer battery, 24
 - Recipe, 230
 - Control, 231
 - Data flow, 233
 - Data record, 231
 - Field of application, 229
 - Functional scope, 28
 - Recipe screen, 234
 - Recipe view, 234
 - Synchronizing tags, 242
 - Recipe data record
 - Creating, 239, 246
 - Delete, 241, 248
 - Editing, 240, 247
 - Entering, 253
 - Exporting, 251
 - Importing, 252
 - Reading from PLC, 243, 249
 - Synchronize with PLC, 240
 - Transferring to PLC, 244, 250
 - Recipe list, 235, 245
 - Recipe menu
 - Operating, 246
 - Recipe screen, 236
 - Operating, 239, 246
 - Overview, 236
 - Recipe tag
 - Offline, 238
 - Online, 238
 - Synchronizing, 237, 242
 - Recipe view, 234
 - Expanded, 234
 - Menu commands, 245
 - Operator control, 239
 - Operator controls, 245
 - Simple, 235
 - Recommissioning, 165
 - Record list, 235, 245
 - Recovery time, 23, 78, 219, 268, 269
 - Regional and language settings, 119, 131
 - Regional settings, 132
 - Registered trademarks, 7
 - Registry Information
 - Backing up, 119, 132
 - Regulations for the prevention of accidents, 33
 - Remote control
 - Forcing permission, 211
 - Start, 210
 - Removing
 - Option, 167, 182, 183, 184
 - Repairs, 256
 - Replacement key set, 256
 - Replugging
 - Mobile Panel, 24
 - Reset to factory settings, 167, 179
 - Restore, 119, 160
 - Restoring, 167, 174, 176, 177, 213
 - From memory card, 119, 132, 160

- With ProSave, 177
 - With WinCC flexible, 176
 - Return Center, 256
 - Reuse
 - Project, 167
 - Reverse polarity protection, 67
 - Risk analysis, 38
 - Risk evaluation
 - Special operation, 38
 - Risk from improper use
 - Enabling button, 39
 - RJ45 socket
 - Safety instruction, 72
 - Rotary encoder switch, 56
 - RS 485 port
 - Pin assignment, 269
 - Ruler
 - Trend view, 206
- S**
- S7 transfer settings, 119
 - Safety
 - Functional scope, 29
 - Standards, 36, 38
 - Safety category 3
 - Connection example, 282
 - Safety circuit device
 - SIRIUS 3TK2822, 284
 - SIRIUS 3TK2841, 284
 - Safety instruction
 - Backlighting, 135
 - Category 0 Stop, 40, 84, 100
 - Category 1 Stop, 40, 84, 100
 - Changed tag name, 242
 - Cold restart, 138
 - Compatibility conflict, 174
 - Compressed project file, 168
 - Connecting cables, 53
 - Connection box, 41, 54, 84, 101
 - Connection sequence, 54
 - Data channel, 178
 - Data loss, 178
 - Degree of protection, 56, 73
 - Direct key, 192
 - Disconnecting Mobile Panel, 112
 - Electrostatic charging, 285
 - Enabling button, 33, 39
 - Equipotential bonding conductor, 59
 - ESD, 54
 - General, 37
 - High frequency radiation, 34
 - IP65 degree of protection, 23, 71
 - Keyboard, 80
 - License key, 174, 182
 - Malfunctions, 69
 - Memory distribution, 140
 - Multi-key operation, 190
 - Observe grounding measures, 286
 - Operating the Mobile Panel, 110
 - Path, 142
 - Power failure, 174
 - Preventing inadvertent operation, 255
 - PROFINET IO, 63
 - Project file, 142
 - Rechargeable battery, 25, 69
 - Recipe data record in background, 235
 - Releasing the STOP button, 113
 - Remote control for channel 1, 146
 - Remove connecting cable, 192
 - Reset to factory settings, 74
 - RJ45 socket, 72
 - Sample cycle time, 95
 - STOP button, 33, 40, 41, 51, 84, 100, 101
 - Storage, 43
 - Switching infotext, 200
 - Touch screen, 80, 81
 - Transfer mode, 143, 147
 - Transfer mode channel 2, 147
 - Transport, 43
 - Unintentional action, 201
 - Unintentional transfer mode, 146
 - USB Host-to-Host cable, 75
 - Voltage supply, 37
 - Safety isolation, 68
 - Safety regulations, 33
 - Scaling
 - Functional scope, 27
 - screen
 - Functional scope, 28
 - Screen keyboard, 119, 194
 - Alphanumerical, 197
 - Change layout, 121
 - Character repeat, 123
 - Configuring, 122
 - For Control Panel, 121
 - Keyboard level, 197
 - Language change, 197
 - Numerical, 195
 - Representation types, 121
 - Screen saver, 120, 135
 - Setting, 135
 - Search engine
 - Internet, 156
 - Security settings, 119

- Security system, 212
- Selection
 - Operator controls, 80
- Service
 - On the Internet, 7, 256
- Service pack, 256
- Set up
 - Network, 149
- Setting
 - Backlighting, 120
 - Box ID, 57
 - Browser, 119
 - Character repeat, 123
 - Date, 129
 - Date format, 132
 - Date/Time, 119
 - Delay time, 120, 141
 - Device name, 120
 - Double-click, 125
 - E-Mail, 120
 - E-mail connection, 155
 - IP address, 119
 - Language, 193
 - MPI, 119, 144
 - Name server, 119
 - Network, 152
 - Number format, 132
 - Printer connection, 136
 - PROFIBUS, 144
 - PROFINET IO, 119
 - Proxy, 119
 - Regional data, 132
 - Screen saver, 135
 - Station number, 57
 - Time, 129
 - Time format, 132
- Setting language, 193
- Setting the station number, 57
- Settings
 - Internet, 120
 - Language, 119
 - Regional, 119
 - S7-Transfer, 119
- SIBE Switzerland Certification Service, 35
- Side view, 18, 19, 258, 260
- Siemens HMI input panel options, 119
- Signal
 - Mobile panel connected, 277
- Simple alarm view, 224
- Simple recipe view, 235
 - Menu commands, 245
 - Operator controls, 245
- Simple user view, 214
- Slider control, 204
- Sm@rtClient view, 209, 210
 - Monitoring mode, 210
 - Usage, 209
- SMTP server, 154
- Software options, 30
- Sort order
 - Alarm view, 225
- Special operation
 - Risk evaluation, 38
- Specifications
 - Display, 265
 - HMI device, 265
 - Input unit, 266
 - Memory, 266
 - Mobile Panel 277, 266
 - Supply voltage, 265, 266, 267, 268
 - Weight, 267, 268
- Standard input unit, 80, 81
- Start
 - HMI device, 138
- Status / control, 207
- Status Force
 - Touch operation, 208
- Stop
 - Safety instruction, 84, 100
- STOP button, 40
 - Operating, 82, 84, 98, 100
 - Release, 83, 100
 - Release safety instructions, 113
 - Safety instruction, 40, 41, 84, 100
- Storage conditions, 43
- Stripping insulation
 - MPI/PROFIBUS DP cable, 58
 - PROFINET cables, 58
- Subnet mask, 152
- Supply voltage, 267, 268
 - Specifications, 265, 266
- Support
 - On the Internet, 7, 256
- Switch off
 - HMI device, 78
- Switch setting
 - Enabling button, 89, 102
- Switches, 203
- Switching on
 - Mobile Panel, 77
- Symbolic value
 - Changing, 199
 - Entering, 199
- Synchronizing
 - Date and time, 131
 - Recipe tag, 237, 242

- System, 140
 - System alarm
 - Meaning, 287
 - Parameters, 287
 - System functions, 91, 104
 - System information, 120
 - LED, 140
 - System properties, 120
 - Device name, 151
 - General, 140
 - Memory, 141
- T**
- Tag
 - Functional scope, 27
 - Task planner
 - Functional scope, 29
 - TCP/IP address, 152
 - Technical data
 - Display, 264
 - HMI device, 264
 - Input unit, 264
 - Memory, 265
 - Mobile Panel 277, 265
 - Technical Support, 7
 - Temporary files
 - Backing up, 132
 - Test
 - For ambient conditions, 46
 - Testing
 - Mobile Panel, 77
 - Text box, 194
 - Text list
 - Functional scope, 27
 - Time, 119
 - Entering, 198
 - Setting, 129
 - Synchronizing, 131
 - Time format, 132
 - Time zone
 - Setting, 129
 - Time-dependent reactions, 131
 - Touch screen
 - Calibrating, 119, 126
 - Safety instruction, 80, 81
 - Training center, 7
 - Transfer, 165, 166, 168
 - Automatic, 170
 - Cancel, 77
 - Manual, 169
 - Transfer mode
 - Unintentional, 146
 - Via MPI, 143
 - Via PROFIBUS DP, 143
 - Transfer settings, 120, 145
 - Channel, 146
 - Directories, 141
 - Transferring
 - License key, 168, 186
 - Project, 165, 167
 - Recipe data record, 244, 250
 - Transferring back
 - License key, 168, 187
 - Transport conditions, 43
 - Transport damage, 51
 - Trend view, 205
 - Trends
 - Functional scope, 29
 - Limit violation, 205
- U**
- UL approval, 35
 - Unintentional action, 190, 201
 - Unintentional transfer mode, 146
 - Updating
 - About ProSave, 181
 - Operating system, 178
 - Via WinCC flexible, 179
 - Usage
 - Conditions, 45
 - In industry, 37
 - In residential areas, 37
 - Mobile Panel 277, 15
 - With additional measures, 45
 - USB socket, 73
 - Pin assignment, 270
 - USB/PPI cable, 26
 - User
 - Logon, 215
 - User data
 - Backing up, 213
 - Changing, 218
 - Restoring, 213
 - User group, 212
 - User manual, 4
 - User name, 153
 - User view, 213
 - Extended, 214
 - Simple, 214

Users, 212
Admin, 218, 219
Changing, 216
Delete, 219
Logoff, 216
PLC_User, 218, 219

V

Value table
Trend view, 205
VBScript
Functional scope, 29
Voltage supply, 37

W

Wall holder, 25
Clearance, 48
Mounting location, 48
Mounting position, 51
Overall dimensions, 261
Weight, 267, 268
WinCC flexible /Sm@rtService, 30
WinCC flexible internet settings, 120
E-mail, 154
Windows CE taskbar, 115
Password protection, 116
WINS, 152
Server, 150
Wiring
Enabling button, 282
Wiring examples
Connection box Basic, 281
Connection box Plus, 277