

# SIEMENS

## SIMATIC NET

### S7-300 - Industrial Ethernet / PROFINET CP 343-1 Lean

Equipment Manual

Preface

---

Properties / services

1

Performance data

2

Requirements for use

3

LEDs

4

Installation, connection,  
commissioning, removal

5

Configuration and  
operation

6

Diagnostics and  
maintenance

7

Technical specifications

8

Approvals

A

References

B

Manual Part B



01/2023

C79000–G8976–C198–09

## Legal information

### Warning notice system

This manual contains notices you have to observe in order to ensure your personal safety, as well as to prevent damage to property. The notices referring to your personal safety are highlighted in the manual by a safety alert symbol, notices referring only to property damage have no safety alert symbol. These notices shown below are graded according to the degree of danger.

 <b>DANGER</b>
indicates that death or severe personal injury <b>will</b> result if proper precautions are not taken.
 <b>WARNING</b>
indicates that death or severe personal injury <b>may</b> result if proper precautions are not taken.
 <b>CAUTION</b>
indicates that minor personal injury can result if proper precautions are not taken.
<b>NOTICE</b>
indicates that property damage can result if proper precautions are not taken.

If more than one degree of danger is present, the warning notice representing the highest degree of danger will be used. A notice warning of injury to persons with a safety alert symbol may also include a warning relating to property damage.

### Qualified Personnel

The product/system described in this documentation may be operated only by **personnel qualified** for the specific task in accordance with the relevant documentation, in particular its warning notices and safety instructions. Qualified personnel are those who, based on their training and experience, are capable of identifying risks and avoiding potential hazards when working with these products/systems.

### Proper use of Siemens products

Note the following:

 <b>WARNING</b>
Siemens products may only be used for the applications described in the catalog and in the relevant technical documentation. If products and components from other manufacturers are used, these must be recommended or approved by Siemens. Proper transport, storage, installation, assembly, commissioning, operation and maintenance are required to ensure that the products operate safely and without any problems. The permissible ambient conditions must be complied with. The information in the relevant documentation must be observed.

### Trademarks

All names identified by ® are registered trademarks of Siemens AG. The remaining trademarks in this publication may be trademarks whose use by third parties for their own purposes could violate the rights of the owner.

### Disclaimer of Liability

We have reviewed the contents of this publication to ensure consistency with the hardware and software described. Since variance cannot be precluded entirely, we cannot guarantee full consistency. However, the information in this publication is reviewed regularly and any necessary corrections are included in subsequent editions.

# Preface

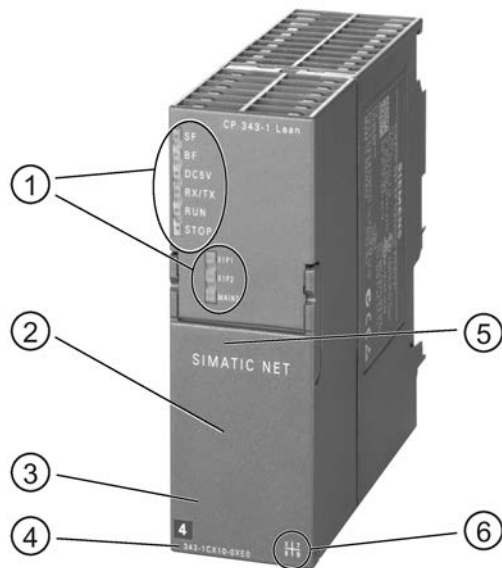

## Legend:

- ① LEDs
- ② Under the front panel:  
PROFINET interface, 2 x 8-pin RJ-45 jack
- ③ Under the front panel:  
- Socket for 24 V DC power supply  
- Slider for setting the ground connector
- ④ Article number
- ⑤ Under the front panel:  
printed text with MAC addresses and firmware version
- ⑥ X = placeholder for hardware product version

Figure 1 CP 343-1 Lean

## Validity and product names

This description contains information on the following product:

- CP 343–1 Lean  
Article number 6GK7343-1CX10-0XE0  
Hardware product version 7  
Firmware version V3.0  
Communications processor for SIMATIC S7–300 / C7–300
- CP 343–1 Lean  
Article number 6AG1343-1CX10-2XE0  
Hardware product version 7

Firmware version V3.0  
Communications processor for SIMATIC S7–300 / C7–300 - conformal coating

---

**Note**

**Names**

- In this document, the term "CP" is used instead of the full product name.
  - The name STEP 7 is used for the configuration tool instead of the names STEP 7 V5.5 and STEP 7 Professional.
- 

**New in this edition**

- New approvals (CCC / UKEX)
- Editorial revision

**Replaced documentation**

This manual replaces the manual edition 12/2018.

**Innovations and compatibility with the predecessor product**

---

**Note**

You will find the new functions of the module in the section Enhanced functions (Page 11).

Make sure that you read the information relating to enhanced functions and restrictions in the section module replacement / upgrading (Page 62).

---

**Address label: Unique MAC address for the CP**

The CP is supplied with total of 3 default MAC addresses with the following assignment:

- PROFINET interface
- One MAC address for each of the 2 Ethernet ports of the PROFINET interface

The MAC addresses of the Ethernet ports are required only for detection and evaluation of neighborhood and topology relations.

The MAC address of the PROFINET interface is printed on the housing.

## Structure of the documentation

The documentation for this device consists of the following parts:

- Manual Part A: Configuration manual "Configuring and Commissioning S7CPs for Industrial Ethernet", see references /1/ (Page 73).
- Manual Part B: Manual "CP 343-1 Lean" (this manual)
- Program blocks for SIMATIC NET S7 CPs - programming manual, see references /10/ (Page 76)

Contains the detailed description of the program blocks for the following services:

- Open communication services
- Access coordination with FETCH/WRITE
- Connection and system diagnostics
- Programmed connections and IP configuration
- PROFINET IO

## Current manual edition on the Internet

You will also find the current version of this manual on the Internet pages of Siemens Automation Customer Support under the following entry ID:

Link: (<http://support.automation.siemens.com/WW/view/en/23643456>)

## CP documentation on DVD

You can find the documentation on the product and the configuration on the DVD supplied with the product. This DVD contains the product manuals valid at the time it is created.

## Version History / Current Downloads for the SIMATIC NET S7 CPs

The "Version History/Current Downloads for SIMATIC NET S7 CPs" provides information on all CPs available up to now for SIMATIC S7 (Industrial Ethernet, PROFIBUS and IE/PB Link).

An up-to-date version of this document can be found at on the Internet under the entry ID:

Link: (<https://support.industry.siemens.com/cs/ww/en/view/109474421>)

## License conditions

---

### Note

#### Open source software

The product contains open source software. Read the license conditions for open source software carefully before using the product.

---

You will find license conditions in the following document on the supplied data medium:

- OSS\_CP3431\_86.pdf

## Firmware

The firmware is signed. This ensures that only firmware created by Siemens can be downloaded to the device.

## Note on firmware/software support

Check regularly for new firmware/software versions or security updates and apply them. After the release of a new version, previous versions are no longer supported and are not maintained.

## Security information

Siemens provides products and solutions with industrial security functions that support the secure operation of plants, systems, machines and networks.

In order to protect plants, systems, machines and networks against cyber threats, it is necessary to implement – and continuously maintain – a holistic, state-of-the-art industrial security concept. Siemens' products and solutions constitute one element of such a concept.

Customers are responsible for preventing unauthorized access to their plants, systems, machines and networks. Such systems, machines and components should only be connected to an enterprise network or the internet if and to the extent such a connection is necessary and only when appropriate security measures (e.g. firewalls and/or network segmentation) are in place.

For additional information on industrial security measures that may be implemented, please visit

Link: (<http://www.siemens.com/industrialsecurity>)

Siemens' products and solutions undergo continuous development to make them more secure. Siemens strongly recommends that product updates are applied as soon as they are available and that the latest product versions are used. Use of product versions that are no longer supported, and failure to apply the latest updates may increase customers' exposure to cyber threats.

To stay informed about product updates, subscribe to the Siemens Industrial Security RSS Feed under

Link: (<https://www.siemens.com/cert>)

## FAQs on the Internet

You will find detailed information (FAQs) on using the CP described here on the Internet at the following address (entry type "FAQ"):

Link: (<http://support.automation.siemens.com/WW/view/en/10806067>)

## SIMATIC NET glossary

The SIMATIC NET glossary describes terms that may be used in this document.

You will find the SIMATIC NET glossary in the Siemens Industry Online Support at the following address:

Link: (<http://support.automation.siemens.com/WW/view/en/50305045>)

## Recycling and disposal



The product is low in pollutants, can be recycled and meets the requirements of the WEEE directive 2012/19/EU "Waste Electrical and Electronic Equipment".

Do not dispose of the product at public disposal sites. For environmentally friendly recycling and the disposal of your old device contact a certified disposal company for electronic scrap or your Siemens contact.

Keep to the local regulations.

You will find information on returning the product on the Internet pages of Siemens Industry Online Support:

Link: (<https://support.industry.siemens.com/cs/ww/en/view/109479891>)





# Table of contents

	<b>Preface</b> .....	<b>3</b>
<b>1</b>	<b>Properties / services</b> .....	<b>11</b>
	1.1 Application .....	11
	1.2 Enhanced functions .....	11
	1.3 Communication services .....	13
	1.4 Other services .....	14
	1.5 The CP as Web server .....	15
<b>2</b>	<b>Performance data</b> .....	<b>17</b>
	2.1 Transmission and reaction times .....	17
	2.2 Number of possible Ethernet/PROFINET connections .....	17
	2.3 Characteristics of S7 communication .....	18
	2.4 Characteristic data of the SEND/RECEIVE Interface .....	19
	2.5 PROFINET IO characteristic data .....	20
	2.6 Characteristic data of the integrated switch .....	21
<b>3</b>	<b>Requirements for use</b> .....	<b>23</b>
	3.1 Operation in control device families .....	23
	3.2 Project engineering .....	25
	3.3 Program blocks .....	27
<b>4</b>	<b>LEDs</b> .....	<b>29</b>
<b>5</b>	<b>Installation, connection, commissioning, removal</b> .....	<b>33</b>
	5.1 Important notes on using the device .....	33
	5.1.1 Notices on use in hazardous areas .....	33
	5.1.2 Notes on use in hazardous areas according to ATEX / IECEx / UKEX .....	33
	5.1.3 Notes on use in hazardous areas according to UL HazLoc / FM .....	34
	5.2 Installation, removal and repairs in hazardous areas .....	35
	5.3 Installing and connecting up .....	36
	5.4 Disassembly .....	42
<b>6</b>	<b>Configuration and operation</b> .....	<b>43</b>
	6.1 Security recommendations .....	43
	6.2 Project engineering .....	46
	6.3 Controlling the mode .....	46
	6.4 Network settings .....	47

- 6.5 Influence of MPI on connections via Industrial Ethernet ..... 49
- 6.6 PROFINET IO when operating other services at the same time..... 49
- 6.7 Effects of multicast communication on RT communication ..... 50
- 6.8 IP configuration ..... 50
- 6.8.1 Detection of double IP addressing in the network..... 50
- 6.8.2 Obtain IP address via DHCP: CP STOP on expiry of the lease ..... 51
- 6.9 Media redundancy ..... 51
- 6.10 Timeofday synchronization ..... 51
- 6.11 SNMP agent..... 52
- 6.12 Possible security gaps on standard IT interfaces: preventing unauthorized access..... 54
- 6.13 Programmed communication connections ..... 55
- 6.13.1 Programmed communication connections with FB55 IP\_CONFIG..... 55
- 6.13.2 Programmed communications connections - assigning parameters to the ports ..... 55
- 6.14 Permitted length of ICMP packets..... 55
- 7 Diagnostics and maintenance ..... 57**
- 7.1 Diagnostics options ..... 57
- 7.2 Memory reset / reset to factory defaults ..... 58
- 7.3 Loading new firmware..... 60
- 7.4 Replacing a module ..... 61
- 7.4.1 Replacing older modules..... 61
- 7.4.2 module replacement / upgrading ..... 62
- 7.4.3 Replacing a module without a programming device ..... 63
- 8 Technical specifications..... 65**
- A Approvals..... 67**
- B References ..... 73**
- Index..... 79**

# Properties / services

## 1.1 Application

The CP 343-1 Lean communications processor is intended for operation in a SIMATIC S7-300 or SIMATIC C7 automation system. It allows the connection of the S7-300 to Industrial Ethernet and supports PROFINET IO.

To integrate the CP in a linear bus or a ring, to connect a further Ethernet device or to use PROFINET media redundancy, a 2-port ERTEC real-time switch with autocrossing, autonegotiation and autosensing was integrated.

## 1.2 Enhanced functions

### Abbreviations used with the CP 343-1 Lean module

The module abbreviations used below for the CP 343-1 Lean (for example CX10) correspond to the last four characters of the mid section of the order number.

### Requirement for configuring new functions of firmware version V3.0

To use the features listed below, the following STEP 7 version is necessary:

- STEP 7 V5.5 + Service Pack 2 + Hotfix 1 + HSP 1056

With STEP 7 Professional V11.0 SP2, only the functions of firmware version V2.2 of the CP can be configured.

### Functional enhancements of the CX10 from firmware version V2.6 to V3.0 - can be used with STEP 7 V5.5

The following new functions can be used with the module with firmware version 3.0:

- "Shared device" function with PROFINET IO
- Use of PROFlenergy functionality

This requires the following PROFlenergy program blocks for the CP 343-1 in the "SIMATIC\_NET\_CP" library with the STEP 7 version listed above:

- PE\_Start\_CP, PE\_CMD\_CP, PE\_I\_DEV\_CP and the program block DS3\_WRITE\_CP for the use of power modules of the ET 200S for PROFlenergy.
- The supplementary program blocks FC0 to FC8 for the PROFlenergy response data can be found in the Standard Library.

You will find the documentation of the program blocks in the online help and in the manual for the program blocks, see References, /10/ (Page 76).

## 1.2 Enhanced functions

- New program block FB10 AG\_CNTEX for connection diagnostics
- Configuration of the IO devices in the STEP 7 "I-device" dialog box (and as previously using a GSDML file)

### Functional enhancements of the CX10 with firmware version V3.0 - regardless of the configuration tool used

- Advanced Web diagnostics (HTTP access) with the following additional options:
  - Diagnostics of S7 connections
  - Module identification
  - Expansion of Web diagnostics for The "Shared device" function
- Update center of Web diagnostics with the following functions:
  - Downloading firmware via the Web (HTTP access)
  - Downloading of language files for diagnostics buffer texts in STEP 7 format for new modules in the rack and for changing the language
- SNMP: Support of the MRP Monitoring MIB

### Enhanced functions of earlier firmware versions and predecessor modules

You will find an overview of the earlier firmware versions and predecessor modules in the version history of the Industrial Ethernet CPs on the Internet pages of Siemens Automation Customer Support under the following entry ID:

Link: (<http://support.automation.siemens.com/WW/view/en/56699406>)

You will find information about the characteristics of the individual firmware versions on the Internet pages of Siemens Automation Customer Support under the following entry ID:

Link: (<http://support.automation.siemens.com/WW/view/en/43409748>)

> Entry list > Entry type "Updates"

## 1.3 Communication services

The CP supports the following communication services:

- **PROFINET IO**

PROFINET IO allows direct access to IO devices over Industrial Ethernet.

- PROFINET IO device

Integration of the SIMATIC S7-300 automation system via the CP as an intelligent PROFINET IO device (I-device).

- Shared device

Individual submodules of the CP (IO device) can be assigned up to two PROFINET IO controllers in STEP 7 V5.5.

Note the information on configuring PROFINET IO systems with shared IO devices in the "PROFINET System Description", see references, /13/ (Page 76).

- **S7 communication and PG/OP communication with the following functions:**

- PG functions (including routing)
- Operator control and monitoring functions (HMI)
- Server for data exchange on S7 connections configured at one end only without communication blocks on the S7300 / C7300 station

- **Open communication services with the following functions:**

- SEND/RECEIVE interface ISOonTCP, TCP and UDP connections

UDP frame buffering on the CP can be disabled during configuration. When necessary, this allows you to achieve a shorter reaction time between the arrival of a UDP frame and its evaluation on the CPU.

- Multicast over UDP connection

The multicast mode is made possible by selecting a suitable IP address when configuring connections.

- FETCH/WRITE services (server; corresponding to S5 protocol) via ISO-on-TCP connections and TCP connections

The addressing mode can be configured for FETCH/WRITE access as S7 or S5 addressing mode.

- LOCK/UNLOCK with FETCH/WRITE services
- Connection diagnostics from the user program

## 1.4 Other services

The CP also provides the following additional services:

- **Media redundancy (MRP)**

Within an Ethernet network with a ring topology, the CP supports the media redundancy protocol MRP. You can assign the role of MRP client to the CP.

- **Time-of-day synchronization over Industrial Ethernet**

Time-of-day synchronization can be configured in the following modes:

- SIMATIC mode

The CP receives MMS time messages and synchronizes its local time and the time of the CPU.

Accuracy approx. +/- 1 second

You can choose whether or not the time of day is forwarded. The forwarding direction can also be selected (station > LAN or LAN > station).

or

- NTP mode (NTP: Network Time Protocol)

The CP sends timeofday queries at regular intervals to an NTP server and synchronizes its local time of day. The forwarding of the time-of-day to the CPU is optional.

Accuracy approx. +/- 1 second

- **Addressing using a factoryset MAC address**

The CP can be reached via the default MAC address to allow an IP address to be assigned.

- **SNMP agent**

The CP supports data queries over SNMP in version V1 (Simple Network Management Protocol). It delivers the content of certain MIB objects according to the MIB II standard, LLDP MIB, Automation System MIB and MRP Monitoring MIB.

- **Module access protection**

To protect the module from accidental or unauthorized access, protection can be configured at various levels.

- **IP configuration**

For the PROFINET interface, you can configure how and with which method the CP is assigned the IP address, the subnet mask and the address of a gateway.

As an alternative to STEP 7, you have the option of assigning the connection configuration via a block interface in the user program (FB55: IP\_CONFIG).

- **Web diagnostics**

With the aid of Web diagnostics, you can read out the diagnostics data from a station connected via the CP to a PG/PC with a Web browser.

This makes it possible to read the diagnostics buffers of the intelligent modules in the rack.

Using the integrated update center of the diagnostics pages, you can download new firmware versions and diagnostics buffer message texts.

If you do not require the functions, you can disable it in the STEP 7 configuration and disable port 80.

- **Connection diagnostics with the AG\_CNTEX program block**

With the AG\_CNTEX program block, you can diagnose connections.

- When necessary, you can activate or deactivate connections or initiate reestablishment of a connection.
- You can check the reachability of the connection partners using the ping function.
- You can find out which connection types are set up for the SEND / RECEIVE interface.

## 1.5 The CP as Web server

### Enabling the Web server function

To use the Web server functionality of the CP, enable the relevant option in STEP 7 in the module properties, "Web" parameter group. This enables port 80 of the CP.

If you no longer require the functions, deactivate the function. The Web server function is enabled as default.

### Web diagnostics

The CP provides you with the functionality of a web server for access by means of a web browser. The CP provides HTML pages for Web diagnostics. With the aid of Web diagnostics, you can read out the diagnostics data from a station connected via the CP to a PG/PC with an Internet browser.

With the following address, you have access to Web diagnostics:

`http:\\<IP address of the CP>`

Using the integrated update center of the diagnostics pages, you can download new firmware versions and language files for the diagnostics buffer message texts.

For detailed information on Web diagnostics, refer to the general Part A of this manual, /1/ (Page 73).

### **Diagnostics buffer entries**

When supplied, diagnostics buffer entries shown on diagnostics pages are always in English. This is the case whichever language you have selected to display the Web pages. How to download other language files to the CP and further information about Web diagnostics can be found in the general Part A of this manual.

### **Web browser**

To access the HTML pages on the CP, you require a Web browser. The following Web browsers are suitable for communication with the CP (other browsers also possible):

- Internet Explorer (recommended version: as of 7.0)
- Chrome (recommended version: as of 12.0)
- Opera (recommended version: as of 9.2)
- Firefox (recommended version: as of 4.0)

You will find these Web browsers, information and any necessary addons on the Internet.



## Performance data

### 2.1 Transmission and reaction times

#### Measured values on the Internet

---

##### Note

Measured values of transmission and reaction times over Ethernet, PROFIBUS and PROFINET networks for a series of configurations can be found on the Internet at the following address:

Link: (<http://www.siemens.com/automation/pd>)

---

### 2.2 Number of possible Ethernet/PROFINET connections

#### Maximum number of parallel connections

Table 2- 1 Maximum number of parallel connections

Characteristic	Explanation / values
Permitted number of simultaneous connections in total over Industrial Ethernet	12 maximum

#### Example of maximum load

You can, for example, operate:

- 4 S7 connections
- 4 ISO-on-TCP connections
- 2 TCP connections
- 2 UDP connections

## 2.3 Characteristics of S7 communication

Also:

- Further TCP connections for Web diagnostics
- PROFINET IO
  - As PROFINET IO device:
    - 1 PROFINET connection to a PROFINET IO controller
    - or
  - As shared device:
    - 2 PROFINET connections to 2 PROFINET IO controllers

## 2.3 Characteristics of S7 communication

### Number of connections

Table 2- 2 Number of connections for S7 communication

Characteristic	Explanation / values
Number of connections for S7 communication via Industrial Ethernet for: <ul style="list-style-type: none"> <li>• Operator control and monitoring functions (HMI)</li> <li>• S7 connections configured at one end</li> </ul>	Maximum 4 (one-ended connections) The number depends on the CPU type being used; the valid values can be found in /1/ (Page 73).
LAN Interface - data record length per protocol unit <ul style="list-style-type: none"> <li>• sending</li> <li>• receiving</li> </ul>	<ul style="list-style-type: none"> <li>• 240 bytes / PDU</li> <li>• 240 bytes / PDU</li> </ul>

## 2.4 Characteristic data of the SEND/RECEIVE Interface

The SEND/RECEIVE interface provides access to communication over TCP, ISOonTCP and UDP connections.

The following characteristics are important:

Table 2- 3 Characteristic data of the SEND/RECEIVE Interface

Characteristic	Explanation / values
Number of ISO-on-TCP connections + TCP connections + UDP connections in total	8 maximum Notes: <ul style="list-style-type: none"> <li>All UDP connections are also possible in multicast mode.</li> <li>Free UDP connections are supported by the CP.</li> </ul>
Maximum data length for the blocks AG_SEND (as of V4.0) and AG_RECV (as of V4.0)	AG_SEND and AG_RECV allow the transfer of blocks of data with the following length: <ul style="list-style-type: none"> <li>1 to 8192 bytes for ISO-on-TCP, TCP;</li> <li>1 to 2048 bytes for UDP.</li> </ul>
Restrictions for UDP	
<ul style="list-style-type: none"> <li>Transfer is not confirmed</li> </ul>	The transmission of UDP frames is unconfirmed, in other words the loss of messages is not detected or displayed by the send block (AG_SEND).
<ul style="list-style-type: none"> <li>No receipt of UDP broadcast</li> </ul>	To avoid communications overload of the CP due to high broadcast load, the CP does not allow receipt of UDP broadcasts.
<ul style="list-style-type: none"> <li>UDP frame buffering</li> </ul>	Size of the frame buffer with buffering enabled: 2 Kbytes Note: Following a buffer overflow, newly arriving frames are discarded.

### Execution times of the FCs AG\_SEND / AG\_RECV

The execution time required to process the FC blocks (AG\_SEND, AG\_RECV) required on the S7-300 / C7-300 CPU is decisive for the calculation of the CPU cycle times (OB1) for SEND/RECEIVE connections.

#### Note

Measurements of transmission and reaction times in Ethernet, PROFIBUS and PROFINET networks for a series of configurations can be found on the Internet at the following address:

Link: (<http://support.automation.siemens.com/WW/view/en/25209605>)

## 2.5 PROFINET IO characteristic data

### Configuration limits of the CP as an IO device and I-device

The CP supports the following maximum configuration if it is configured as a PROFINET IO device and as an I-device:

Table 2- 4 Configuration limits of the CP as a PROFINET IO device

Characteristic	Value
Maximum number of PROFINET IO connections	<ul style="list-style-type: none"> <li>• As PROFINET IO device: 1 PROFINET connection to a PROFINET IO controller</li> <li>or</li> <li>• As shared device: 2 PROFINET connections to 2 PROFINET IO controllers</li> </ul>
Size of the input area of the PROFINET IO device	512 bytes max. *
Size of the output area of the PROFINET IO device	512 bytes max. *
Size of the IO data area per sub module on the PROFINET IO device	<ul style="list-style-type: none"> <li>• Inputs: 240 bytes</li> <li>• Outputs: 240 bytes</li> </ul>
Size of the consistency area for a submodule	240 bytes
Maximum number of submodules	32
Size of the transfer area	240 bytes
Number of transfer areas	32

\* For the size of the user data, refer to the following section.

### Size of the user data

The size of the user data is calculated from the maximum frame size (gross 548 bytes) minus the following values: 1 for the CP itself, 1 per Interface, 1 per port, 1 for each plugged-in module in HW Config or per slot used.

Table 2- 5 Example of calculating the user data of the CP 343-1 as an IO device

Bytes	Explanation
548	Gross size of the frame
-1	for the CP itself
-1	for the Interface
-2	for 2 ports
-32	for the maximum number of pluggable modules
= 512	Net size of the user data *

\* By using fewer but larger modules, the amount of user data can be increased.

### Execution times of the FC blocks PNIO\_SEND / PNIO\_RECV

The execution time required to process the function blocks (PNIO\_SEND, PNIO\_RECV) required on the S7-300 CPU is decisive for the calculation of the reaction times in PROFINET IO.

---

#### Note

Measurements of transmission and reaction times in Ethernet, PROFIBUS and PROFINET networks for a series of configurations can be found on the Internet at the following address:

Link: (<http://support.automation.siemens.com/WW/view/en/25209605>)

---

## 2.6 Characteristic data of the integrated switch

### Learning addresses / deleting addresses (aging time)

The switch integrated in the CP (PROFINET interface) reads the source addresses included in the data packets. The switch therefore learns the addresses of the end devices connected via a port.

If the switch receives a data packet, it directs this packet only to the port via which the appropriate end node can be reached.

The switch monitors the age of the learned addresses. Addresses that exceed the "aging time" are deleted. The aging time is 5 minutes.

### Ports can be deactivated individually

The ports of the switch integrated in the CP can be deactivated individually in STEP 7 / HW Config. This can, for example, be used for service purposes.

To do this, open the properties dialog of the relevant port and select the "disabled" setting under "Options > Transfer medium / duplex".

The port is turned off completely when it is disabled. The corresponding LED on the device (for example X1P1) is then turned off.

2.6 Characteristic data of the integrated switch

## Requirements for use

### 3.1 Operation in control device families

The CP can be operated in the following device families:

- S7-300 stations with the following CPU types:
  - Standard
  - Compact
  - Modular
- C7 compact units in C7 packaging system

The following tables show the device environment in which the CP can be operated with the range of functions described here.

---

#### Note

The tables list the CPUs and devices released at the time this manual went to print. CPUs of the S7-300 or C7 control systems released later and not listed in the tables can also handle the range of functions described here.

---

Table 3- 1 Use of the CP with S7-300

CPU	Order number
CPU 312	6ES7312-1AD10-0AB0 6ES7312-1AE13-0AB0 6ES7312-1AE14-0AB0
CPU 312C	6ES7312-5BD00-0AB0 6ES7312-5BD01-0AB0 6ES7312-5BE03-0AB0
CPU 312 IFM	6ES7312-5AC02-0AB0 6ES7312-5AC82-0AB0
CPU 313	6ES7313-1AD03-0AB0
CPU 313C	6ES7313-5BE00-0AB0 6ES7313-5BE01-0AB0 6ES7313-5BF03-0AB0
CPU 313C-2 DP	6ES7313-6CE00-0AB0 6ES7313-6CE01-0AB0 6ES7313-6CF03-0AB0
CPU 313C-2 PtP	6ES7313-6BE00-0AB0 6ES7313-6BE01-0AB0 6ES7313-6BF03-0AB0

## 3.1 Operation in control device families

CPU	Order number
CPU 314	6ES7314-1AE00-0AB0 6ES7314-1AE04-0AB0 6ES7314-1AE84-0AB0 6ES7314-1AF10-0AB0 6ES7314-1AF11-0AB0 6ES7314-1AG13-0AB0 6ES7314-1AG14-0AB0 6AG1314-1AG14-2AY0 6AG1314-1AG14-7AB0
CPU 314 IFM	6ES7314-5AE03-0AB0 6ES7314-5AE10-0AB0 6ES7314-5AE82-0AB0 6ES7314-5AE83-0AB0
CPU 314C-2 DP	6ES7314-6CF00-0AB0 6ES7314-6CF01-0AB0 6ES7314-6CF02-0AB0 6ES7314-6CG03-0AB0
CPU 314C-2 PtP	6ES7314-6BF00-0AB0 6ES7314-6BF01-0AB0 6ES7314-6BF02-0AB0 6ES7314-6BG03-0AB0
CPU 315	6ES7315-1AF03-0AB0
CPU 315-2 DP	6ES7315-2AF03-0AB0 6ES7315-2AF83-0AB0 6ES7315-2AG10-0AB0 6ES7315-2AH14-0AB0 6AG1315-2AH14-2AY0 6AG1315-2AH14-7AB0
CPU 315-2 PN/DP	6ES7315-2EG10-0AB0 6ES7315-2EH13-0AB0 6ES7315-2EH14-0AB0 6AG1315-2EH14-2AY0 6AG1315-2EH14-7AB0
CPU 315F-2 DP	6ES7315-6FF00-0AB0 6ES7315-6FF01-0AB0 6ES7315-6FF04-0AB0 6ES7315-6FF04-2AB0 6AG1315-6FF04-2AB0 6AG1315-6FF04-2AY0
CPU 315F-2 PN/DP	6ES7315-2FH10-0AB0 6ES7315-2FH13-0AB0 6ES7315-2FJ14-0AB0 6AG1315-2FJ14-2AB0 6AG1315-2FJ14-2AY0
CPU 315T-2 DP	6ES7315-6TG10-0AB0 6ES7315-6TH13-0AB0
CPU 315T-3 PN/DP	6ES7315-7TJ10-0AB0
CPU 316-2 DP	6ES7316-2AG00-0AB0
CPU 317-2 DP	6ES7317-2AJ10-0AB0
CPU 317-2 PN/DP	6ES7317-2EJ10-0AB0 6ES7317-2EK13-0AB0 6ES7317-2EK14-0AB0 6AG1317-2EK14-2AY0 6AG1317-2EK14-7AB0



CPU	Order number
CPU 317F-2 DP	6ES7317-6FF00-0AB0 6ES7317-6FF03-0AB0 6ES7317-6FF04-0AB0 6AG1317-6FF04-2AB0
CPU 317F-2 PN/DP	6ES7317-2FJ10-0AB0 6ES7317-2FK13-0AB0 6ES7317-2FK14-0AB0 6AG1317-2FK14-2AB0 6AG1317-2FK14-2AY0
CPU 317T-2 DP	6ES7317-6TJ10-0AB0 6ES7317-6TK13-0AB0
CPU 317T-3 PN/DP	6ES7317-7TK10-0AB0
CPU 317TF-3 PN/DP	6ES7317-7UL10-0AB0
CPU 318-2 DP	6ES7318-2AJ00-0AB0
CPU 319-3 PN/DP	6ES7318-3EL00-0AB0 6ES7318-3EL01-0AB0
CPU 319F-3 PN/DP	6ES7318-3FL00-0AB0 6ES7318-3FL01-0AB0

Table 3- 2 Use of the CP with C7 control systems

C7	Order number
C7-613	6ES7613-1CA01-0AE03 6ES7613-1CA02-0AE3
CPU 614	6ES7614-1AH03-0AB3
C7-633 DP	6ES7633-2BF02-0AE03
C7-635 Key	6ES7635-2EC01-0AE3 6ES7635-2EC02-0AE3
C7-635 Touch	6ES7635-2EB01-0AE3 6ES7635-2EB02-0AE3
C7-636 Key	6ES7636-2EC00-0AE3
C7-636 Touch	6ES7636-2EB00-0AE3

## 3.2 Project engineering

### Software versions

At least the following version of STEP 7 is required:

Table 3- 3 Configuration tools for the CP 3431 Lean

STEP 7 versions	Function
STEP 7 V5.5, Service Pack 2, Hotfix 4, HSP 1056 or higher	Requirement for configuration of the CP with the functions of firmware version 3.0
STEP 7 Professional V11, Service Pack 2, Update 2 or higher	Requirement for configuration of the CP with the functions of firmware version 2.2

### Locating the support package

You can install the support package from your local file system if it is already stored there or from the Internet pages of Siemens Automation Customer Support.

- STEP 7 V5.5

You will find the support package (HSP) on the Internet at the following address:

Link: (<http://support.automation.siemens.com/WW/view/en/23183356>)

- STEP 7 Professional V11

You will find the support package on the Internet at the following addresses:

Link: (<http://support.automation.siemens.com/WW/view/en/28919804>)

On the Internet page, select the "Entry list" tab and the "Download" entry type.

### Installation of the support package

- STEP 7 V5.5

Install the HSP in STEP 7 / HW Config with the "Options" > "Install Hardware Updates" menu command.

You will find further information in the STEP 7 online help (under "HSP" or "Hardware update"). After installing the HSP, close STEP 7. After restarting STEP 7, the CP is in the catalog of HW Config.

- STEP 7 Professional V11

Install the support package in STEP 7 using the menu command "Options" > "Support packages".

The information system of STEP 7 will provide you with information (keyword "Support Packages" or "Installing Support Packages"). After installing the support package, close STEP 7. After restarting STEP 7, the CP is in the catalog.

### Downloading configuration data

It is possible to download the configuration data to the CP via MPI or LAN/Industrial Ethernet.

### See also

Link: (<http://support.automation.siemens.com/WW/view/en/18308132>)

### GSDML file for configuration in third-party systems

You will find the GSDML file for the CP described here on the Internet under the following entry ID (entry type "Download"):

Link: (<http://support.automation.siemens.com/WW/view/en/19698639>)

## 3.3 Program blocks

### Program blocks

For some communications services, there are preprogrammed program blocks (FCs / FBs) available as the interface in your STEP 7 user program.

Please note the documentation of the program blocks in the online help of STEP 7 or in the manual /10/ (Page 76).

---

#### Note

##### Current block versions

We recommend that you always use the latest block versions for all module types.

You will find information on the current block versions and the current blocks for download on the Internet under:

Link: (<https://support.industry.siemens.com/cs/ww/en/ps/15342/d/>)

With older module types, this recommendation assumes that you are using the latest firmware for the particular module type.

---



## LEDs

### LEDs

The display on the front panel consists of the following LEDs that indicate the operating mode and communications status.









Figure 4-1 LEDs of the CP 343-1 Lean CX10

The LEDs have the following meaning:

- SF: Group error
- BF: Bus fault on Ethernet interface
- DC5V: 5 VDC power supply via the backplane bus (green = OK)
- RX/TX: Acyclic data traffic, for example SEND/RECEIVE  
(not relevant for PROFINET IO data)
- RUN: RUN mode
- STOP: STOP mode
- X1P1: Link status / activity of Ethernet port 1
- X1P2: Link status / activity of Ethernet port 2
- MAINT: maintenance required (note/evaluate diagnostics buffer)

### Legend for the following LED tables





































The LED symbols in the following tables have the following significance:

Symbol	  		  	-
Meaning	ON	OFF	Flashing	any

## LEDs for displaying the operating mode

The different combinations of the LEDs on the front panel indicate the status:

Table 4- 1 LEDs: SF, BF, RUN, STOP

SF(red)	BF (red)	RUN (green)	STOP (yellow)	CP operating mode
	-			<ul style="list-style-type: none"> <li>Starting up after power "ON"</li> <li>or</li> <li>Stopped (STOP) with errors</li> </ul> <p>In this state, the CPU or intelligent modules in the rack remain accessible using PG functions.</p>
				Starting up (STOP → RUN)
				Running (RUN)
				Stopping (RUN → STOP)
				Stopped (STOP) In STOP mode, configuring and performing diagnostics on the CP remain possible.
-		-	-	Duplicate IP address detected
-			-	The CP is configured as a PROFINET IO device; there is no data exchange with the PROFINET IO controller.
				<p>Running (RUN) with error. Possible causes:</p> <ul style="list-style-type: none"> <li>Event display in conjunction with the MRP function. The CP diagnostics buffer provides detailed information.</li> <li>or</li> <li>Extended port diagnostics reports an error. Examples: <ul style="list-style-type: none"> <li>Current port setting (transmission medium, duplex) does not correspond to the configuration.</li> <li>Port interconnection does not correspond to the configuration.</li> </ul> </li> </ul>
				Loading using the Firmware Loader is active. *)
				Firmware activation after loading using the Firmware Loader is active. *)
				Firmware was successfully downloaded. *)
				Firmware download aborted. *)
				Module fault / system error

\*) Does not apply to loading via the update center in Web diagnostics.

## The "MAINT" LED

### Note





When the "MAINT" LED lights up, important error messages and/or diagnostics interrupts have occurred. The CP continues in RUN mode.

Check the entries in the diagnostics buffer of the device.

## LEDs for displaying the CP communications status

In addition to the LEDs that signal the CP state, the following LEDs provide information about the status of the CP interface to Industrial Ethernet.

Table 4- 2 LEDs: RX/TX, X1P1, X1P2

LED	Display	Meaning
RX/TX (green)		The CP is sending/receiving over Industrial Ethernet. Note: PROFINET IO services are not signaled here.
X1P1 / X1P2 (green / yellow)		Port has no connection to Industrial Ethernet.
		Existing connection via port to Industrial Ethernet (LINK status).
		LED flashes yellow (constant light green): Port sending / receiving over Industrial Ethernet or PROFINET IO. Note: All received / sent frames are signaled for each specific port including those simply forwarded by the switch.
		There is permanent data transfer at the port via Industrial Ethernet (e.g. PROFINET IO).

## Module identification (PROFINET interface)

### Note

#### Module identification - make the port LEDs flash briefly

With the help of Web diagnostics or the online functions of STEP 7, you can search for and identify the module in the rack. The options for this are as follows:

- In Web diagnostics  
You click the "Flash" button in the update center.
- In STEP 7  
You click the "Flash" button in the "Browse network" dialog

If you click the "Identify" or "Flash" buttons, all the port LEDs of the PROFINET interface flash briefly.







## 5.1 Important notes on using the device

The following safety notices must be adhered to when setting up and operating the device and during all associated work such as installing, connecting, replacing or removing devices.

### 5.1.1 Notices on use in hazardous areas

 <b>WARNING</b>
The device may only be operated in an environment with pollution degree 1 or 2 as described in EN/IEC 60664-1, GB/T 16935.1.

 <b>WARNING</b>
<b>EXPLOSION HAZARD</b>
You may only connect or disconnect cables carrying electricity when the power supply is switched off or when the device is in an area without inflammable gas concentrations.

### 5.1.2 Notes on use in hazardous areas according to ATEX / IECEx / UKEX

 <b>WARNING</b>
<b>Requirements for the cabinet</b>
To comply with EU Directive 2014/34 EU (ATEX 114), UK Regulation SI 2016/1107 or the conditions of IECEx or CCC-Ex, the housing or cabinet must meet the requirements of at least IP54 (according to EN/IEC 60529, GB/T 4208) in compliance with EN IEC/IEC 60079-7, GB 3836.8.

5.1 Important notes on using the device

 **WARNING**

**Suitable cables at high ambient temperatures in hazardous area**

Use heat-resistant cables with an ambient temperature  $\geq 60\text{ }^{\circ}\text{C}$ ; these cables must be rated for an ambient temperature that is at least  $20\text{ }^{\circ}\text{C}$  higher. The cable entries used on the housing must comply with the IP degree of protection required by EN IEC 60079-0 / GB 3836.1.

 **WARNING**

**Transient overvoltages**

Take measures to prevent transient overvoltages of more than 40% of the rated voltage (or more than 119 V). This is the case if you only operate devices with SELV (safety extra-low voltage).

**5.1.3 Notes on use in hazardous areas according to UL HazLoc / FM**

This equipment is suitable for use in Class I, Division 2, Groups A, B, C and D or non-hazardous locations only.

This equipment is suitable for use in Class I, Zone 2, Group IIC or non-hazardous locations only.

 **WARNING**

**EXPLOSION HAZARD**

Replacing components may impair suitability for Class 1, Division 2 or Zone 2.

 **WARNING**

When used in hazardous environments corresponding to Class I, Division 2 or Class I, Zone 2, the device must be installed in a cabinet or a suitable enclosure.

 **WARNING**

If the device is installed in a cabinet, the inner temperature of the cabinet corresponds to the ambient temperature of the device.

 **WARNING**

**EXPLOSION HAZARD**

The equipment is intended to be installed within an ultimate enclosure. The inner service temperature of the enclosure corresponds to the ambient temperature of the module. Use installation wiring connections with admitted maximum operating temperature of at least 30 °C higher than maximum ambient temperature.

## 5.2 Installation, removal and repairs in hazardous areas

 **WARNING**

**Impermissible accessories and spare parts**

Risk of explosion in hazardous areas

- Only use original accessories and original spare parts.
- Observe all relevant installation and safety instructions described in the manuals for the device or supplied with the accessories or spare parts.

 **WARNING**

**Unsuitable cables or connectors**

Risk of explosion in hazardous areas

- Only use connectors that meet the requirements of the relevant type of protection.
- If necessary, tighten the connector screw connections, device fastening screws, grounding screws, etc. according to the specified torques.
- Close unused cable openings for electrical connections.
- Check the cables for a tight fit after installation.

 **WARNING**

**Improper installation of shielded cables**

There is a risk of explosion due to equalizing currents between the hazardous area and the non-hazardous area.

- Ground shielded cables that cross hazardous areas at one end only.
- Lay a potential equalization conductor when grounding at both ends.

 **WARNING**

**Lack of equipotential bonding**

If there is no equipotential bonding in hazardous areas, there is a risk of explosion due to equalizing current or ignition sparks.

- Ensure that equipotential bonding is available for the device.

 **WARNING**

**Unprotected cable ends**

There is a risk of explosion due to unprotected cable ends in hazardous areas.

- Protect unused cable ends according to IEC/EN 60079-14.

 **WARNING**

**Insufficient isolation of intrinsically safe and non-intrinsically safe circuits**

Risk of explosion in hazardous areas

- When connecting intrinsically safe and non-intrinsically safe circuits, ensure that the galvanic isolation is performed properly in compliance with local regulations (e.g. IEC 60079-14).
- Observe the device approvals applicable for your country.

 **WARNING**

**Unauthorized repair of devices in explosion-proof design**

Risk of explosion in hazardous areas

- Repair work may only be performed by personnel authorized by Siemens.

## 5.3 Installing and connecting up

**NOTICE**

**Improper mounting**

Improper mounting may damage the device or impair its operation.

- Before mounting the device, always ensure that there is no visible damage to the device.
- Mount the device using suitable tools. Observe the information in the respective section about mounting.

**⚠ WARNING****Open equipment**

The devices are "open equipment" acc. to the standard IEC 61010-2-201 or UL 61010-2-201 / CSA C22.2 No. 61010-2-201. To fulfill requirements for safe operation with regard to mechanical stability, flame retardation, stability, and protection against contact, the following alternative types of installation are specified:

- Installation in a suitable cabinet.
- Installation in a suitable enclosure.
- Installation in a suitably equipped, enclosed control room.

**⚠ WARNING****Power supply**

The device is designed for operation with a directly connectable safety extra low voltage (SELV) from a limited power source (LPS).

The power supply therefore needs to meet at least one of the following conditions:

- Only safety extra low voltage (SELV) with limited power source (LPS) complying with IEC 60950-1 / EN 60950-1 / VDE 0805-1 or IEC 62368-1 / EN 62368-1 / VDE 62368-1 may be connected to the power supply terminals.
- The power supply unit for the device must meet NEC Class 2 according to the National Electrical Code (r) (ANSI / NFPA 70).

If the equipment is connected to a redundant power supply (two separate power supplies), both must meet these requirements.

**Note****Pulling/plugging**

Pulling/plugging the CP when the power is on is not permitted.

You should also remember that by removing a module from the rack, all modules on the other side of it will be disconnected from the CPU.

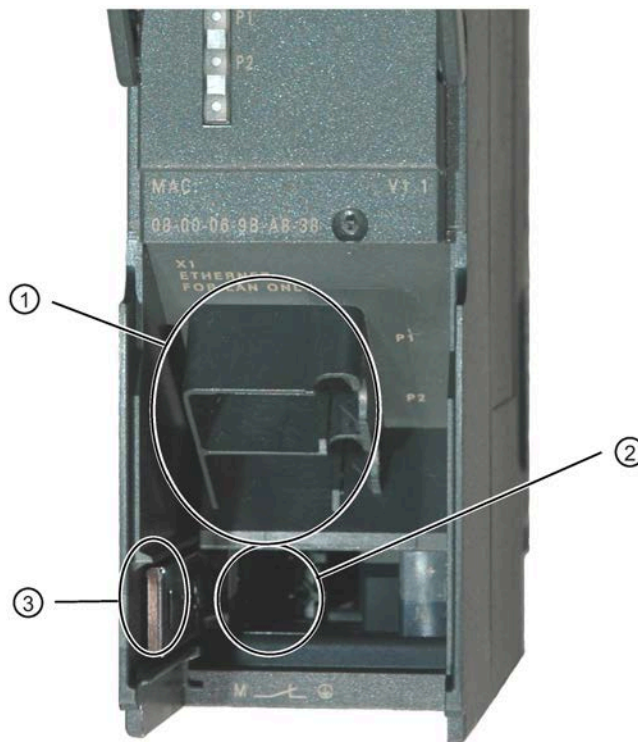

Legend:

- 1) Attachment to Industrial Ethernet (PROFINET interface): 2 x 8pin RJ45 jack
- 2) Connecting the power supply
- 3) Slider for setting the chassis ground connection

Figure 5-1 Connectors of the CP

## Ground/chassis ground concept

---

### Note

Note the instructions regarding the grounding and chassis ground concept in the SIMATIC S7 installation guides; see "SIMATIC S7 Programmable Controller S7300 - Installation and Hardware: Installation Manual": /12/ (Page 76)".

---

Behind the hinged panel on the left of the device, you will see a slider with which you can connect or disconnect the chassis ground of the 24V power supply with reference ground.

- Slider pushed in: Chassis ground and reference ground are connected (caution: you can feel the slider lock into position).
- Slider pulled out: There is no connection between chassis ground and reference ground.

When shipped: Slider pushed in

Use a screwdriver to set the slider.

## Installing and connecting up

### NOTICE

#### Ensuring ventilation

During installation, make sure that the upper and lower ventilation slits of the module are not obstructed and good ventilation is possible.

1. Install the CP on the S7 standard rail.

Slots 4 to 11 are permitted for the CP in racks 0 to 3 (connected by IM 360/361). Follow the steps described in detail in /12/ (Page 76) in the sections dealing with installation and wiring.

### Note

#### No installation in an expansion rack

The CP cannot be operated in an expansion rack that is connected via the IM 365. Reason: The required communication bus is not connected to the expansion rack via the IM 365.

2. Establish the connection via the enclosed bus connector to the backplane bus.
3. Connect the CP to the power supply.

Follow the steps as described in detail in /12/ (Page 76) when wiring between the power supply and the CPU.

### NOTICE

#### Same power supply

The CPU, CP and IM (if one exists) must be connected to the same power supply.  
Only wire up the S7300 / C7300 with the power switched off!

4. Connect the CP to Industrial Ethernet.

An Ethernet cable can also be inserted and removed with the power supply on.

The remaining steps in commissioning involve downloading the configuration data.

## Downloading and addressing

You can connect the PG as follows when downloading the configuration data:

- Via MPI
- Via Industrial Ethernet

For further details, refer to the general Part A of this manual.

- Addressing the first time (IP address assignment / node initialization)
- To download the defined configuration

The PG / PC requires a LAN attachment, for example via a CP 1613 or CP 1411 and must have the necessary software (for example the S71613 package or SOFTNET IE). The TCP/IP protocol must be installed. The protocol used must then be applied to the S7ONLINE access point.

## **Diagnostics**

Use the diagnostic functions during commissioning and to analyze problems. The following options are available:

- The LED displays on the CP
- Hardware diagnostics and troubleshooting with STEP 7
- Communication diagnostics with STEP 7 / NCM Diagnostics
- Static information using HW Config
- Web diagnostics
- If applicable, evaluation of the alarm block FB 54 in the user program
- Queries via SNMP



## Connecting interface X1 to Industrial Ethernet

1. Connect the CP to Industrial Ethernet via one of the RJ45 jacks.
2. Where necessary, connect another component to the remaining free RJ45 jack.

---

### Note

#### Autocrossing mechanism - effects on the connectors

For small local area networks or for attaching several Ethernet devices, a 2port switch has been integrated on the PROFINET interface of the CP.

With the autocrossing mechanism integrated in the switch, it is possible to use a standard cable to connect the PG/PC. A crossover cable is not necessary.

Please note the following points:

- Manual configuration  
If a port is set to manual configuration and autonegotiation is disabled, the autocrossing mechanism is also disabled for this port. Which cable you need to use depends on the partner device (network component or end device).  
In the factory, the ports are set for automatic configuration.  
For more information, refer to section Network settings (Page 47)
  - Connecting switches  
If you connect further switches, make sure that no ring is formed in the network.
- 

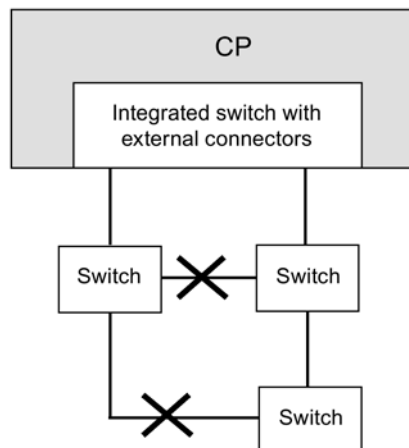

Figure 5-2 Connecting switches

---

### Note

#### MRP configuration

With an MRP configuration, keep to the setup guidelines for MRP.

You will find examples of network attachments in the general Part A of this manual, see /1/ (Page 73).

---

## 5.4 Disassembly

 **WARNING**

**Improper disassembly**

Improper disassembly may result in a risk of explosion in hazardous areas.

For proper disassembly, observe the following:

- Before starting work, ensure that the electricity is switched off.
- Secure remaining connections so that no damage can occur as a result of disassembly if the system is accidentally started up.

# Configuration and operation

<b>NOTICE</b>
The front panel must be kept closed during operation.

## 6.1 Security recommendations

Keep to the following security recommendations to prevent unauthorized access to the system.

### General

- You should make regular checks to make sure that the device meets these recommendations and other internal security guidelines if applicable.
- Evaluate your plant as a whole in terms of security. Use a cell protection concept with suitable products.
- Do not connect the device directly to the Internet. Operate the device within a protected network area.
- Check the Siemens website regularly for the latest information.
  - You can find information on Industrial Security here:  
Link: (<http://www.siemens.com/industrialsecurity>)
  - You can find information on security in industrial communication here:  
Link: (<https://support.industry.siemens.com/cs/ww/en/view/92651441>)
- Keep the firmware up to date. Check regularly for security updates of the firmware and use them.

Information regarding product news and new firmware versions is available at the following address:

Link: (<https://support.industry.siemens.com/cs/ww/en/ps/15344/dl>)

### Physical access

Restrict physical access to the device to qualified personnel.

### Network attachment

Do not connect the PC directly to the Internet. If a connection from the CP to the Internet is required, arrange for suitable protection before the CP, for example a SCALANCE S with firewall.

## Security functions of the product

Use the options for security settings in the configuration of the product. These includes among others:

- Protection levels  
Configure access to the CPU under "Protection".
- Leave access to the Web server of the CPU (CPU configuration) and to the Web server of the CP disabled.
- Protection of the passwords for access to program blocks  
Protect the passwords stored in data blocks for the program blocks from being viewed. You will find information on the procedure in the STEP 7 information system under the keyword "Know-how protection".

## Passwords

- Define rules for the use of devices and assignment of passwords.
- Regularly update the passwords to increase security.
- Only use passwords with a high password strength. Avoid weak passwords for example "password1", "123456789" or similar.
- Make sure that all passwords are protected and inaccessible to unauthorized personnel.  
See also the preceding section for information on this.
- Do not use one password for different users and systems.

## Protocols

### Secure and non-secure protocols

- Only activate protocols that you require to use the system.
- Use secure protocols when access to the device is not prevented by physical protection measures.
- Deactivate DHCP at interfaces to public networks such as the Internet, for example, to prevent IP spoofing.

### Table: Meaning of the column titles and entries

The following table provides you with an overview of the open ports on this device.

- **Protocol / function**  
Protocols that the device supports.
- **Port number (protocol)**  
Port number assigned to the protocol.

- **Default of the port**
  - Open  
The port is open at the start of the configuration.
  - Closed  
The port is closed at the start of the configuration.
- **Port status**
  - Open  
The port is always open and cannot be closed.
  - Open after configuration  
The port is open if it has been configured.
  - Open (login, when configured)  
As default the port is open. After configuring the port, the communications partner needs to log in.
  - Open with block call  
The port is only opened when a suitable program block is called.
- **Authentication**  
Specifies whether or not the protocol authenticates the communications partner during access.

Protocol / function	Port number (protocol)	Default of the port	Port status	Authentication
<b>S7 and online connections</b>	102 (TCP)	Open	Open after configuration	No
<b>HTTP</b>	80 (TCP)	Closed	Open after configuration	No
<b>SNMP</b>	161 (UDP)	Open	Open after configuration	Yes (with SNMPv3)

### Ports of communication partners and routers

Make sure that you enable the required client ports in the corresponding firewall on the communications partners and in intermediary routers.

These can be:

- NTP / 123 (UDP)
- DNS / 53 (UDP)
- DHCP / 67, 68 (UDP)

## 6.2 Project engineering

### Project engineering

To set up the CP for communication services, read the information on configuring in the sections Project engineering (Page 25) and Replacing a module without a programming device (Page 63). For detailed information on configuration, refer to Part A of this manual, see References /1/ (Page 73).

## 6.3 Controlling the mode

You have the option of changing the mode of the CP between RUN and STOP using the STEP 7 configuration software (PLC > Accessible Nodes).

### Change from STOP to RUN

The CP loads configured and/or downloaded data into the work memory and then changes to RUN mode.

### Change from RUN to STOP

The CP changes to STOP - transitional phase with LED display "Stopping (RUN → STOP)".

- Established connections of the open communications services (see also section Communication services (Page 13)) are terminated.
- The following functions are disabled:
  - PROFINET IO
  - Time-of-day synchronization
- The following functions remain enabled:
  - Downloading the configuration data and diagnostics of the CP
  - System connections for configuration, diagnostics and PG channel routing still exist.
  - Web diagnostics (HTTP access)
  - Routing function

### Module access protection

The configurable module access protection has the following effects on the functions described here:

- Module access protection: Not locked  
The functions cannot be executed.
- Module access protection: Status-dependent  
With this setting, it is only possible to access the CP when the CPU is in STOP mode.

## 6.4 Network settings

The configuration of the network settings "Transmission medium / Duplex" is made in the properties dialog of the port of the interface in the "Options" tab.

Row "X1P1": Properties of port 1 of the PROFINET interface

Row "X1P2": Properties of port 2 of the PROFINET interface

### Automatic setting or individual network settings

As default, the CP is configured for automatic detection (autosensing / autonegotiation / autocrossing).

---

#### Note

In normal situations, the basic setting ensures troublefree communication. You should only change this in exceptional situations.

---

If you create a manual configuration for the CP, the automatic negotiation of the network settings (autonegotiation) is no longer effective. If, on the other hand, the communication partner works with autonegotiation, no communication will be established.

Only use manual configuration when the communication partner works with the same manually set configuration.

### Autocrossing mechanism

The automatic setting also includes an "autocrossing" mechanism. With autocrossing, you can connect network components and end devices using either crossover or straight-through cables.

### STEP 7 special diagnostics and Web diagnostics display the network setting

Diagnostics of the port settings for the CP described here is possible using the entries in the diagnostics buffer using Web diagnostics, SNMP, STEP 7 diagnostics, and the LED displays.

You will find information on the currently used network settings in STEP 7 as follows:

- In STEP 7 special diagnostics under the diagnostics object "Industrial Ethernet" in the "Network Connection" group box
- in STEP 7 with the menu command "PLC > Module Information"
- In Web diagnostics

**Further notes:**

- Autocrossover

If you disable the "Automatic setting" option, autocrossing is disabled; which cable you then use depends on the integration of the CP (network component or end device).

- 10/100 Mbps network components without "autonegotiation"

If you use 10/100 Mbps network components that do not support "Autonegotiation", it is possible that you will have to set the mode manually in the CP configuration in STEP 7. As default, the CP is configured for automatic detection.

- Forcing a specific network setting instead of "Autonegotiation"

If your application requires a fixed network setting instead of "Autonegotiation", both partner devices must have the same setting.

- No reaction to Autonegotiation query with manual configuration

Remember that if you configure the CP manually, it will not react to an autonegotiation query! As a result, a connected partner will not be able to make the required network setting and communication will not be established.

Example:

If the CP is set to "100 Mbps full duplex", a CP connected as partner will set itself to "100 Mbps half duplex". Reason: Due to the fixed setting, no autonegotiation response is possible; the connected partner recognizes the 100 Mbps with autosensing but nevertheless remains in half duplex.

- Recommendation: Change "individual network settings" only over MPI

If you modify the LAN settings in the properties dialog of the CP in the "Port Parameters" tab, these changes will be adopted by the CP and activated when the configuration data is downloaded to the CP. In some situations, the device may then no longer be obtainable over Ethernet.

We therefore recommend that you download configuration data to the S7 station over an MPI connection if you change this setting.

If you download the configuration data over the LAN interface then, depending on the selected setting, it is possible that the current download will not be completed due to the changes to the configuration taking immediate effect and an inconsistent configuration is reported.

Example:

The download is started initially with the setting TP/ITP at 10 Mbps half duplex. If the "Individual network setting" is now changed to 100 Mbps full duplex, the download cannot be completed.



## 6.5 Influence of MPI on connections via Industrial Ethernet

### Adding/removing MPI nodes

If a station on the MPI bus is added or removed, for example because a service PG has been connected or disconnected, it is possible that active communication connections on the communications bus are aborted. This has the following effects on the communication connections on Industrial Ethernet:

- All S7 connections are temporarily aborted.

Exceptions: This does not apply when using CPUs with a separate communication bus, for example:

CPU 318-2, CPU 317-2 PN/DP, CPU 319-3 PN/DP, CPU 315-2 PN/DP, CPU 315F-2 PN/DP, CPU 317-2 DP, CPU 317T-2 DP, CPU 317F-2 DP, CPU 317F-2 PN/DP, CPU 319-3 PN/DP

- FETCH/WRITE connections are temporarily aborted.

On the FC interface in the user program, the condition codes made up of the DONE, ERROR and STATUS parameters must be evaluated in FC11 / FC12.

## 6.6 PROFINET IO when operating other services at the same time

### Sporadically used services

Note the following if you are using functions alongside PROFINET IO that affect the configuration or the operating status, for example IP\_CONFIG (FB55), Primary Setup Tool / SINEC PNI, STEP 7 special diagnostics:

---

#### Note

The functions listed above can influence the flow in PROFINET IO so that an interruption of cyclic IO data exchange of the PROFINET IO devices lasting several seconds may occur.

---

## 6.7 Effects of multicast communication on RT communication

---

### Note

If PROFINET IO RT communication is operated at the same time as broadcast (BC) or multicast (MC) in an industrial Ethernet subnet, RT frames can be delayed by long BC frames or MC frames.

Among other things, these frames can be generated by the communications FCs AG\_SEND or AG\_RECV.

With certain constellations, this can lead to a PROFINET RT communication abort. The factors that influence this are the switch configurations ("switch depth"), the update time and the MC/BC frame lengths.

---

You will find further information about the influencing factors as well as possible solutions in:

Link: (<http://support.automation.siemens.com/WW/view/en/29104898>)

## 6.8 IP configuration

### 6.8.1 Detection of double IP addressing in the network

To save you time-consuming troubleshooting in the network, the CP detects double addressing in the network.

The reaction of the CP when double addressing is detected varies as follows:

- CP during startup

When the CP starts up (following a power down or after assigning an Ethernet address), a query for its own IP address is sent into the network. If a response is sent in reply, the CP does not start up! The error is indicated by the LEDs ("Stopped (STOP) with error" + "BF" LED is displayed) and an entry is made in the internal diagnostics buffer.

The CP remains in STOP mode.

When you eliminate the cause by removing the device with the same IP address or by changing its address, you then need to restart the CP.

- CP in RUN mode

If a double IP address is detected, the CP also reports this via the LED (BF) and generates an entry in the diagnostics buffer.

The CP remains in RUN mode.

If the conflict is eliminated on another component, the "BF" LED goes off again.

## 6.8.2 Obtain IP address via DHCP: CP STOP on expiry of the lease

If you have configured "Obtain IP address from a DHCP server", when the CP starts up, it is assigned a valid IP address by the DHCP server for a restricted time (period of the lease).

---

### Note

#### STOP on expiry of the lease

The CP changes to STOP and loses the previously assigned IP address if the DHCP server does not extend it before expiry of the lease. All communication connections are terminated.

---

## 6.9 Media redundancy

You can use the CP in a ring topology with media redundancy. The CP can only be a redundancy client.

For more detailed information on configuration, refer to the online help of the "Media redundancy" tab and Part A of the manual, see /1/ (Page 73).

## 6.10 Timeofday synchronization

### General rules

The CP supports the two modes explained below for timeofday synchronization:

- SIMATIC mode
- NTP mode (NTP: Network Time Protocol)

No automatic changeover to daylight saving time is defined in NTP. As a result, you may need to implement this changeover using a program application.

### Project engineering

For more detailed information on configuration, refer to the online help of the "Time-of-day synchronization" parameter group and in Part A of the manual /1/ (Page 73).

## 6.11 SNMP agent

### SNMP (Simple Network Management Protocol)

SNMP is a protocol for managing networks. To transmit data, SNMP uses the connectionless UDP protocol.

The information on the properties of SNMP-compliant devices is entered in MIB files (MIB = Management Information Base).

The CP supports data queries using SNMP in version 1. It delivers the content of certain MIB objects according to the standard MIB II, LLDP MIB, Automation System MIB and MRP Monitoring MIB.

### MIB file and SNMP profile file

You will find the MIB file and the SNMP profile file of the module in the STEP 7 installation in the folders "S7DATA" > "snmp" under the name of the module.

### Further information

For more detailed information on working with MIB files, refer to the documentation of the SNMP client you are using (example of an SNMP client: SNMP OPC server from SIMATIC NET).

For more information on SNMP, refer to the SNMP manual:

Link: (<https://support.industry.siemens.com/cs/ww/en/ps/15392/man>)

### Supported MIBs

The CP supports the following groups of MIB objects of the standard MIB II according to RFC1213:

- System
- Interfaces
- Address Translation (AT)
- IP
- ICMP
- TCP
- UDP
- SNMP

The other groups of the MIB II standard are not supported:

- EGP
- Transmission

The CP also supports the LLDP MIB according to IEEE 802.1AB, the PROFINET expansions of the LLDP MIB (see also IEC 61158106), the Automation System MIB and the MRP Monitoring MIB.

Exceptions / restrictions:

- Write access is permitted only for the following MIB objects of the system group:

- sysContact
- sysLocation
- sysName

A set sysName is sent as the host name using DHCP option 12 to the DHCP server to register with a DNS server.

For all other MIB objects / MIB object groups, only read access is possible for security reasons.

- Traps are not supported by the CP.

### "Interfaces" MIB group

This group returns status information about the CP interfaces. The MIB objects of the ifTable provide the status information of the interfaces. The "ifIndex" object identifier is assigned to the CP interfaces as follows:

Table 6-1 Assignment of ifIndex

ifIndex	Type of interface
1-2	Port 1-2
3	Internal CP interface

### Access permissions using community name

The CP uses the following community names to control the access rights in the SNMP agent:

Table 6-2 Access rights in the SNMP agent

Type of access	Community name *)
Read access	public
Read and write access	private

\*) Note the use of lowercase letters!

### MIB files for your SNMP tools

If you use an SNMP tool, you will find the MIB files relevant to the CP in the STEP 7 installation in the following folder:

<Drive>\<Installation folder>\Siemens\Step7\S7DATA\snmp\mib

For the Automation System MIB, for example, these are the following files:

- automationPS.mib
- automationSmi.mib
- automationSystem.mib
- automationTC.mib

## 6.12 Possible security gaps on standard IT interfaces: preventing unauthorized access

With various SIMATIC NET components, such as switches, a wide range of parameter assignment and diagnostics functions (for example, Web servers, network management) are available using open protocols and interfaces. The possibility of unauthorized misuse of these open protocols and interfaces by third parties, for example to manipulate data, cannot be entirely excluded.

When using the functions listed above and these open interfaces and protocols (for example, SNMP, HTTP), you should take suitable security measures to prevent unauthorized access to the components and the network particularly from within the WAN/Internet.

---

### Note

We expressly point out that automation networks must be isolated from the rest of the company network by suitable gateways (for example using tried and tested firewall systems). We do not accept any liability whatsoever, whatever the legal justification, for damage resulting from nonadherence to this notice.

---

If you have questions on the use of firewall systems and IT security, please contact your local Siemens office or representative. You will find the address in the SIMATIC catalog IK PI or on the Internet at the following address:

(<http://www.automation.siemens.com/partner/guisearch.asp>)

## 6.13 Programmed communication connections

### 6.13.1 Programmed communication connections with FB55 IP\_CONFIG

#### Downloading the configuration using FB55 IP\_CONFIG

IP\_CONFIG allows programcontrolled transfer of the configuration data.

---

**Note**

If the CP is in PG STOP mode and the configuration is downloaded using IP\_CONFIG, the CP then changes automatically to RUN.

---

### 6.13.2 Programmed communications connections - assigning parameters to the ports

The CP supports the following settings when assigning parameters to the ports in the parameter block for TCP connections and UDP connections:

- SUB\_LOC\_PORT parameter  
The port can be specified as an option when the connection is established actively.
- SUB\_REM\_PORT parameter  
The port can be specified as an option when the connection is established passively.

## 6.14 Permitted length of ICMP packets

### Permitted length of ICMP packets

Pings with a packet size of more than 1000 bytes are evaluated as an attack and filtered by the CP. This response is intentional and improves the robustness of the CP in an industrial environment.







<b>! CAUTION</b>
<b>Hot surfaces</b> Risk of burns during maintenance work on parts with a surface temperature above 70 °C (158 °F). <ul style="list-style-type: none"><li>• Take appropriate protective measures, for example, wear protective gloves.</li><li>• Once maintenance work is complete, restore the touch protection measures.</li></ul>

<b>! WARNING</b>
<b>Cleaning the housing</b> <ul style="list-style-type: none"><li>• <b>In hazardous areas</b> Only clean the outer parts of the housing with a damp, but not wet, cloth.</li><li>• <b>In non-hazardous areas</b> Only clean the outer parts of the housing with a dry cloth.</li></ul> Do not use any liquids or solvents.

## 7.1 Diagnostics options

### Overview of the Diagnostics options

The following diagnostics options are available:

- **LEDs of the module**  
For information on the LED displays, refer to the section LEDs (Page 29).
- **Web diagnostics**  
For information on Web diagnostics using HTTP, refer to the section The CP as Web server (Page 15).

- **STEP 7 V5.5**
  - Hardware diagnostics and troubleshooting
  - Communication diagnostics with special diagnostics

- **STEP 7 Professional**

In the "Diagnostics" tab in the Inspector window, you will see the following information:

- Entries in the diagnostics buffer of the CPU
- Information on the online status

In the "Online > Online and diagnostics" menu, you obtain the static information about the module:

- General information on the module
- Diagnostics status
- Information on the interfaces
- Information relating to special diagnostics (folder "Functions" > Special diagnostics)

You will find further information on the diagnostics functions of STEP 7 in the STEP 7 information system.

## 7.2 Memory reset / reset to factory defaults

If the CP was configured with the "Status-dependent" protection level, the following two functions are available only when the CPU is in STOP mode. You will find a setting in the properties dialog of STEP 7 > "Options" > Module access protection tab.

## Available functions

The CP has a twolevel function available for resetting memory:

- Memory reset

Following this memory reset, the CP retains the preset MAC address and the retentive parameters. The CP is therefore immediately ready for downloads using the IP address.

The retentive parameters include:

- IP address, subnet mask and, if applicable, router address
- LAN settings

- Reset to factory settings

After resetting, the CP only contains the default MAC address (as shipped).

---

### Note

The functions for memory reset and resetting to defaults described here do not change the configuration data on the CPU!

If you subsequently upload the configuration data from the CPU to a PG you will always obtain the configuration data that was previously on the CP (with parameters, connections, IP address).

---

## How to use the function

You can start the memory reset functions in STEP 7.

- Memory reset

- In STEP 7 V5.5 with the menu command "PLC" > "Clear/Reset"
- In STEP 7 special diagnostics with the "Operating Mode" > "Clear/Reset Module" menu command
- In STEP 7 Professional V11 with STEP 7 special diagnostics

- Reset to factory settings

- In STEP 7 V5.5 with the menu command "PLC" > "Edit Ethernet Node..." > Select CP > "OK" > "Reset to Factory Defaults"
- In STEP 7 special diagnostics with the "Operating Mode" > "Reset to Factory Settings" menu command
- In STEP 7 Professional V11 with "Online > Online & Diagnostics > Functions > Reset to Factory Settings"

## Behavior after a memory reset

The CPU in the S7 station does not recognize that the CP memory was reset. The CP therefore changes to the "Stopped (STOP) with error" state (see LEDs (Page 29)).

The configuration data must then be reloaded. The download of the configuration data can be initiated by cycling the power supply (OFF → ON).

## 7.3 Loading new firmware

### Options for a firmware update

The following alternative methods can be used to download new firmware to a SIMATIC NET CP:

- Using the firmware loader supplied with STEP 7

Requirement for downloading:

- To download firmware, you require an Industrial Ethernet CP module in the PG/PC (for example, CP 1613) or a normal Ethernet module with the "Softnet" software package.
- The S7ONLINE interface must be set to the "ISO - Industrial Ethernet" protocol. It is not possible to download using TCP/IP (and therefore not to other networks).

- Via the update center in the Web diagnostics of the CP

With this method, the CP remains in RUN mode.

You can reach the update center using Web diagnostics.

Requirement: The option "Firmware download via Web" is selected in the configuration.

Both options for loading the firmware are described in the manual Part A, see /1/ (Page 73).

### LED displays when loading a firmware file

The LED combinations when loading a firmware file using the STEP 7 firmware loader can be found in the section LEDs (Page 29).

When loading a firmware file using the update center in Web diagnostics, the LEDs of the CP remain unchanged.

### If the loading with the firmware loader is interrupted, you should react as follows:

Disturbances or collisions on the network can lead to packets being lost. In such cases, this can lead to an interruption of the firmware download. The firmware loader then signals a timeout or negative response from the module being loaded.

In this case, turn the station off and on again and repeat the download.

## 7.4 Replacing a module

---

### Note

#### Recommendation to reset address data if the use of the CP is changed

The following data is stored permanently on the CP:

- IP parameters when using DHCP

If the CP has already been operated in your plant and you want to use it at a different location in the plant, it starts up with the permanently configured parameters.

If the CP has been used previously in your plant or has been repaired, delete all stored data by resetting to the factory settings.

---

### 7.4.1 Replacing older modules

#### Distinction

When replacing existing modules with the module described here, the following variants must be distinguished:

- **Replacing a module**

Describes the situation when an existing module can be replaced with a new module simply by pulling/plugging without changing the configuration.

- **Upgrading**

(module replacement with compatible functions)

Describes the situation when the module described here can be used instead of an older module as long as adaptations are made to the configuration. Here, the previously used CP needs to be replaced in the configuration by the new CP.

Unless otherwise specified, the range of functions of the older module continues to be supported.

You can also upgrade modules listed in "Module replacement". This is necessary when new characteristics that were not available in the previously used module are required.

## 7.4.2 module replacement / upgrading

### Replacing a module

The CP 343-1 Lean described here (6GK7 343-1CX10-0XE0 firmware version 3.0) can be used as a replacement for the following predecessor products:

- CP 343-1 Lean (6GK7 343-1CX00-0XE0)

When replacing a CP 343-1 Lean (CX00) with a CP 343-1 Lean (CX10) and a STEP 7 version < V5.4, all the previous functions remain available. Any port settings made for Ethernet are adopted for port 1.

The additional second RJ-45 port is also available in the "Automatic setting" mode.

- CP 343-1 Lean (6GK7 343-1CX10-0XE0, firmware version V1.0, V2.x)

All previous functions remain available. In addition, the new functions compared with the firmware version of the previous product are also available.

### Upgrading

The following predecessor products can be upgraded on the CP 343-1 Lean (6GK7 343-1CX10-0XE0) described here.

Refer to modules in "Replacing modules".

### Interface in the user program

---

#### Note

You should always use the latest block versions for new user programs. You will find information on the current block versions and the current blocks for downloading on the Internet under:

Link: (<https://support.industry.siemens.com/cs/ww/en/ps/15342/dl>)

---

## Module replacement

Please follow the procedure below when replacing an older module with the module described here:

Table 7- 1 Replacing an older module

Originally configured module	Configuration procedure
6GK7 343-1CX00-0XE0	<p><b>Case a: Configuration unchanged / module replacement</b> If you have no requirements beyond what you had with the previous CP (for example PROFINET IO mode), you do not need to make changes in the configuration.</p> <p><b>Case b: Adapted configuration / upgrade</b> If you want to use the extended options of the new CP, follow the steps below:</p> <ol style="list-style-type: none"> <li>1. Replace the previously configured CP with the new module in STEP 7 / HW Config. You will find this in the hardware catalog.</li> <li>2. Expand the configuration according to your requirements, for example by enabling the CP for PROFINET IO device mode.</li> <li>3. Save, compile and download the configuration data to the CPU again.</li> </ol>

### 7.4.3 Replacing a module without a programming device

#### Replacing the CP with the same or a previous module

- Replacing with the same module

The configuration data of the CP is stored on the CPU. Replacing the CP with a module of the same type (identical order number) is therefore possible without a PG.

- Replacing with a previous module

For information on replacing previous modules, refer to the information in section module replacement / upgrading (Page 62).

### Module replacement: Special feature of IP address assignment from a DHCP server

During configuration of the CP you can specify the IP configuration in the properties dialog; one option is to obtain the IP address from a DHCP server.

---

#### Note

When replacing modules, please remember that the factoryset MAC address of the new module is different from the previous module. When the factoryset MAC address of the new module is sent to the DHCP server, this will return either a different or possibly no IP address.

Ideally, you should therefore configure IP as follows:

Always configure a client ID if you want to obtain the same IP address from the DHCP server after replacing the module.

---



# Technical specifications

Table 8- 1 Technical specifications

<b>Technical specifications</b>		
<b>Attachment to Industrial Ethernet</b>		
Number	1 x PROFINET interface with 2port switch	
Execution	Connector	2 x RJ-45 jacks
	Transmission rate	10 / 100 Mbps
		When working with PROFINET IO and cyclic transfer, the transmission speed of 100 Mbps full duplex is mandatory.
	Aging time	5 minutes
	Special features of the X1P1R and X1P2R ports	Integration in ring topology / MRP possible
<b>Electrical data</b>		
Supply voltage	External power supply	24 VDC
	Permitted range	+20.4 V to +28.8 V
	From backplane bus	5 VDC
Current consumption	From external power supply	200 mA maximum
	From backplane bus	200 mA maximum
Effective power loss	5.8 W	
<b>Permitted ambient conditions</b>		
Ambient temperature	During operation with the rack installed horizontally	0 °C to +60 °C
	During operation with the rack installed vertically	0 °C to +40 °C
	During storage	-40 °C to +70 °C
	During transportation	-40 °C to +70 °C
Relative humidity	During operation	≤ 95 % at 25 °C, no condensation
Operating altitude	During operation	≤ 2,000 m above sea level
Contaminant concentration	Acc. to ISA-S71.04 severity level G1, G2, G3	
<b>Design, dimensions and weight</b>		
Module format	Compact module for S7-300, single width	
Degree of protection	IP20	
Weight	Approx. 220 g	
Dimensions (W x H x D)	40 x 125 x 120 mm	
Installation options	Mounting in an S7-300 rack	
<b>Product functions *</b>		

\* You will find the product functions in the section Properties / services (Page 11).

For further data, refer to section Performance data (Page 17)

In addition to this, all the information in the "SIMATIC S7-300 Automation System Module Data" see /12/ (Page 76) in the section "General Technical Specifications" on the topics listed below applies to the CP:

- Electromagnetic compatibility
- Transportation/storage conditions
- Mechanical and climatic environmental conditions
- Information on insulation checks, protection class and degree of protection

## Approvals

### Approvals issued

---

**Note****Issued approvals on the type plate of the device**

The specified approvals apply only when the corresponding mark is printed on the product. You can check which of the following approvals have been granted for your product by the markings on the type plate.

Approvals for shipbuilding are not printed on the device type plate.

---

### Current approvals on the Internet

You will find the current approvals for the product on the Internet pages of Siemens Industry Online Support at the following link:

(<https://support.industry.siemens.com/cs/ww/en/ps/15345/cert>)

### Documents on the Internet

You will find the declarations of conformity listed below and certificates of the product on the Internet at the following address:

Link: (<https://support.industry.siemens.com/cs/ww/en/ps/15344/cert>)

You can see the current versions of the standards in the relevant certificate, which you will find on the Internet at the address specified above.

### Address for declarations of conformity

The EU and the UK declarations of conformity are available to all responsible authorities at:

Siemens Aktiengesellschaft  
Digital Industries  
P.O. Box 48 48  
90026 Nuremberg  
Germany

## EU Declaration of Conformity



The product meets the requirements and safety objectives of the following EC directives and it complies with the harmonized European standards (EN) for programmable logic controllers which are published in the official documentation of the European Union:

- **2014/34/EU (ATEX explosion protection directive)**

Directive of the European Parliament and the Council of 26 February 2014 on the approximation of the laws of the Member States concerning equipment and protective systems intended for use in potentially explosive atmospheres, official journal of the EU L96, 29/03/2014, pages. 309-356

- **2014/30/EU (EMC)**

EMC directive of the European Parliament and of the Council of 26 February 2014 on the approximation of the laws of the member states relating to electromagnetic compatibility; official journal of the EU L96, 29/03/2014, pages 79-106

- **2011/65/EU (RoHS)**

Directive of the European Parliament and of the Council of 8 June 2011 on the restriction of the use of certain hazardous substances in electrical and electronic equipment

## UK Declaration of Conformity



Importer UK:

Siemens plc  
Sir William Siemens House  
Princess Road  
Manchester  
M20 2UR

The product meets the requirements of the following directives:

- UKEX Regulations

SI 2016/1107 The Equipment and Protective Systems Intended for Use in Potentially Explosive Atmospheres Regulations 2016, and related amendments

- EMC Regulations

SI 2016/1091 The Electromagnetic Compatibility Regulations 2016

- RoHS Regulations

SI 2012/3032 The Restriction of the Use of Certain Hazardous Substances in Electrical and Electronic Equipment Regulations 2012

**ATEX / IECEx / UKEX / CCC-Ex**

Note the information in the document "Use of subassemblies/modules in a Zone 2 Hazardous Area", which you will find on the Internet at the following address:

Link: (<https://support.industry.siemens.com/cs/ww/en/view/78381013>)

The conditions must be met for safe usage of the product according to the section AUTOHOTSPOT.

 <b>WARNING</b>
<p><b>Observe installation guidelines</b></p> <p>The product meets the requirements if you observe the following during installation and operation:</p> <ul style="list-style-type: none"> <li>• The notes in the section Installation, connection, commissioning, removal (Page 33)</li> <li>• The installation guidelines in the document /12/ (Page 76)</li> </ul>

The product meets the explosion protection requirements outlined below.

**IECEx**

Classification: Ex ec IIC T4 Gc, Certificate no.: IECEx DEK 18.0019X

The product meets the requirements of the standards:

- IEC 60079-0 - Explosive atmospheres - Part 0: Equipment - General requirements
- IEC 60079-7 - Explosive Atmospheres - Part 7: Equipment protection by increased safety 'e'

**ATEX**

Classification: II 3G Ex ec IIC T4 Gc, Certificate no.: DEKRA 18ATEX0027 X

The product meets the requirements of the standards:

- EN IEC 60079-0 - Explosive atmospheres - Part 0: Equipment - General requirements
- EN 60079-7 - Explosive Atmospheres - Part 7: Equipment protection by increased safety 'e'

**UKEX**

Classification: Ex ec IIC T4 Gc, Certificate no.: DEKRA 21UKEX0003 X

The product meets the requirements of the standards:

- EN IEC 60079-0 - Explosive atmospheres - Part 0: Equipment - General requirements
- EN 60079-7 - Explosive Atmospheres - Part 7: Equipment protection by increased safety 'e'

Importer UK: Siemens plc (see above)



### CCC

Classification: Ex na IIC T4 Gc

The product meets the requirements of the following standards:

- GB 3836.1  
Explosive atmospheres - Part 0: Equipment - General requirements
- GB 3836.3  
Explosive atmospheres - Part 3: Equipment protection by increased safety "e"
- GB 3836.8  
Explosive atmospheres - Part 15: Equipment protection by type of protection 'n'

### EMC

The CP meets the requirements of the following directives:

- EU directive 2014/30/EU "Electromagnetic Compatibility" (EMC directive)
- EMC Regulations SI 2016/1091 The Electromagnetic Compatibility Regulations 2016

Applied standards:

- EN 61000-6-2  
Electromagnetic compatibility (EMC) - Part 6-2: Generic standards - Immunity for industrial environments
- EN 61000-6-4  
Electromagnetic compatibility (EMC) - Part 6-4: Generic standards - Emission standard for industrial environments

### RoHS

The CP meets the requirements of the following directives:

- EU directive 2011/65/EU on the restriction of the use of certain hazardous substances in electrical and electronic equipment.
- SI 2012/3032 The Restriction of the Use of Certain Hazardous Substances in Electrical and Electronic Equipment Regulations 2012

Applied standard: EN IEC 63000

### cULus Hazardous (Classified) Locations



Underwriters Laboratories Inc.

cULus Listed 7RA9 IND. CONT. EQ. FOR HAZ. LOC.:

- UL 508 (Industrial Control Equipment)
- UL 1604 (Hazardous Location)
- CSA C22.2 No. 142 (Process Control Equipment)
- CSA C22.2 No. 213 (Hazardous Location)



APPROVED for Use in:

- Cl. 1, Div. 2, GP. A, B, C, D T4A; Ta = 0 °C...60 °C
- Cl. 1, Zone 2, GP. IIC T4; Ta = 0 °C...60 °C

FM



Factory Mutual Research (FM):

Approval Standard Class Number 3611

APPROVED for Use in:

Class I, Division 2, Group A, B, C, D, Temperature Class T4A; Ta = 0 °C...60 °C

Class I, Zone 2, Group IIC, Temperature Class T4; Ta = 0 °C...60 °C

### Note for Australia



AS/NZS 2064 (Class A)

### Note for Korea

KCC-REM-S49-S7300CP





## References

### Finding the SIMATIC NET documentation

- **Siemens Industry Mall**

You will find the order numbers for the Siemens products of relevance here in the Siemens Industry Mall:

Link: (<https://eb.automation.siemens.com/goos/catalog>)

- **Documentation on the Internet**

You will find SIMATIC NET manuals on the Internet pages of Siemens Industry Online Support:

Link: (<http://support.automation.siemens.com/WW/view/en/10805878>)

Navigate to the desired product group there.

- **Documentation in the STEP 7 V5 installation**

Manuals that are included in the online documentation of the STEP 7 installation on your PG/PC can be found in the start menu ("Start" > "All Programs" > "Siemens Automation" > "Documentation").

- **Documentation on the data storage medium**

You will find some of the documentation for the "SIMATIC NET PC Software" products directly on the data storage medium or, after installation, in the folder "%ProgramFiles%\Siemens\SIMATIC.NET\doc".

### On configuring, commissioning and using the CP

/1/

SIMATIC NET  
S7 CPs for Industrial Ethernet  
Configuring and Commissioning  
Manual Part A - General Applications  
Configuration Manual  
Siemens AG  
Link: (<http://support.automation.siemens.com/WW/view/en/30374198>)

**/2/**

SIMATIC NET  
Version history / current downloads for the SIMATIC NET S7 CPs  
History document  
Siemens AG  
(SIMATIC NET Manual Collection)  
On the Internet under following entry ID:  
Link: (<https://support.industry.siemens.com/cs/ww/en/ps/15342/dl>)

**For configuration with STEP 7 / NCM S7**

**/3/**

SIMATIC NET  
NCM S7 for Industrial Ethernet  
Primer  
Siemens AG  
(part of the online documentation in STEP 7)

**/4/**

SIMATIC NET  
Commissioning PC Stations - Manual and Quick Start  
Configuration Manual  
Siemens AG  
Link: (<http://support.automation.siemens.com/WW/view/de/13542666>)

**/5/**

SIMATIC  
Configuring Hardware and Connections with STEP 7  
Siemens AG  
Part of the documentation package "STEP 7 Basic Knowledge"  
(Part of the online documentation in STEP 7)

## On programming

**/6/**

SIMATIC NET  
Program blocks for SIMATIC NET S7 CPs  
Version history, reference document  
Siemens AG  
Entry ID: Link: (<https://support.industry.siemens.com/cs/ww/en/ps/15342/dl>)

**/7/**

SIMATIC  
Programming with STEP 7  
Siemens AG  
(Part of the STEP 7 documentation package STEP 7 Basic Knowledge)  
(Part of the online documentation in STEP 7)  
Link: (<http://support.automation.siemens.com/WW/view/de/18652056>)

**/8/**

SIMATIC  
System and Standard Functions for S7-300/400  
Programming manual  
Siemens AG  
Link: (<http://support.automation.siemens.com/WW/view/de/1214574>)

**/9/**

SIMATIC NET  
Industrial Communication with PG/PC Volume 1 - Basics  
System Manual  
Siemens AG  
Link: (<https://support.industry.siemens.com/cs/ww/en/view/77376110>)

SIMATIC NET  
Industrial Communication with PG/PC Volume 2- Interfaces  
Programming Manual  
Siemens AG  
Link: (<https://support.industry.siemens.com/cs/ww/en/view/77378184>)

**/10/**

SIMATIC NET  
Program blocks for SIMATIC NET S7 CPs  
Programming Manual  
Siemens AG  
Link: (<https://support.industry.siemens.com/cs/ww/en/view/62543517>)

**/11/**

Automatisieren mit STEP 7 in AWL und SCL (ISBN: 978-3-89578-280-0) /  
Automating with STEP 7 in STL and SCL (ISBN: 978-3-89578-295-4)  
User manual, programming manual  
Berger, Hans  
Publicis KommunikationsAgentur GmbH, GWA, 2006

## On installing and commissioning the CP

**/12/**

SIMATIC S7  
S7-300 Automation System  
Siemens AG

- CPU 31xC and 31x Installation: Operating instructions  
Link: (<https://support.industry.siemens.com/cs/ww/en/view/13008499>)
- Module Data: Reference manual  
Link: (<https://support.industry.siemens.com/cs/ww/en/view/8859629>)

## For application and configuration of PROFINET IO

**/13/**

SIMATIC  
PROFINET System Description  
System manual  
Siemens AG  
(SIMATIC NET Manual Collection)  
On the Internet under following entry ID:  
Link: (<http://support.automation.siemens.com/WW/view/en/19292127>)

**/14/**

SIMATIC  
From PROFIBUS DP to PROFINET IO  
Programming manual  
Siemens AG  
(SIMATIC NET Manual Collection)

## On setting up and operating an Industrial Ethernet network

**/15/**

SIMATIC NET  
Industrial Ethernet  
System manual  
Siemens AG

- Volume 1: Industrial Ethernet  
Link: (<https://support.industry.siemens.com/cs/ww/de/view/27069465>)
- Volume 2: Passive network components  
Link: (<https://support.industry.siemens.com/cs/ww/en/view/84922825>)

## SIMATIC and STEP 7 basics

**/17/**

SIMATIC  
Communication with SIMATIC  
System Manual  
Siemens AG  
Link: (<http://support.automation.siemens.com/WW/view/en/25074283>)

**/18/**

- Documentation package "STEP 7 Basic Knowledge"
- Working with STEP 7 Getting Started (ID: 18652511)
  - Programming with STEP 7 (ID: 18652056)
  - Configuring Hardware and Connections with STEP 7 (ID: 18652631)
  - From S5 to S7, Converter Manual (ID: 1118413)

Siemens AG  
Order number 6ES7 810-4CA08-8AW0  
(part of the online documentation in STEP 7)

## Other topics

### **/19/**

Ethernet, IEEE 802.3 (ISO 8802-3)  
(<http://www.ieee.org>)

### **/20/**

RFC 1006 (ISO Transport Service on top of the TCP Version: 3)  
Request For Comment  
(<http://www.ietf.org>)

### **/21/**

RFC 793 (TCP)  
(<http://www.ietf.org>)

### **/22/**

RFC 791 (IP)  
(<http://www.ietf.org>)

# Index

## A

Abbreviation "CX", 11  
Addressing, 39

## C

Connection and system diagnostics, 5  
CX (abbreviation), 11

## D

Diagnostics, 40  
Disposal, 7  
Documentation, 5  
Download, 39  
Downloads, 5

## F

FETCH/WRITE  
    Access coordination, 5

## G

Glossary, 6  
GSDML file, 26

## I

IP configuration, 5

## M

MAC address, 4, 61

## O

Open communication services, 5

## P

Ping, 55  
PROFInergy, 11  
Programmed connections and IP configuration, 5

## R

Recycling, 7

## S

SIMATIC NET glossary, 6  
STEP 7, 4  
STEP 7 version, 11, 25

## V

Version history, 5