

Application example • 06/2016

# SIMATIC PCS 7 Minimal Configuration

SIMATIC PCS 7 V8.2



## Warranty and liability

### Note

The Application Examples are not binding and do not claim to be complete regarding the circuits shown, equipping and any eventuality. The Application Examples do not represent customer-specific solutions. They are only intended to provide support for typical applications. You are responsible for ensuring that the described products are used correctly. These Application Examples do not relieve you of the responsibility to use safe practices in application, installation, operation and maintenance. When using these Application Examples, you recognize that we cannot be made liable for any damage/claims beyond the liability clause described. We reserve the right to make changes to these Application Examples at any time without prior notice.

If there are any deviations between the recommendations provided in these Application Examples and other Siemens publications – e.g. Catalogs – the contents of the other documents have priority.

We do not accept any liability for the information contained in this document. Any claims against us – based on whatever legal reason – resulting from the use of the examples, information, programs, engineering and performance data etc., described in this Application Example shall be excluded. Such an exclusion shall not apply in the case of mandatory liability, e.g. under the German Product Liability Act (“Produkthaftungsgesetz”), in case of intent, gross negligence, or injury of life, body or health, guarantee for the quality of a product, fraudulent concealment of a deficiency or breach of a condition which goes to the root of the contract (“wesentliche Vertragspflichten”). The damages for a breach of a substantial contractual obligation are, however, limited to the foreseeable damage, typical for the type of contract, except in the event of intent or gross negligence or injury to life, body or health. The above provisions do not imply a change of the burden of proof to your detriment.

Any form of duplication or distribution of these Application Examples or excerpts hereof is prohibited without the expressed consent of the Siemens AG.

### Security information

Siemens provides products and solutions with industrial security functions that support the secure operation of plants, systems, machines and networks. In order to protect plants, systems, machines and networks against cyber threats, it is necessary to implement – and continuously maintain – a holistic, state-of-the-art industrial security concept. Siemens’ products and solutions only form one element of such a concept.

Customer is responsible to prevent unauthorized access to its plants, systems, machines and networks. Systems, machines and components should only be connected to the enterprise network or the internet if and to the extent necessary and with appropriate security measures (e.g. use of firewalls and network segmentation) in place.

Additionally, Siemens’ guidance on appropriate security measures should be taken into account. For more information about industrial security, please visit <http://www.siemens.com/industrialsecurity>.

Siemens’ products and solutions undergo continuous development to make them more secure. Siemens strongly recommends to apply product updates as soon as available and to always use the latest product versions. Use of product versions that are no longer supported, and failure to apply latest updates may increase customer’s exposure to cyber threats.

To stay informed about product updates, subscribe to the Siemens Industrial Security RSS Feed under <http://www.siemens.com/industrialsecurity>.

# Preface

## The aim of this document

Typical PCS 7 systems have at least an ES (Engineering Station) on the PC side, one or more possibly redundant servers and several OS clients (Operator Stations). In addition to the maximum availability of process control and data acquisition, there is also the possibility of integrating program adjustments or expansions in the foreground, quickly and without affecting the current process.

In contrast, small systems or stand-alone units often require very little maintenance after commissioning. To achieve high efficiency, there exists the requirement to get along with as few PC stations as possible. It therefore makes sense to utilize the rarely used ES as an OS in process mode.

This document is intended to serve as a selection guide in the search for the ideal PC constellations in small systems. It compares various minimal configurations (up to a max of three PCs) in terms of their functionality. Since the corresponding PCS 7 configuration is not the main focus of the system documentation, here you can also find the necessary activities required for the installation in form of detailed step instructions.

## Key content

The main focus lies in the following topics:

- Configuration comparison regarding functionality
- Activities for configuration, activation and maintenance of various configurations

# Table of contents

<b>Warranty and liability</b> .....	<b>2</b>
<b>Preface</b> .....	<b>3</b>
<b>1 Overview of the minimal configuration</b> .....	<b>6</b>
1.1 ES/OS single-user system .....	6
1.2 ES/OS client and OS server .....	7
1.3 ES, Master OS and Standby OS .....	8
1.4 ES/Master OS and Standby OS .....	9
<b>2 General/optional system settings</b> .....	<b>11</b>
2.1 Bus connection of the PC stations .....	11
2.2 Autostart of WinCC.....	11
<b>3 ES/OS single-user system</b> .....	<b>12</b>
3.1 Configuration description.....	12
3.2 Required hardware and software licensing .....	13
3.3 Step-by-Step configuration .....	14
3.3.1 ES configuration .....	14
3.3.2 OS configuration.....	20
3.3.3 Activating the runtime.....	23
3.3.4 Particularities when loading the OS project changes.....	23
<b>4 ES/OS client and OS server</b> .....	<b>24</b>
4.1 Configuration description.....	24
4.2 Required hardware and software licensing .....	25
4.3 Step-by-Step configuration .....	26
4.3.1 Preparatory activities.....	26
4.3.2 ES configuration .....	26
4.3.3 OS configuration.....	42
4.3.4 Activating the runtime.....	48
4.3.5 Particularities when loading the OS project changes.....	48
<b>5 ES, Master OS and Standby OS</b> .....	<b>49</b>
5.1 Configuration description.....	49
5.2 Required hardware and software licensing .....	51
5.3 Step-by-Step configuration .....	52
5.3.1 ES configuration .....	52
5.3.2 OS configuration.....	67
5.3.3 Activating the runtime.....	74
<b>6 ES/Master OS and Standby OS</b> .....	<b>75</b>
6.1 Configuration description.....	75
6.2 Required hardware and software licensing .....	78
6.3 Step-by-Step configuration .....	79
6.3.1 ES configuration .....	79
6.3.2 OS configuration.....	91
6.3.3 Activating the runtime.....	99
6.3.4 Particularities when loading the OS project changes.....	99
<b>7 Expansion with the PCS 7 OS Web Option</b> .....	<b>100</b>
7.1 Web configurations.....	101
7.2 Web-specific hardware and software requirements .....	103
7.3 Maximum amount of Web client connections.....	104
7.4 Configuring the OS Web Server.....	105
7.4.1 Publishing project data .....	106

## Table of contents

---

7.4.2	Setting up user rights, website start screen and language .....	109
7.4.3	Configuring with the Web Configurator .....	110
7.4.4	Downloading and compiling the Web Server .....	113
7.5	Settings for the Web client .....	114
7.6	Installing the Web client plug-ins.....	118
<b>8</b>	<b>History.....</b>	<b>120</b>

# 1 Overview of the minimal configuration

There are various constellations possible when utilizing the engineering station in process mode as an operator station or multiple operator stations with as few PCs as possible. The following versions were selected according to their feasibility and usefulness in the context of PCS 7.

The configurations shown here also include descriptions of solutions with configurations that do not differ significantly from each other.

In general, particular functionality criteria must be considered when using the engineering PC as an OS, because the OS project must be closed when performing certain activities. This will also be discussed in more detail below.

## 1.1 ES/OS single-user system

The smallest of all configurations only requires one PC station.



### Process mode / functionality

Since version 6.1 of PCS 7, the OS project can also be compiled when the runtime is activated (change compilation). Thus, the operator and archiving functions are given permanently.

**Note** The description and configuration instructions for this configuration can be found in chapter 3 "ES/OS single-user system".

### Alternatives / variations

The complete SIMATIC PCS 7 BOX package is also a good alternative. It combines the AS, OS and ES in a compact PC system. A PROFIBUS interface is also integrated to connect the distributed process I/O.

**Note** The ES/OS single-user system can also be extended with the functionality of the PCS 7 OS Web Server. You can find the corresponding instructions in chapter 7 "Expansion with the PCS 7 OS Web Option".

## 1.2 ES/OS client and OS server

With an additional PC station as an OS server, the ES can be used as an OS client. This receives access to the data of the OS server in process mode and visualizes them.

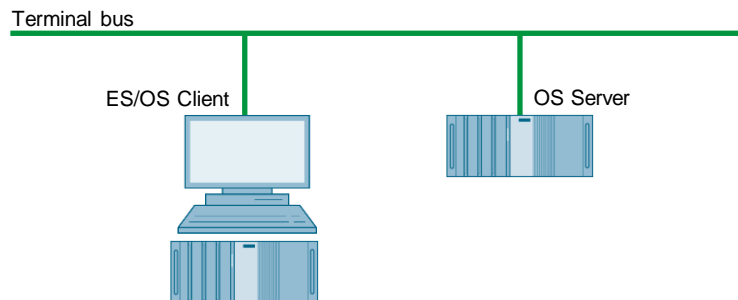

### Process mode / functionality

In PCS 7, the OS server may be used for operator functions when not more than four OS clients are connected. In this example, if the server malfunctions, the complete OS functionality fails. Besides this, the OS client must be terminated for OS project changes occurring at a later stage. But the OS server keeps on working permanently when compiling/loading changes.

#### Note

The description and configuration instructions for this configuration can be found in chapter 4 "ES/OS client and OS server".

### Alternatives / variations

An advantage of this configuration is the possibility to connect additional clients to the OS server in a relatively simple and inexpensive manner.

## 1.3 ES, Master OS and Standby OS

Three PC stations are required for the PCS 7–compliant implementation of OS redundancy. Then, the ES fulfills exclusively engineering tasks and during operation it only serves for testing OS functions.

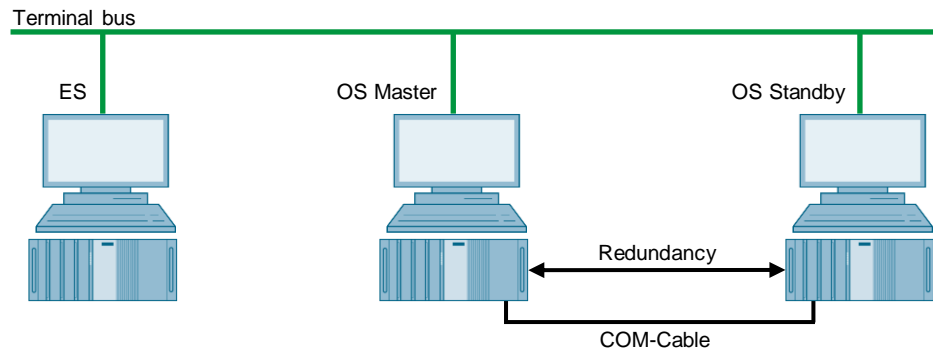

### Process mode / functionality

Since the ES is not involved in the process mode, the operator functions of the two OS single stations are permanently available. The OS remains active, even during complete loading of project changes. The redundancy ensures mutual synchronization, both when online and after the failure of one of the two partners.

The COM connection (RS 232 connecting cable) serves for the optimization of internal server to server communication.

As from PCS 7 V7.0, a separate Ethernet connection (free on-board or additional network adapter) can be used for redundancy connection as an alternative to the COM connection.

### Note

The description and configuration instructions for this configuration can be found in chapter 5 "ES, Master OS and Standby OS".

### Alternatives / variations

For the low-maintenance systems primarily mentioned in this document, one can often omit having a permanently present ES when a temporary ES is rented for configuring, commissioning and project changes.

In this example, the conceivable expansion with additional OS clients is not readily possible because the two OSs are not installed with a server operating system.



## 1.4 ES/Master OS and Standby OS

In this configuration with two redundant OS single stations, one of the two stations also serves as a simultaneous ES, which saves the need for a separate third station.

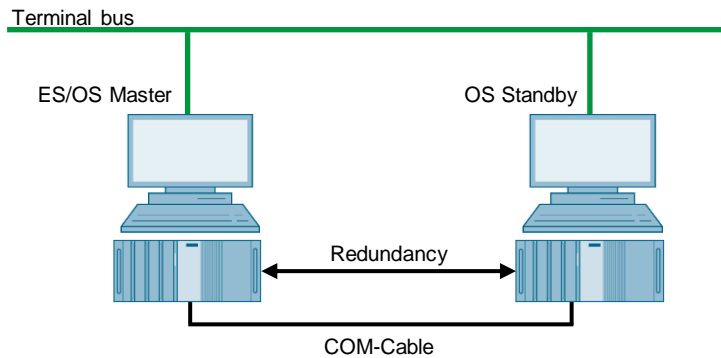

### Process mode / functionality

In this example both PC stations work in process mode as redundant OS single stations that balance off each other both in operation and after a failure of one of the two partners. This is also relevant for later OS project changes, which require the Master OS to be exited. In this case, the Standby OS takes over the master role. It keeps on working permanently while compiling/loading changes and updates the redundancy partner after it returns.

The COM connection (RS 232 connecting cable) is used to optimize the internal communication between the two OS single stations.

As from PCS 7 V7.0, a separate Ethernet connection (free on-board or additional network adapter) can be used for redundancy connection as an alternative to the COM connection. For a complete loading, the runtime and OS must be turned off and closed on both stations. During this time, no OS functionalities are available.

### Note

This configuration does not provide the entire PCS 7 functionality, since the design of the redundancy is done by means of WinCC tools.

The appropriate restrictions during process mode and the differences in the system behavior can be found together with the description and configuration instructions in chapter 6 "ES/Master OS and Standby OS".

#### **Alternatives / variations**

For a PCS 7–compliant implementation of OS redundancy, it is recommended to use three PC stations. With the change in the licensing scheme concept, PCS 7 V8.0 will require the same amount of license packages for this. The implementation of redundancy with two PC stations is associated with some limitations (see chapter 6.1 "Configuration description") and only saves you one computer (hardware and Windows license), when compared to the PCS 7–compliant implementation with a separate ES and two redundant OS single stations (see chapter 1.3 "ES, Master OS and Standby OS").

#### **Note**

The ES/OS single-user system can also be extended with the functionality of the PCS 7 OS Web Server. You can find the corresponding instructions in chapter 7 "Expansion with the PCS 7 OS Web Option".

## 2 General/optional system settings

The system settings relevant for configuration are proposed in the following section.

### 2.1 Bus connection of the PC stations

#### System bus

In the ES as well as in each server, a network card is used in "Configured mode" for the system bus. On this network card, only the ISO protocol is enabled for Windows. If a CP1623 exists, it is used for access to the system bus. The parameter assignment is done in SIMATIC NetPro and in the HW Config.

#### Terminal bus

Except for the configuration with only one ES/OS single-user system, all other PC stations are otherwise also linked to the terminal bus. The required second network card by the ES and the server is here set to "PG mode". This card is not configured in SIMATIC NetPro and in the HW Config PCS 7 finds this network access via the computer name or the specified path for the target machine that needs to be entered in the object properties of the PC station. For this network card, only the TCP/IP protocol (no ISO) is activated in Windows.

Client PC stations are generally equipped with only one network card, with which they are connected to the terminal bus. For this network card, only the TCP/IP protocol (no ISO) is activated in Windows.

### 2.2 Autostart of WinCC

The step instructions in this document specify that the OS project is opened in WinCC Explorer of the OS servers and clients for the purpose of activating the runtime.

This should be mostly avoided in the system, since there are generally no configuration licenses (RC licenses) on the OSs. If the WinCC Explorer is open for longer than two hours, WinCC switches to Demo mode and must be completely closed (incl. runtime) and reopened for further configuration steps.

To activate the runtime automatically when the computer starts without having to open WinCC explorer, one can configure an automatic start for the project.

In conjunction with SIMATIC NET 2005 Edition (as from WinCC V6.0 SP3), the WinCC tool "AutoStartRT" should be configured in "Set configuration console PC station" in order to configure the WinCC automatic start:

<https://support.industry.siemens.com/cs/ww/en/view/23061262>

## 3 ES/OS single-user system

### 3.1 Configuration description

The single-user system is the smallest possible configuration. Both the ES and the OS functionalities are provided by the same PC.

#### Hardware assembly

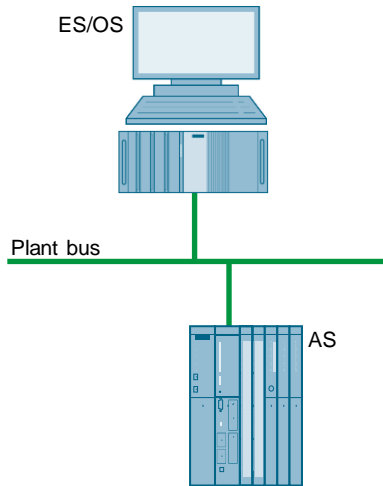

#### PCS 7 configuration

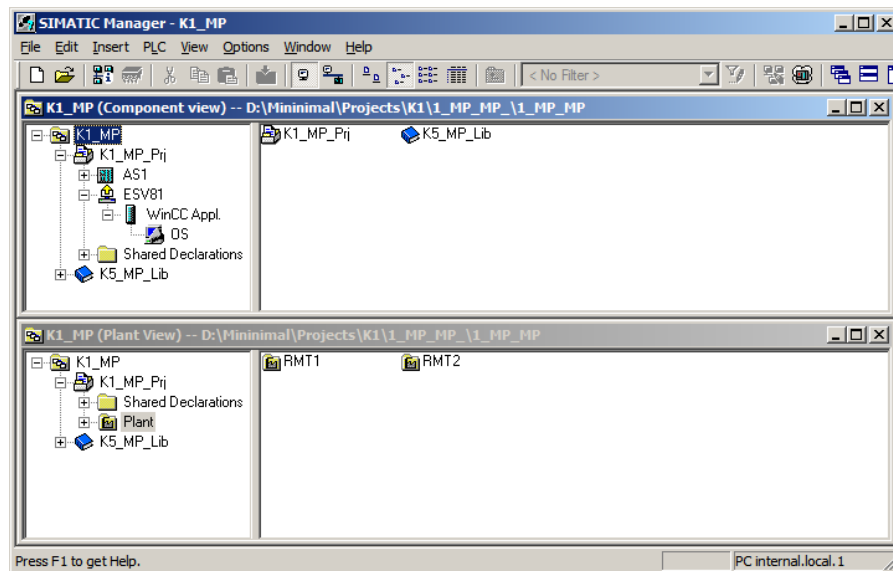

## 3.2 Required hardware and software licensing

### Hardware

The following hardware is recommended for this configuration and can be ordered via the Siemens mall. Your selected operating system and SIMATIC PCS 7 system software is preinstalled on the PC station in its relevant scope.

Station	Product label	Operating system	System bus transition
1 x ES/OS	SIMATIC PCS 7 ES/OS IPC847D BCE	Windows 7	RJ45 network card
	SIMATIC PCS 7 ES/OS IPC847D IE	Windows 7	CP1623

### Software licensing

The following section lists the software/license package required for this configuration selection.

In the selected configuration as a single-user system, the number of POs is limited to a maximum of 2000 units.

Component	Software/licence package
ES/OS	<ul style="list-style-type: none"> <li>• SIMATIC PCS 7 ES Single Station (incl. 250 AS/OS runtime PO)</li> <li>• SIMATIC PCS 7 AS runtime licence</li> <li>• SIMATIC PCS 7 OS runtime licence (max. 2000 PO)</li> </ul>

### 3.3 Step-by-Step configuration

**Note** The following instructions have been created based on Windows 7 and PCS 7 V8.2.  
A CP1623 is used as an example for the system bus transition.

#### 3.3.1 ES configuration

##### Creating the multiproject

As a basis for the following instructions, the station must be physically connected according to the chart in chapter 3.1 (page 12). A multiproject must be also created on the ES, where the hardware and software of the AS are already configured.

##### Creating a PC station

The PC station is created in the PCS 7 project the PC station that represents both the ES and the OS.

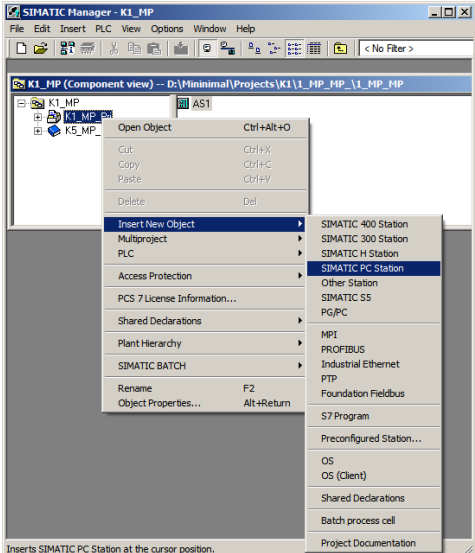
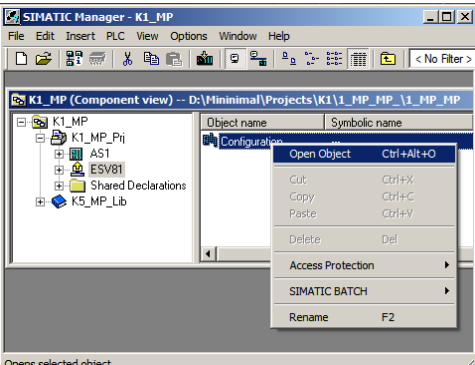
Step	Activity	Screenshot
1.	<p>Open the shortcut menu of the project in the component view and add a new PC station via "Insert New Object &gt; SIMATIC PC station".</p> <p>Change the name of the PC station to match the name of the local computer on the network.</p>	 <p>The screenshot shows the SIMATIC Manager interface with the 'Component view' of a project. A context menu is open over the project tree, and the 'Insert New Object' option is selected. A sub-menu is displayed, showing 'SIMATIC PC Station' as the chosen option. Other options include SIMATIC 400 Station, SIMATIC 300 Station, SIMATIC H Station, SIMATIC 55, FG/PC, MPI, PROFIBUS, Industrial Ethernet, PTP, Foundation Fieldbus, S7 Program, Preconfigured Station..., OS, OS (Client), Shared Declarations, Batch process cell, and Project Documentation.</p>
2.	<p>Open the HW Config of the PC station via the shortcut menu.</p>	 <p>The screenshot shows the SIMATIC Manager interface with the 'Component view' of a project. A context menu is open over a selected object, and the 'Configuration' option is selected. A sub-menu is displayed, showing 'Open Object' as the chosen option. Other options include Cut, Copy, Paste, Delete, Access Protection, SIMATIC BATCH, and Rename.</p>

### 3 ES/OS single-user system

#### 3.3 Step-by-Step configuration

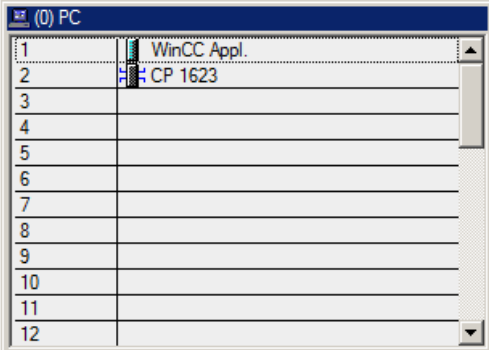
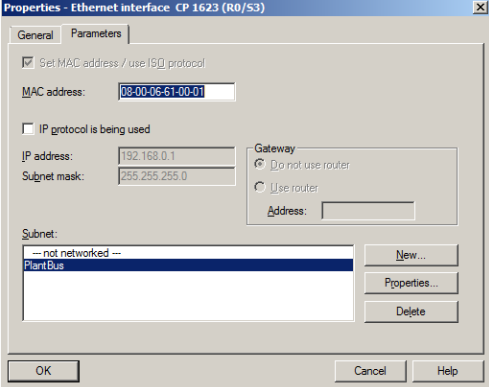
Step	Activity	Screenshot
3.	<p>From the object catalog (View &gt; Catalog) insert a "WinCC application" and a network card of the type "CP1623".</p>	 <p>The screenshot shows a window titled '(0) PC' with a list of objects. Object 1 is 'WinCC Appl.' and object 2 is 'CP 1623'. Objects 3 through 12 are empty.</p>
4.	<p>Select the system bus from "Subnet" or set this by pressing the "New..." button. Assign the corresponding MAC address to the CP1623. Deactivate the check box "IP protocol is being used". Click the "OK" button to confirm the settings.</p>	 <p>The screenshot shows the 'Properties - Ethernet interface CP 1623 (R0/S3)' dialog box. The 'Parameters' tab is active. The 'Get MAC address / use ISO protocol' checkbox is checked, and the MAC address is '08-00-06-61-00-01'. The 'IP protocol is being used' checkbox is unchecked. The IP address is '192.168.0.1' and the subnet mask is '255.255.255.0'. The 'Gateway' section has 'Do not use router' selected. The 'Subnet' dropdown menu is open, showing 'PlantBus' selected. Buttons for 'New...', 'Properties...', and 'Delete' are visible.</p>
5.	<p>Save and compile the configuration via the menu command: "Station &gt; Save and compile..." Close the HW Config</p>	

### Configuring the PC station

The function "Configure PC station" transfers project configurations to one or more target stations.

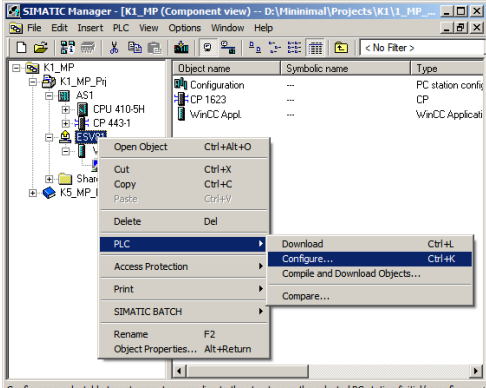
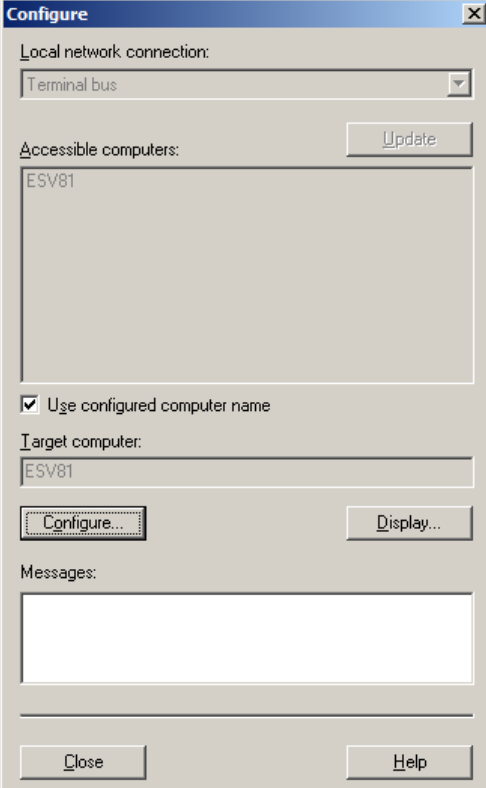
Step	Activity	Screenshot
1.	<p>Configure the Station Configuration Editor of the ES. To do this, select the PC station of the ES and then choose "PLC &gt; Configure..." in the shortcut menu.</p>	 <p>The screenshot shows the SIMATIC Manager interface. A context menu is open over a selected PLC station. The menu items include 'Open Object', 'Cut', 'Copy', 'Paste', 'Delete', 'PLC', 'Access Protection', 'Print', 'SIMATIC BATCH', 'Rename', and 'Object Properties...'. The 'PLC' menu item is expanded, showing sub-options: 'Download', 'Configure...', 'Compile and Download Objects...', and 'Compare...'. The 'Configure...' option is highlighted.</p>
2.	<p>Select the PC to be configured from "Accessible computers:".</p> <p><b>NOTE</b> If you have chosen the option "Identical PC name PC station name" via "Object properties", the target PC to be configured appears directly in the component configurator.</p> <p>Use the "Show" button to display the current configuration of the PC station. Click on the "Configure..." button.</p>	 <p>The screenshot shows the 'Configure' dialog box. It has a 'Local network connection' dropdown set to 'Terminal bus'. Below it is an 'Update' button. The 'Accessible computers' section contains a list with 'ESV81' selected. There is a checked checkbox for 'Use configured computer name'. The 'Target computer' field also contains 'ESV81'. At the bottom, there are 'Configure...', 'Display...', 'Close', and 'Help' buttons.</p>



### 3 ES/OS single-user system

#### 3.3 Step-by-Step configuration

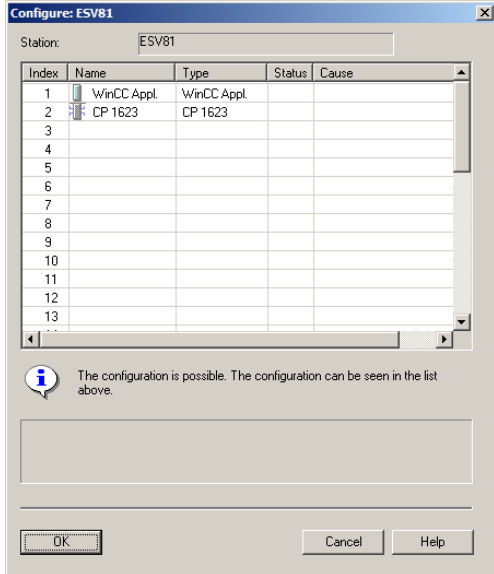
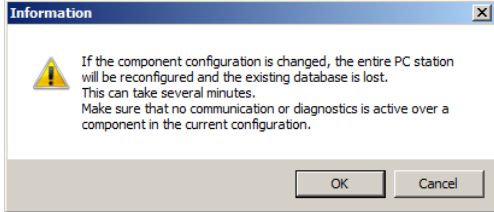
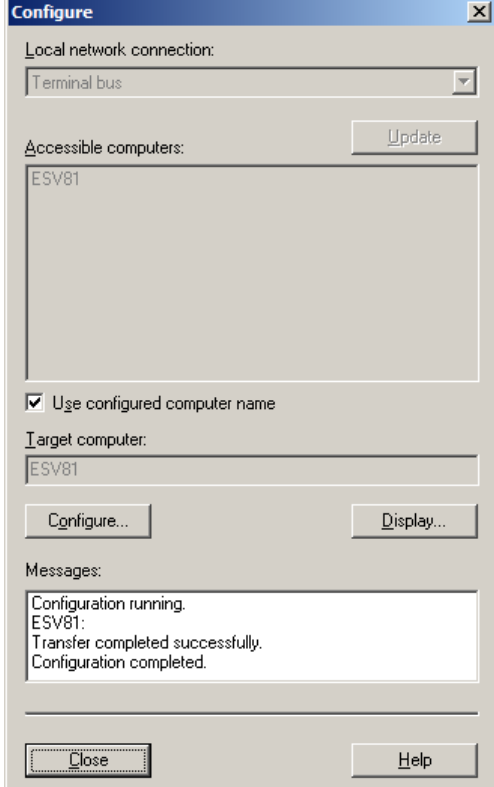
Step	Activity	Screenshot
3.	<p>In the window that appears you will see how the PC station is configured. Click the "OK" button to confirm this.</p>	
4.	<p>Confirm the information dialog by clicking the "OK" button.</p>	
5.	<p>In the bottom window you will then see the message: "Transfer completed successfully." Close the configuration dialog.</p>	

### Configuring and loading AS-OS communication

In the following section, the connection is configured with NetPro and loaded in the stations.

**Note** In case of a granular station configuration, the subnets of the individual sub-projects must be first merged.

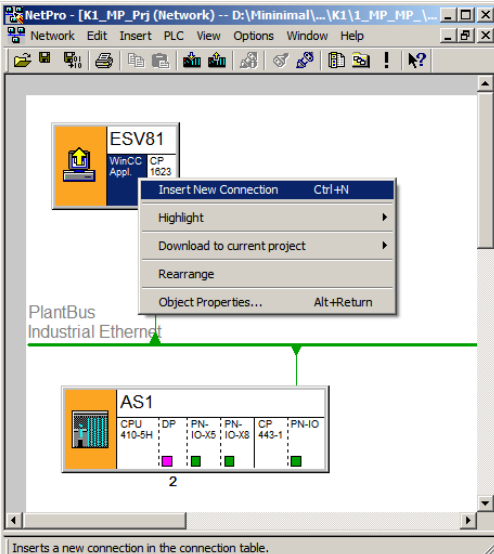
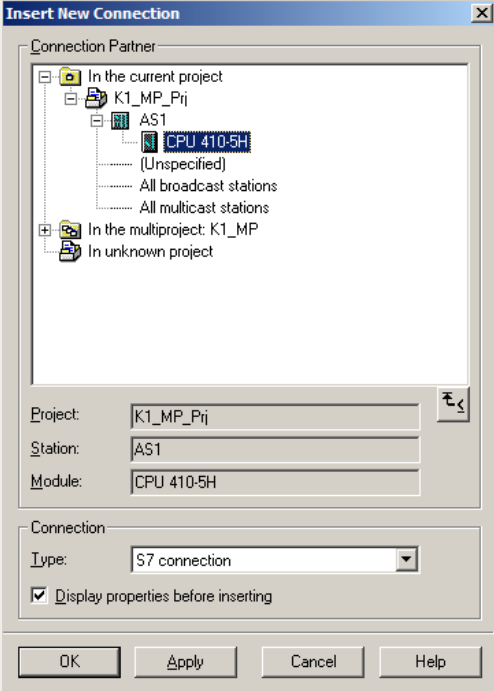
Step	Activity	Screenshot
1.	<p>Open NetPro.</p> <p>Select the WinCC application of the ES and open the shortcut menu. Select "Insert New Connection".</p>	 <p>The screenshot shows the NetPro interface with a context menu open over the 'ESV81' station. The menu options are: 'Insert New Connection' (Ctrl+N), 'Highlight', 'Download to current project', 'Rearrange', and 'Object Properties...' (Alt+Return). A green line connects the station to the 'AS1' station below it.</p>
2.	<p>Select the CPU of the AS in the "Connection Partner" window.</p> <p>Make sure that an "S7 connection" is selected under "Connection".</p> <p>Click the "OK" button to confirm the selection.</p>	 <p>The screenshot shows the 'Insert New Connection' dialog box. The 'Connection Partner' tree is expanded to show 'AS1' &gt; 'CPU 410-5H'. The 'Project' field is 'K1_MP_Pri', 'Station' is 'AS1', and 'Module' is 'CPU 410-5H'. The 'Connection Type' is set to 'S7 connection'. The 'Display properties before inserting' checkbox is checked.</p>

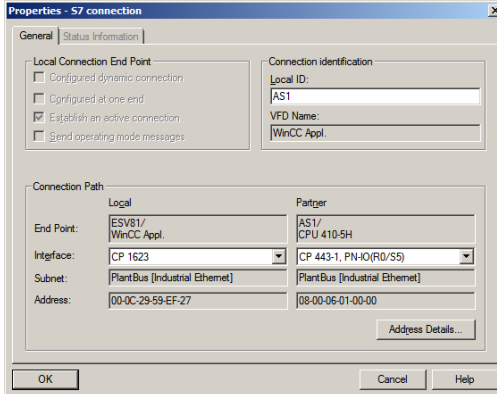
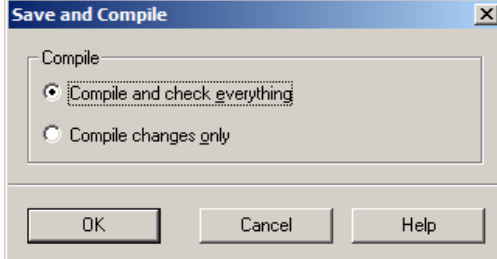
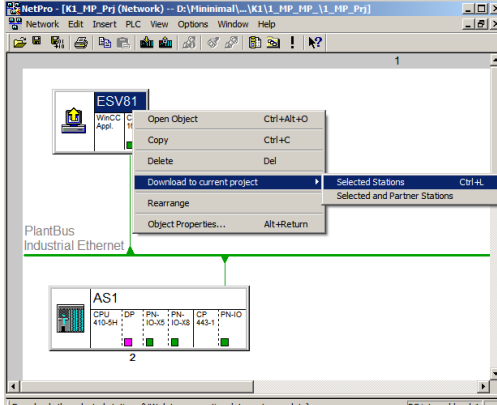
Step	Activity	Screenshot
3.	Under "Connection identification" in the "General" tab, change the "Local ID:" to a descriptive name, such as AS1. Click the "OK" button to confirm the entry.	
4.	Save and compile via : "Network > Save and Compile...". Select "Compile and check everything". Click the "OK" button to confirm the selection.	
5.	Select the ES and download the connection via the shortcut menu: "Download to current project > Selected Stations". Download the AS in the same way. Then close NetPro.	

© Siemens AG 2016 All rights reserved

### Compiling and loading the user program

Compile the S7 program and download it to the AS.

### Compiling the OS project

Compile the OS project in SIMATIC Manager.

**3.3.2 OS configuration**

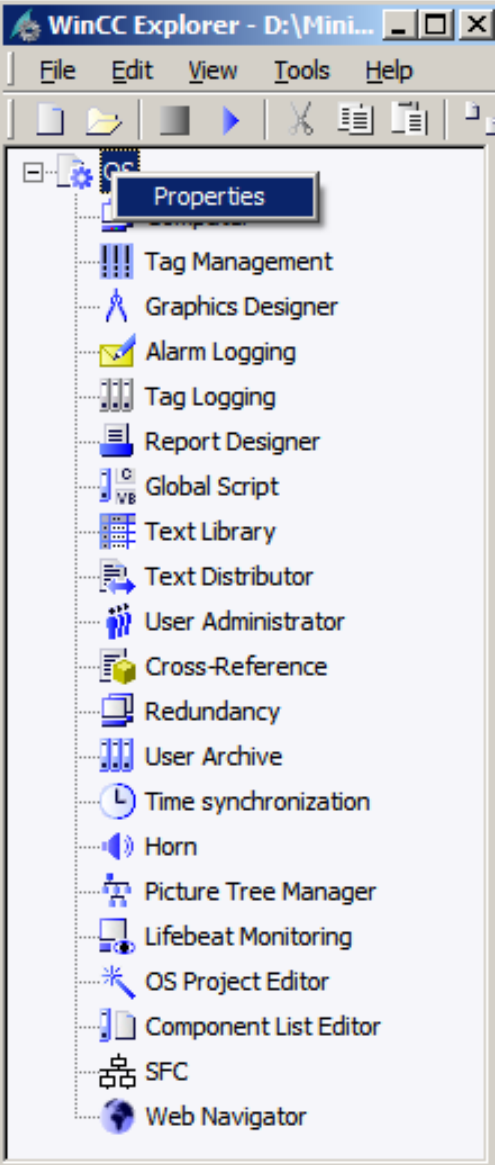
Step	Activity	Screenshot
1.	<p>Open the OS project.                      Select the OS project in the open WinCC Explorer and select "Properties" in the shortcut menu.</p>	 <p>WinCC Explorer - D:\Mini...                      File Edit View Tools Help</p> <p>Properties</p> <ul style="list-style-type: none"> <li>Tag Management</li> <li>Graphics Designer</li> <li>Alarm Logging</li> <li>Tag Logging</li> <li>Report Designer</li> <li>Global Script</li> <li>Text Library</li> <li>Text Distributor</li> <li>User Administrator</li> <li>Cross-Reference</li> <li>Redundancy</li> <li>User Archive</li> <li>Time synchronization</li> <li>Horn</li> <li>Picture Tree Manager</li> <li>Lifebeat Monitoring</li> <li>OS Project Editor</li> <li>Component List Editor</li> <li>SFC</li> <li>Web Navigator</li> </ul> <p>Press F1 for Help.</p>

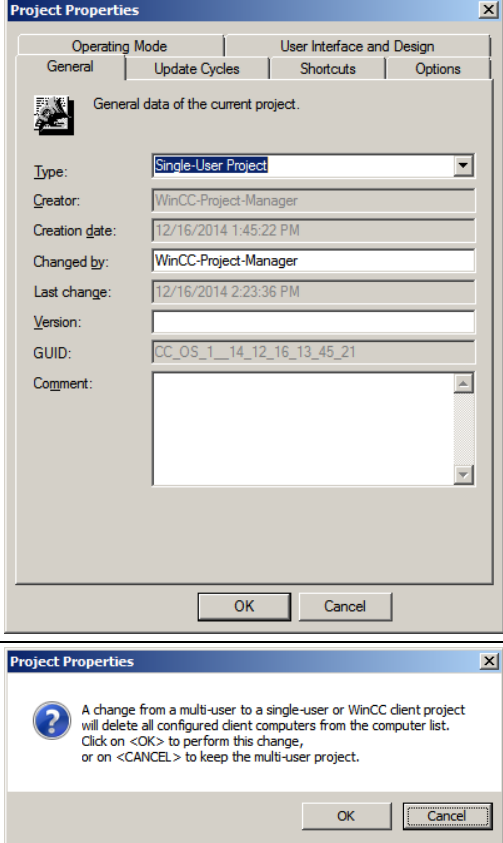
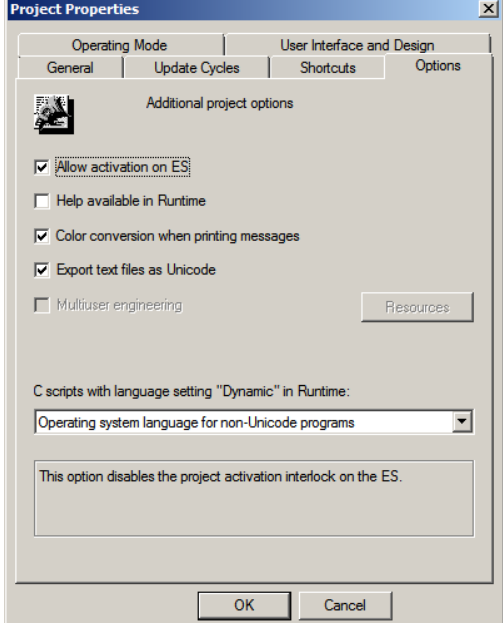
Step	Activity	Screenshot
2.	<p>Select "Single-user project" in the "General" tab under "Type:".</p> <p>Confirm your selection and the displayed message by clicking the "OK" button.</p>	
3.	<p>In the "Options" tab, select the option "Allow activation on the ES".</p>	

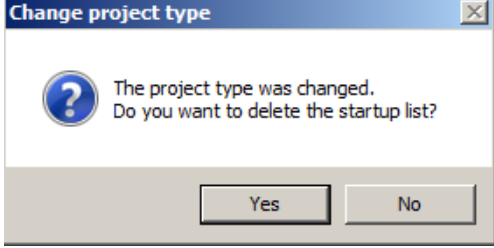
Step	Activity	Screenshot
4.	Click on the "No" button, in order to prevent the deletion of the startup list.	
5.	Close the WinCC Explorer.  <b>NOTE</b> Changes take effect only after closing and reopening the WinCC Explorer.	

### **3.3.3 Activating the runtime**

After the OS project is closed, open it again and activate the runtime.

### **3.3.4 Particularities when loading the OS project changes**

If the OS and ES are operated on a single PC, you have to perform a loading operation because all required data is already available. Here it's enough to run the "Compile OS" function.

Just like the function "Download changes", you can run the function "Compile changes" in the single-user system without exiting the process mode on the OS.

## 4 ES/OS client and OS server

### 4.1 Configuration description

In a server-client structure with only two computers, the ES serves simultaneously as an OS client. 3 PCs should be provided in this configuration.

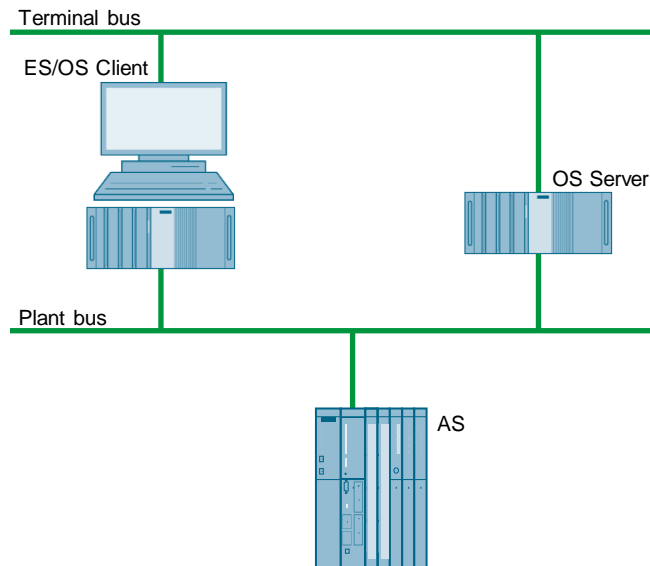

### PCS 7 configuration

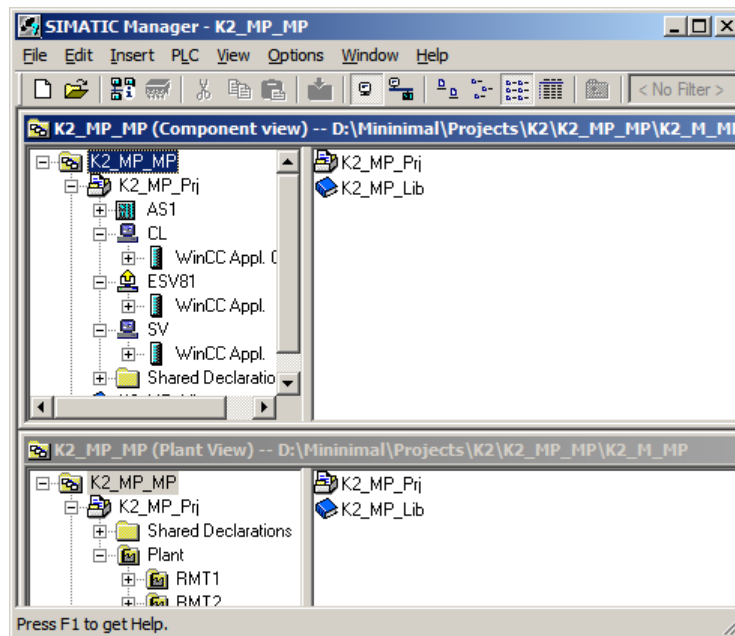



## 4.2 Required hardware and software licensing

### Hardware

The following hardware is recommended for this configuration and can be ordered via the Siemens mall. This ensures that the appropriate amount of operating systems of your choice and SIMATIC PCS 7 system software are pre-installed on the PC stations.

Station	Product label	Operating system	System bus transition
ES/OS client	SIMATIC PCS 7 ES/OS IPC847D BCE	Windows 7	RJ45 network card
	SIMATIC PCS 7 ES/OS IPC847D IE	Windows 7	CP 1623
OS server	SIMATIC PCS 7 ES/OS IPC847D BCE	Windows Server 2008 R2	RJ45 network card
	SIMATIC PCS 7 ES/OS IPC847D IE	Windows Server 2008 R2	CP 1623

### Software Licensing

The following section lists the software/license packages required for this configuration selection.

An OS server can provide up to 12,000 POs with the corresponding software package, depending on the project size. In addition to engineering software, an OS client software must be also installed on the ES.

Component	Software/license package
ES/OS client	<ul style="list-style-type: none"> <li>• SIMATIC PCS 7 AS/OS Engineering Software V8.2 (PO unlimited)</li> <li>• SIMATIC PCS 7 AS Runtime License</li> <li>• SIMATIC PCS 7 OS Software Client V8.2</li> </ul>
OS server	<ul style="list-style-type: none"> <li>• SIMATIC PCS 7 OS Software Server V8.2</li> <li>• SIMATIC PCS 7 OS Runtime License (max. 12000 PO)</li> </ul>

## 4.3 Step-by-Step configuration

### Note

The following instructions have been created based on Windows 7 and PCS 7 V8.2.

CP1623 are used as an example for the system bus transition. Time synchronization is activated.

The PC stations used in the test setup are called:

- ES/OS client: ESV81
- OS server: SV

### 4.3.1 Preparatory activities

Create a project folder on the OS server and enable it. This allows the OS data configured on the engineering station to be transferred to the OS server.

### 4.3.2 ES configuration

#### Creating the multiproject

As a basis for the following instructions, all PC stations must be physically connected according to the chart in chapter 4.1 (page 24). A multiproject must be also created on the ES, where the hardware and software of the AS are already configured.

Then you begin from the following CPU and CP settings.

**AS settings**

This example describes a way in which the OS server predetermines the master time.

**Note**

More time synchronization possibilities are described in detail in the following manuals:

- [SIMATIC Process Control System PCS 7 Operator Station \(V8.2\)](#)
- [SIMATIC Process Control System PCS 7 Time synchronization \(V8.2\)](#)

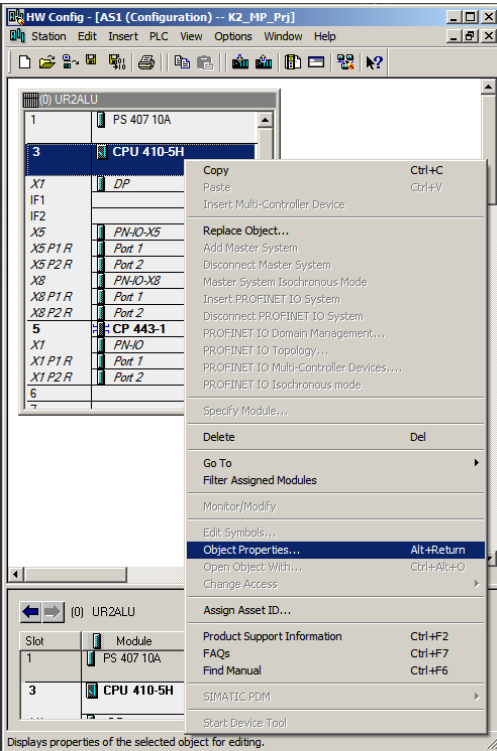
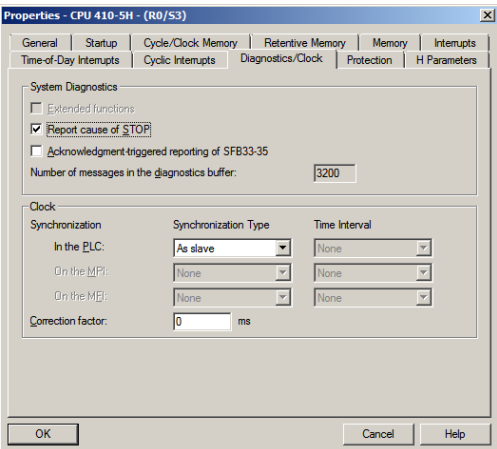
Step	Activity	Screenshot
1.	Open the HW Config for the AS. Select the CPU and choose "Object properties..." in the shortcut menu.	
2.	Switch to the "Diagnostics/Clock" tab. In the "Clock" section, set "Synchronization Type - As slave". Click the "OK" button to confirm the selection.	

4 ES/OS client and OS server

4.3 Step-by-Step configuration

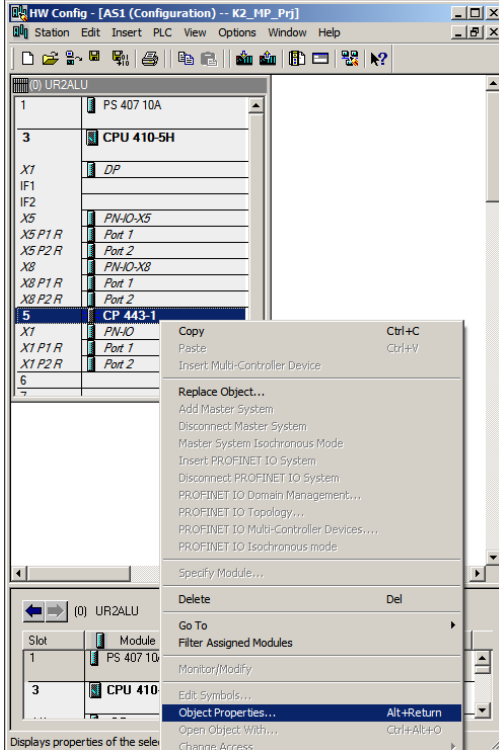
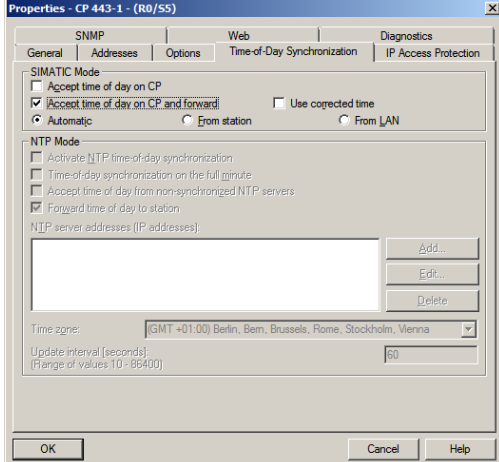
Step	Activity	Screenshot
3.	Open the shortcut menu of the CP and select "Object properties...".	 <p>The screenshot shows the HW Config interface with a context menu open over the CPU 443-1 module. The menu items include Copy, Paste, Replace Object..., Delete, Go To, Filter Assigned Modules, Monitor/Modify, Edit Symbols..., Object Properties... (highlighted), Open Object With..., and Change Access.</p>
4.	Switch to the "Time synchronization" tab. Activate the check box "Accept time of day on CP and forward". Click the "OK" button to confirm the setting.	 <p>The screenshot shows the 'Properties - CP 443-1 - (R0/S5)' dialog box. The 'Time-of-Day Synchronization' tab is active. Under 'SIMATIC Mode', the 'Accept time of day on CP and forward' checkbox is checked. Other options include 'Automatic', 'From station', and 'From LAN'. Under 'NTP Mode', 'Forward time of day to station' is checked. The 'Time zone' is set to '(GMT +01:00) Berlin, Bern, Brussels, Rome, Stockholm, Vienna' and the 'Update interval [seconds]' is set to 60.</p>
5.	Save and compile the configuration via: "Station > Save and compile...". Close the HW Config	

**Setting up the ES PC station**

In order to test the OS project on the ES, create a PC station for the ES with the WinCC application.

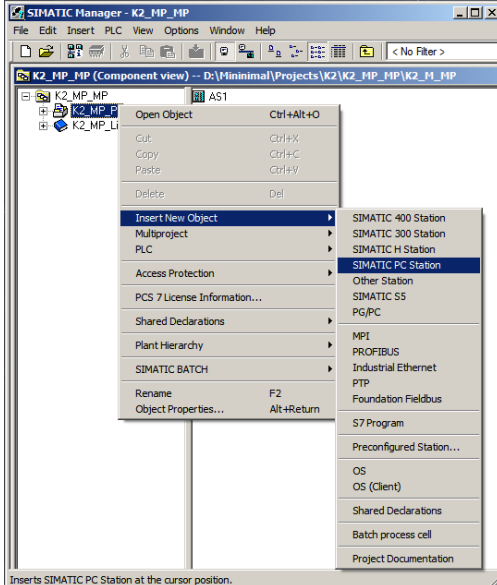
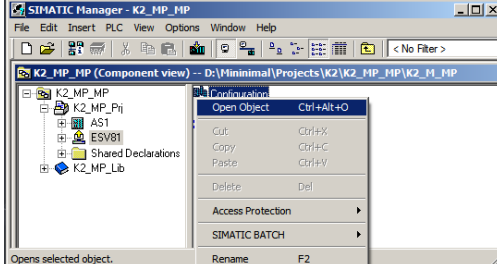
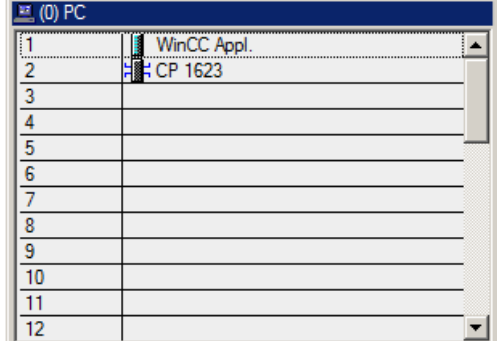
Step	Activity	Screenshot																								
1.	<p>Open the shortcut menu of the project in the component view and add a new PC station via "Insert New Object &gt; SIMATIC PC station".</p> <p>Change the name of the PC station so that it matches the name of the local computer on the network.</p>	 <p>The screenshot shows the SIMATIC Manager interface with the 'Component view' open. A context menu is displayed over the project tree, with 'Insert New Object' selected. A sub-menu is open, showing 'SIMATIC PC Station' as the selected option. Other options include SIMATIC 400 Station, SIMATIC 300 Station, SIMATIC H Station, Other Station, SIMATIC S5, PG/PC, MPI, PROFIBUS, Industrial Ethernet, PTP, Foundation Fieldbus, S7 Program, Preconfigured Station..., OS, OS (Client), Shared Declarations, Batch process cell, and Project Documentation.</p>																								
2.	<p>Open the HW Config of the PC station via the shortcut menu.</p>	 <p>The screenshot shows the SIMATIC Manager interface with the 'Component view' open. A context menu is displayed over the project tree, with 'Configuration' selected. A sub-menu is open, showing 'Open Object' as the selected option. Other options include Cut, Copy, Paste, Delete, Access Protection, SIMATIC BATCH, and Rename.</p>																								
3.	<p>From the object catalog ("View &gt; Catalog") insert a "WinCC application" and a network card of the type "CP1623".</p>	 <p>The screenshot shows the HW Config window with a table of components. The table has two columns: a numerical index (1-12) and a component name. Row 1 contains 'WinCC Appl.' and row 2 contains 'CP 1623'. The other rows are empty.</p> <table border="1" data-bbox="869 1373 1348 1713"> <tr><td>1</td><td>WinCC Appl.</td></tr> <tr><td>2</td><td>CP 1623</td></tr> <tr><td>3</td><td></td></tr> <tr><td>4</td><td></td></tr> <tr><td>5</td><td></td></tr> <tr><td>6</td><td></td></tr> <tr><td>7</td><td></td></tr> <tr><td>8</td><td></td></tr> <tr><td>9</td><td></td></tr> <tr><td>10</td><td></td></tr> <tr><td>11</td><td></td></tr> <tr><td>12</td><td></td></tr> </table>	1	WinCC Appl.	2	CP 1623	3		4		5		6		7		8		9		10		11		12	
1	WinCC Appl.																									
2	CP 1623																									
3																										
4																										
5																										
6																										
7																										
8																										
9																										
10																										
11																										
12																										

4.3 Step-by-Step configuration

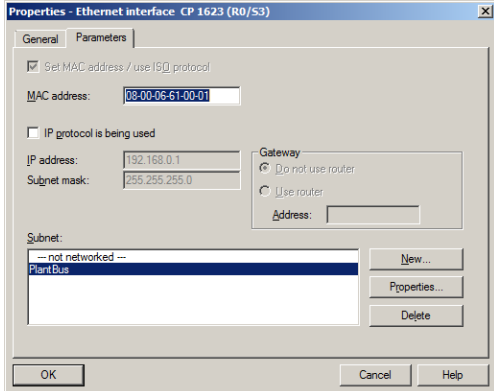
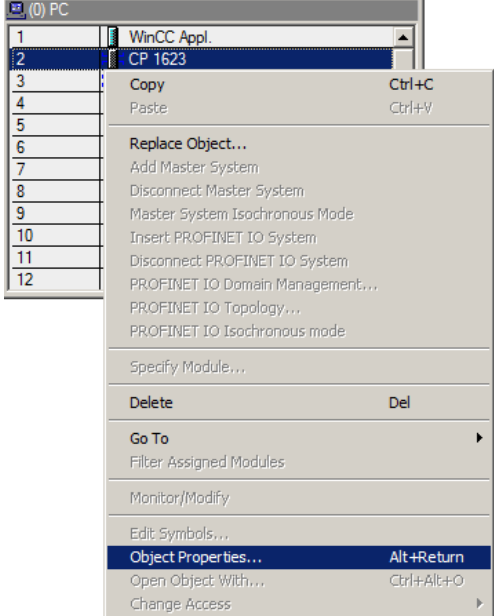
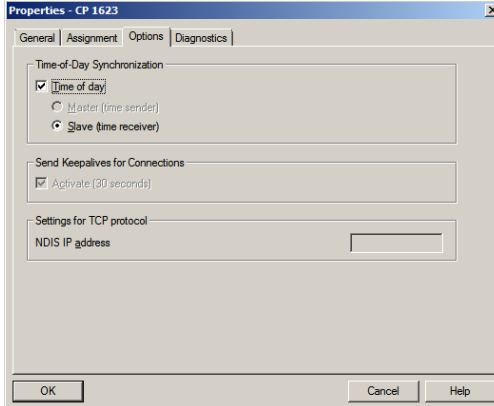
Step	Activity	Screenshot
4.	<p>Select the system bus from "Subnet" or set this by pressing the "New..." button.</p> <p>Assign the corresponding MAC address to the CP1623.</p> <p>Deactivate the check box "IP protocol is being used" .</p> <p>Click the "OK" button to confirm the settings.</p>	
5.	<p>Open the shortcut menu of the CP1623 and select "Object properties..." .</p>	
6.	<p>Go to the "Options" tab and select the check box "Time of day".</p> <p>Click the "OK" button to confirm the selection.</p>	
7.	<p>Save and compile via the menu command: "Station &gt; Save and compile...".</p> <p>Close the HW Config</p>	
8. optional	<p>In SIMATIC Manager, delete the OS application of the ES PC station, as this is not needed in our example.</p>	

Setting up the OS server PC station

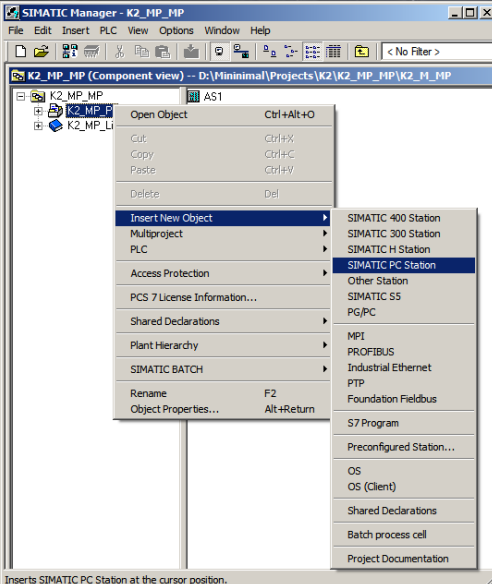
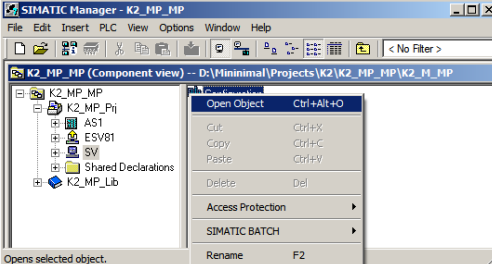
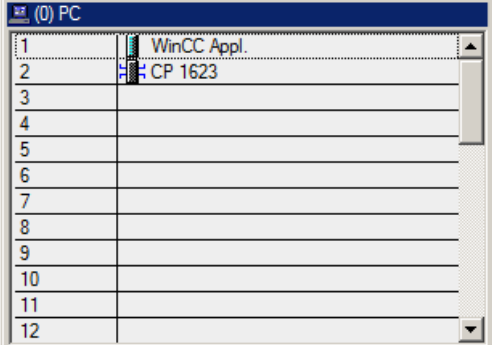
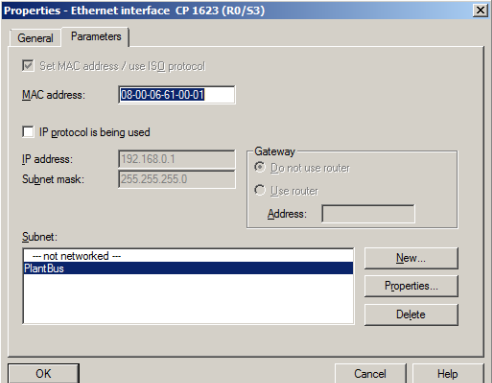
Step	Activity	Screenshot
1.	Open the shortcut menu of the project in the component view and add a new PC station via "Insert New Object > SIMATIC PC station".	 <p>The screenshot shows the SIMATIC Manager interface in Component view. A context menu is open over the project tree, with 'Insert New Object' selected. A sub-menu is displayed, showing 'SIMATIC PC Station' as the selected option. Other options include SIMATIC 400 Station, SIMATIC 300 Station, SIMATIC H Station, Other Station, SIMATIC S5, PG/PC, MPI, PROFIBUS, Industrial Ethernet, PTP, Foundation Fieldbus, S7 Program, Preconfigured Station..., OS (Client), Shared Declarations, Batch process cell, and Project Documentation.</p>
2.	Open the HW Config of the PC station via the shortcut menu.	 <p>The screenshot shows the SIMATIC Manager interface. A context menu is open over the project tree, with 'Open Object' selected. The menu options include Cut, Copy, Paste, Delete, Access Protection, SIMATIC BATCH, and Rename.</p>
3.	From the object catalog ("View > Catalog") insert a "WinCC application" and a network card of the type "CP1623".	 <p>The screenshot shows the WinCC application catalog. It displays a list of objects with columns for object name and type. 'WinCC Appl.' and 'CP 1623' are visible in the list.</p>
4.	Select the system bus from "Subnet" or set this by pressing the "New..." button. Assign the corresponding MAC address to the CP1623. Deactivate the check box "IP protocol is being used". Click the "OK" button to confirm the settings.	 <p>The screenshot shows the 'Properties - Ethernet interface CP 1623 (R0/53)' dialog box. The 'Parameters' tab is active. The 'MAC address' is set to '08-00-06-61-00-01'. The 'IP protocol is being used' checkbox is unchecked. The 'Subnet' dropdown is set to 'Plant Bus'. The 'Gateway' section has 'Do not use router' selected.</p>

4 ES/OS client and OS server

4.3 Step-by-Step configuration

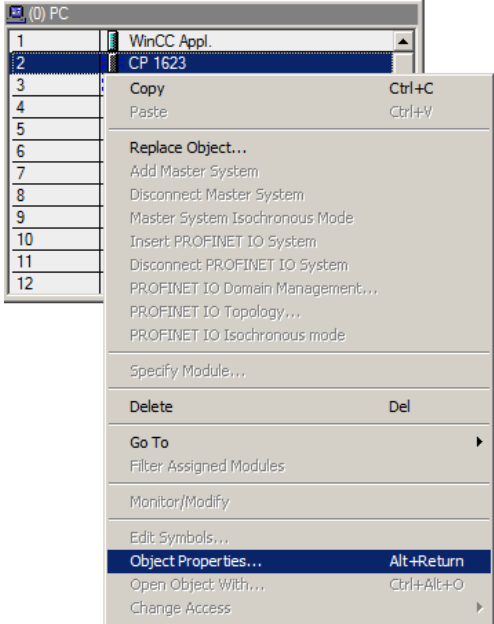
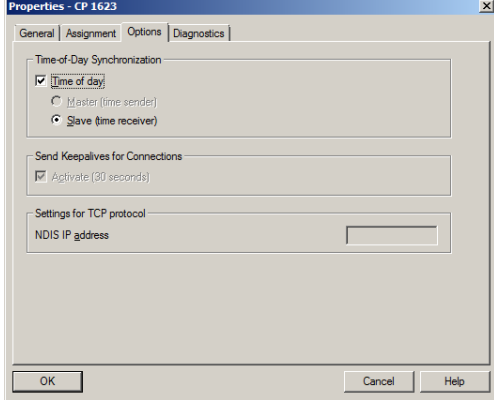
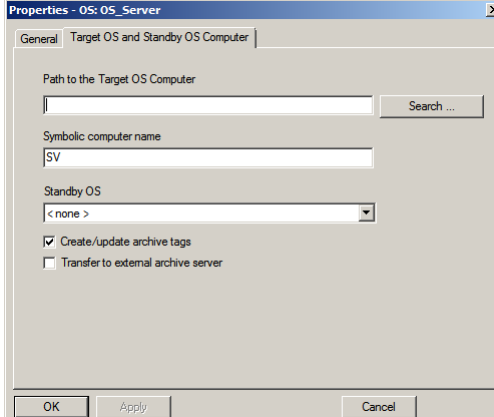
Step	Activity	Screenshot
5.	Open the shortcut menu of the CP1623 and select "Object properties...".	
6.	Go to the "Options" tab and select the check box "Time of day". Click the "OK" button to confirm the setting.	
7.	Save and compile via the menu command: "Station > Save and compile...". Close the HW Config	
8.	In SIMATIC Manager, open the properties dialog of the OS server's OS project. Switch to the "Target OS and Standby OS Computer" tab. Select < none > under "Standby OS". Then click the "Search..." button.	



## 4 ES/OS client and OS server

### 4.3 Step-by-Step configuration

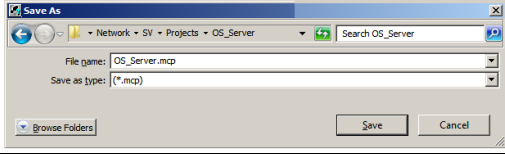
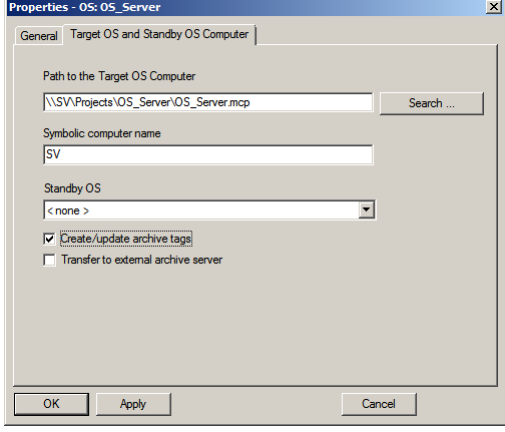
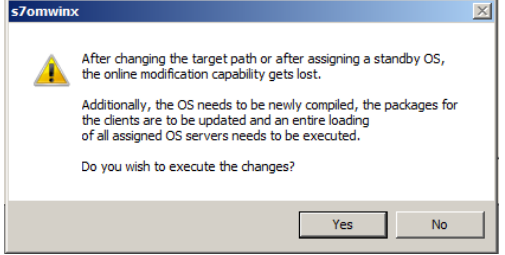
Step	Activity	Screenshot
9.	Navigate via the drop-down list to the shared project folder of the OS server (see 4.3.1 Preparatory activities). Click the "Save" button.	
10.	In the text box, select the path "Path to Target OS Computer". Click the "OK" button to confirm this.	
11.	Confirm the information dialog by clicking the "Yes" button.	

**Setting up the Client PC station**

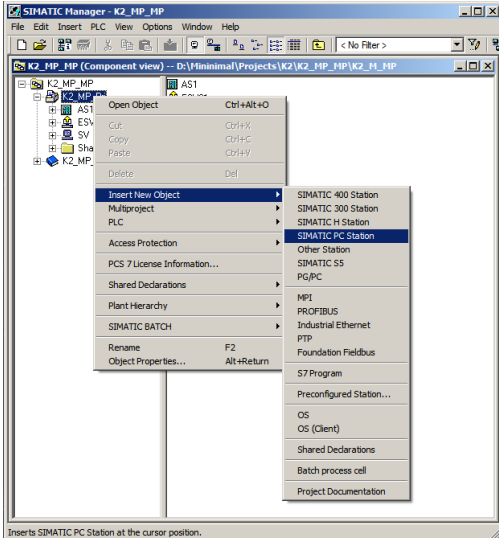
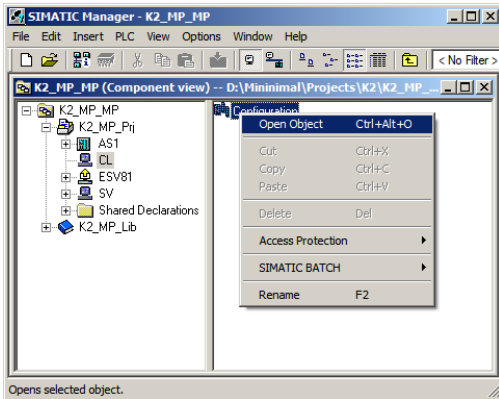
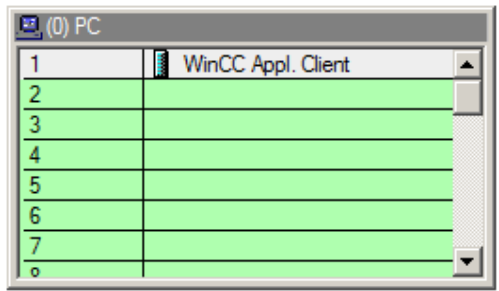
Step	Activity	Screenshot																		
1.	Open the shortcut menu of the project in the component view and add a new PC station via "Insert New Object > SIMATIC PC station".	 <p>The screenshot shows the SIMATIC Manager interface with the 'Component view' of a project. A context menu is open over the project component, with 'Insert New Object' selected. A sub-menu is displayed, showing 'SIMATIC PC Station' as the selected option. Other options include SIMATIC 400 Station, SIMATIC 300 Station, SIMATIC H Station, Other Station, SIMATIC S5, PG/PC, MPI, PROFIBUS, Industrial Ethernet, PTP, Foundation Fieldbus, S7 Program, Preconfigured Station..., OS, OS (Client), Shared Declarations, Batch process cell, and Project Documentation.</p>																		
2.	Open the HW Config of the OS client's PC station.	 <p>The screenshot shows the SIMATIC Manager interface with the 'Component view'. A context menu is open over a selected object, with 'Open Object' selected. The HW Config window is open, showing the configuration for the selected object.</p>																		
3.	From the object catalog (View > Catalog) insert a WinCC application client.	 <p>The screenshot shows a table with 7 rows and 2 columns. The first row is highlighted in green and contains the text 'WinCC Appl. Client'. The other rows are empty.</p> <table border="1" data-bbox="863 1337 1353 1612"> <thead> <tr> <th data-bbox="863 1337 991 1370">(0) PC</th> <th data-bbox="991 1337 1353 1370"></th> </tr> </thead> <tbody> <tr> <td data-bbox="863 1370 991 1404">1</td> <td data-bbox="991 1370 1353 1404">WinCC Appl. Client</td> </tr> <tr> <td data-bbox="863 1404 991 1438">2</td> <td data-bbox="991 1404 1353 1438"></td> </tr> <tr> <td data-bbox="863 1438 991 1471">3</td> <td data-bbox="991 1438 1353 1471"></td> </tr> <tr> <td data-bbox="863 1471 991 1505">4</td> <td data-bbox="991 1471 1353 1505"></td> </tr> <tr> <td data-bbox="863 1505 991 1538">5</td> <td data-bbox="991 1505 1353 1538"></td> </tr> <tr> <td data-bbox="863 1538 991 1572">6</td> <td data-bbox="991 1538 1353 1572"></td> </tr> <tr> <td data-bbox="863 1572 991 1606">7</td> <td data-bbox="991 1572 1353 1606"></td> </tr> <tr> <td data-bbox="863 1606 991 1626">o</td> <td data-bbox="991 1606 1353 1626"></td> </tr> </tbody> </table>	(0) PC		1	WinCC Appl. Client	2		3		4		5		6		7		o	
(0) PC																				
1	WinCC Appl. Client																			
2																				
3																				
4																				
5																				
6																				
7																				
o																				
4.	Save and compile via the menu command: "Station > Save and compile...". Close the HW Config																			

4 ES/OS client and OS server

4.3 Step-by-Step configuration

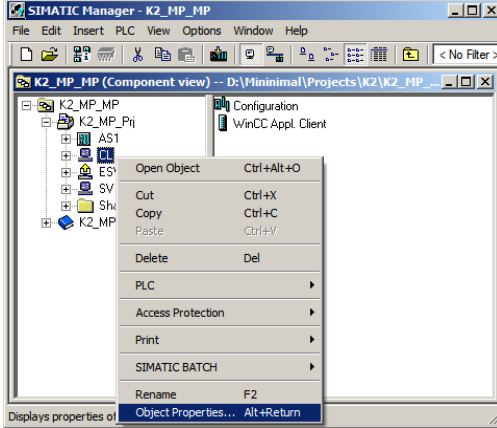
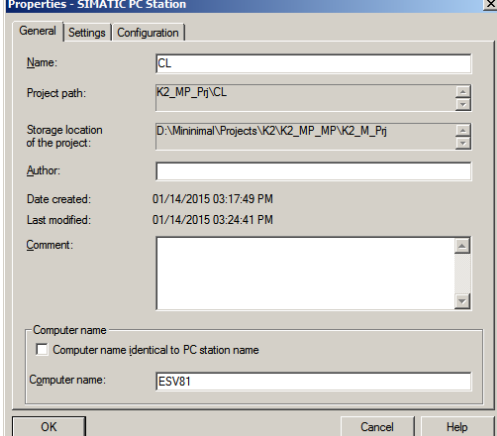
Step	Activity	Screenshot
5.	In SIMATIC Manager, open the shortcut menu of the client's PC station and select "Object properties".	 <p>The screenshot shows the SIMATIC Manager interface with a component view tree. A context menu is open over the 'WinCC Appl. Client' object. The menu items include: Open Object (Ctrl+Alt+O), Cut (Ctrl+X), Copy (Ctrl+C), Paste (Ctrl+V), Delete (Del), PLC, Access Protection, Print, SIMATIC BATCH, Rename (F2), and Object Properties... (Alt+Return). The 'Object Properties...' option is highlighted.</p>
6.	Under "PC name:" enter the name of the PC on which the operation of the client is intended. In the present configuration, this is the ES PC. Click the "OK" button to confirm the entry.	 <p>The screenshot shows the 'Properties - SIMATIC PC Station' dialog box. The 'General' tab is selected. Fields include: Name (CL), Project path (K2_MP_Pj\CL), Storage location of the project (D:\Minimal\Projects\K2\K2_MP_MP\K2_M_Pj), Author, Date created (01/14/2015 03:17:49 PM), Last modified (01/14/2015 03:24:41 PM), and Comment. Under 'Computer name', there is a checkbox for 'Computer name identical to PC station name' (unchecked) and a text field for 'Computer name' containing 'ESV81'. Buttons for OK, Cancel, and Help are at the bottom.</p>

**Configuring all relevant PC stations**

The function "Configure PC station" transfers project configurations to one or more target stations. First configure the local Station Configuration Editor of the ES and then the OS connected to the system bus.

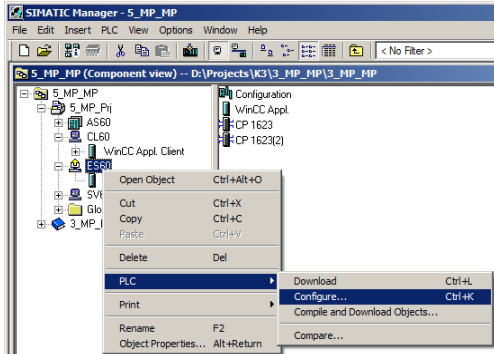
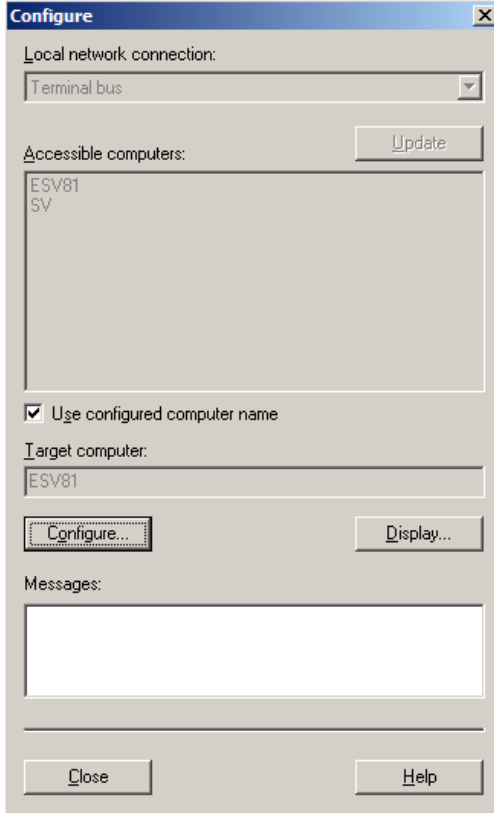
Step	Activity	Screenshot
1.	Configure the Station Configuration Editor of the ES. To do this, open the shortcut menu of the ES and choose "PLC> Configure ...".	
2.	Select the PC to be configured from "Accessible computers:".  <b>NOTE</b> If you have chosen the option "Identical PC name to PC station name" via "Object properties", the target PC to be configured appears directly in the component configurator.  Use the "Show" button to display the current configuration of the PC station. Click on the "Configure..." button.	

4 ES/OS client and OS server

4.3 Step-by-Step configuration

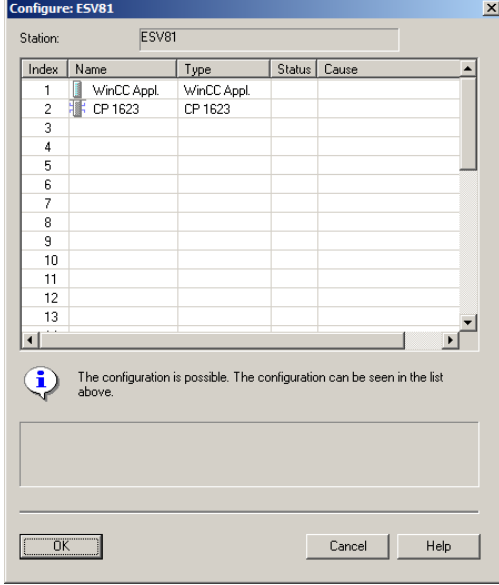
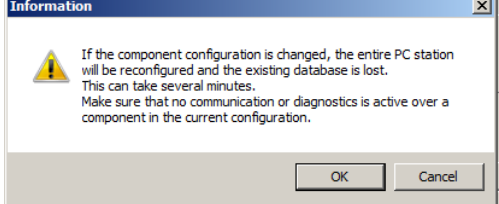
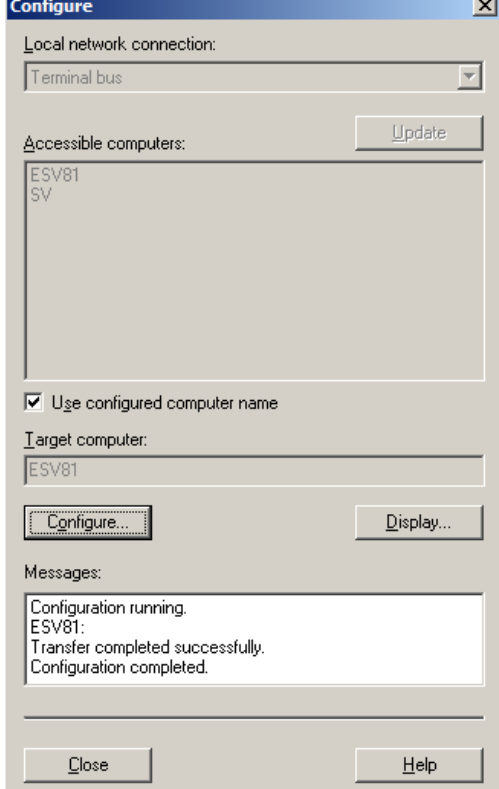
Step	Activity	Screenshot
3.	<p>In the window that appears you will see how the PC station is configured. Click the "OK" button to confirm this setting.</p>	
4.	<p>Confirm the information dialog by clicking the "OK" button.</p>	
5.	<p>In the bottom window you will then see the message: "Transfer completed successfully." Close the configuration dialog.</p>	

## 4 ES/OS client and OS server

### 4.3 Step-by-Step configuration

Step	Activity	Screenshot
6.	Configure the Station Configuration Editor of the OS server as shown in steps 1 to 5.	



### Configuring and loading AS-OS communication

In the following section, the connections between the PC stations and the AS are configured in NetPro and loaded in the individual stations.

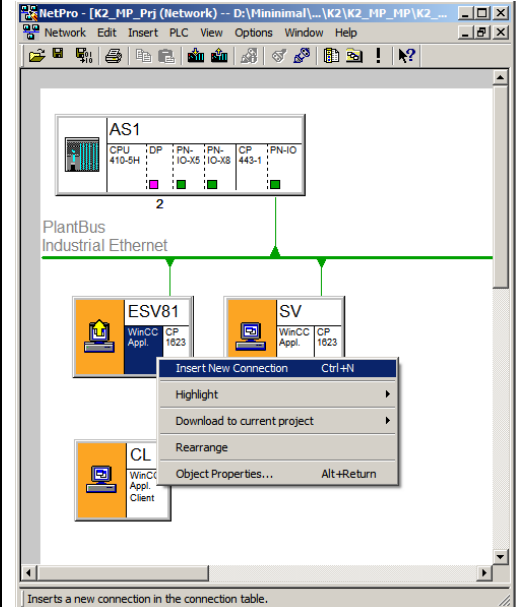
**Note** In case of a granular station configuration, the subnets of the individual sub-projects must be first merged.

Step	Activity	Screenshot
1.	Open NetPro. Select the WinCC application of the ES and open the shortcut menu. Select "Insert New Connection".	

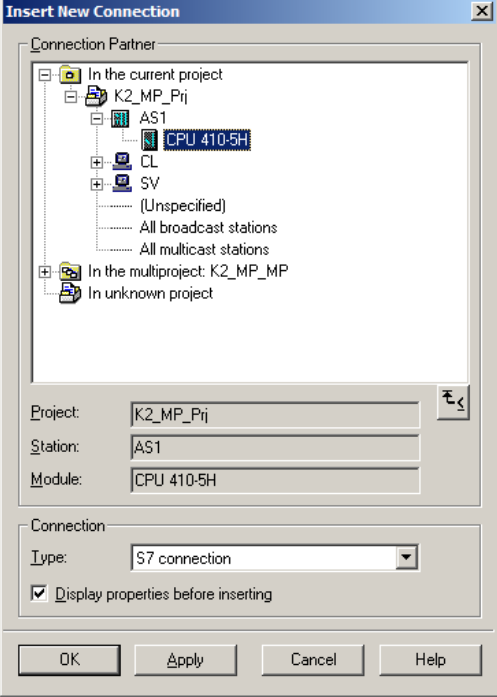
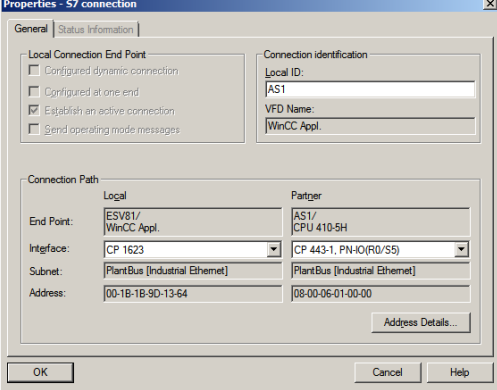
4.3 Step-by-Step configuration

Step	Activity	Screenshot
2.	<p>Select the CPU of the AS in the "Connection Partner" window.</p> <p>Make sure that an "S7 connection" is selected under "Connection".</p> <p>Click the "OK" button to confirm the selection.</p>	
3.	<p>Under "Connection identification" in the "General" tab, change the "Local ID:" to a descriptive name, such as AS1.</p> <p>Click the "OK" button to confirm the entries.</p>	
4.	<p>Repeat steps 1 to 3 for the connection of the OS server to the AS.</p> <p>When doing this, it is important that the connections of the ES and the OS server to the AS have the <b>same name</b>.</p> <p>When ready, save and compile the configuration via the menu command: "Network &gt; Save and Compile...".</p> <p>Select the option button "Compile and check everything" and confirm your selection with the "OK" button.</p>	

## 4 ES/OS client and OS server

### 4.3 Step-by-Step configuration

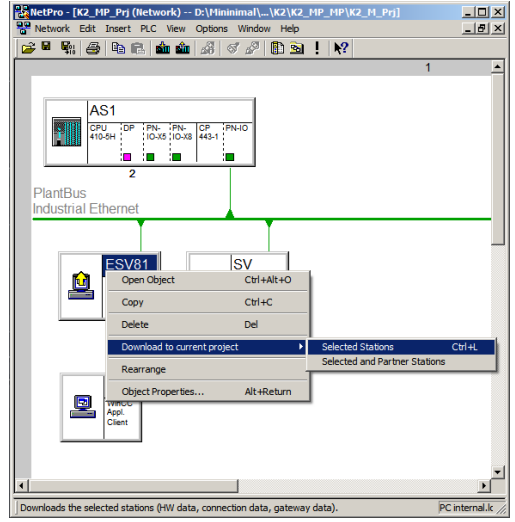
Step	Activity	Screenshot
5.	Select the ES and download the connections via the shortcut menu: "Download to current project > Selected Stations". Download the OS server and the AS in the same way. Then close NetPro.	 The screenshot shows the NetPro software window. At the top, there's a title bar and a menu bar. The main area displays a network diagram with a green line representing the PlantBus Industrial Ethernet. A station labeled 'AS1' is at the top, and 'ESV81' is below it. A context menu is open over the 'ESV81' station, showing options: 'Open Object (Ctrl+Alt+O)', 'Copy (Ctrl+C)', 'Delete (Del)', 'Download to current project' (highlighted), 'Rearrange', and 'Object Properties... (Alt+Return)'. A sub-menu is open under 'Download to current project', showing 'Selected Stations (Ctrl+L)' and 'Selected and Partner Stations'. The status bar at the bottom indicates 'Downloads the selected stations (HW data, connection data, gateway data)'. The bottom right corner shows 'PC internal.k'.

#### Compiling and loading the user program

Compile the S7 program and download it to the AS.

#### Compiling the OS server project

Compile the OS server project in SIMATIC Manager.

Make sure to make the correct OS assignment to the server in the plant view.

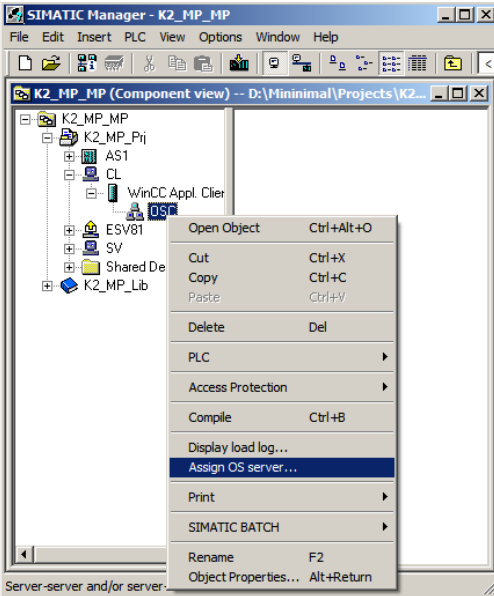
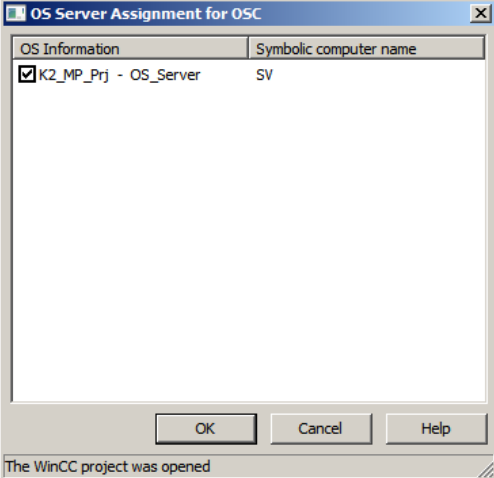
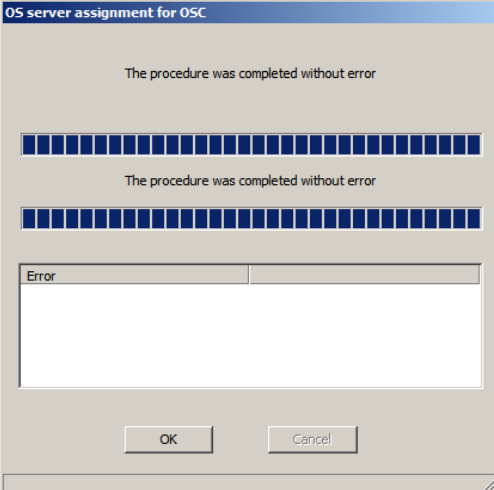

**Assignment of server packages**

Step	Activity	Screenshot
1.	Select the OS application of the OS client and choose "Assign OS server..." in the shortcut menu.	 <p>The screenshot shows the SIMATIC Manager interface. The project tree on the left is expanded to 'WinCC Appl. Clien'. A context menu is open over this node, and the 'Assign OS server...' option is highlighted in blue. Other menu items include 'Open Object', 'Cut', 'Copy', 'Paste', 'Delete', 'PLC', 'Access Protection', 'Compile', 'Display load log...', 'Print', 'SIMATIC BATCH', 'Rename', and 'Object Properties...'.</p>
2.	Select the corresponding OS project and confirm your selection with the "OK" button.	 <p>The screenshot shows the 'OS Server Assignment for OSC' dialog box. It has a table with two columns: 'OS Information' and 'Symbolic computer name'. The first row is checked and contains 'K2_MP_Prj - OS_Server' and 'SV'. At the bottom, there are 'OK', 'Cancel', and 'Help' buttons. A status bar at the bottom indicates 'The WinCC project was opened'.</p>
3.	Confirm successful downloading of the package with the "OK" button.	 <p>The screenshot shows a completion dialog box titled 'OS server assignment for OSC'. It contains two progress bars, each with the text 'The procedure was completed without error' above it. Below the progress bars is an 'Error' field. At the bottom, there are 'OK' and 'Cancel' buttons.</p>

### 4.3.3 OS configuration

#### Activating the time synchronization

On the ES, the necessary settings must still be activated in the OS projects of the OS server and OS client.

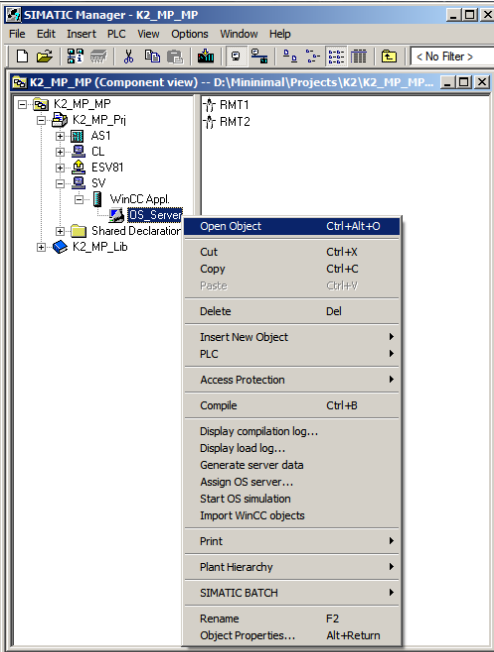
Step	Activity	Screenshot
1.	Open the OS server project.	 <p>The screenshot shows the SIMATIC Manager interface. The project tree on the left is expanded to show the 'OS_Server' folder. A context menu is open over the 'OS_Server' folder, listing various actions such as 'Open Object', 'Cut', 'Copy', 'Paste', 'Delete', 'Insert New Object', 'Access Protection', 'Compile', 'Display compilation log...', 'Display load log...', 'Generate server data', 'Assign OS server...', 'Start OS simulation', 'Import WinCC objects', 'Print', 'Plant Hierarchy', 'SIMATIC BATCH', 'Rename', and 'Object Properties...'. The 'Open Object' option is highlighted at the top of the menu.</p>

4.3 Step-by-Step configuration

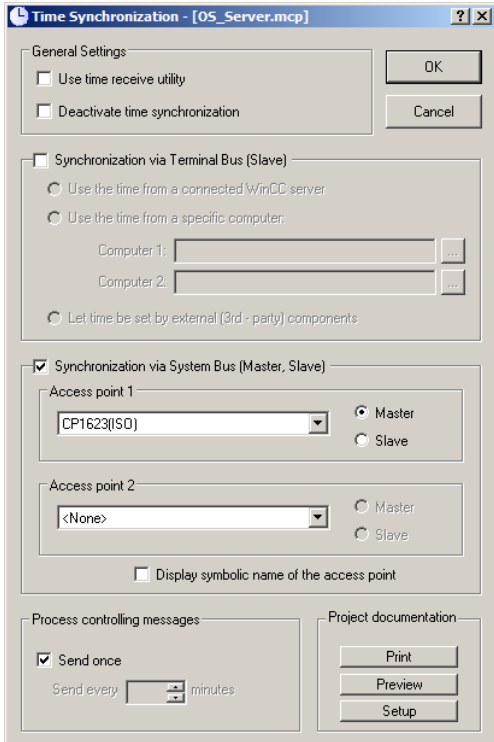
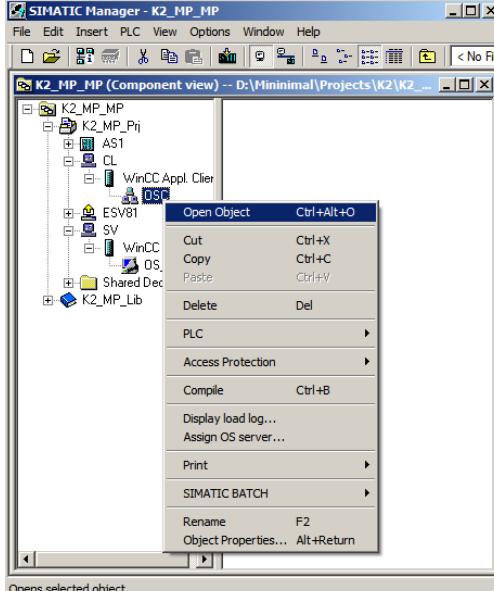
Step	Activity	Screenshot
2.	<p>Open the editor "Time Synchronization" from the shortcut menu.</p> <p>Activate the check box "Synchronization via System Bus (Master, Slave)".</p> <p>Select "CP1623(ISO)" under "Access point 1" and activate the option button "Master".</p> <p>Click the "OK" button to confirm the selection.</p> <p><b>NOTE</b></p> <p>If, in contrast to the OS server, the ES does not have a CP1623, then activate the option "Display symbolic name of the access point" and select the appropriate access point.</p>	
3.	Close the OS server project.	
4.	Open the OS client project.	

## 4 ES/OS client and OS server

### 4.3 Step-by-Step configuration

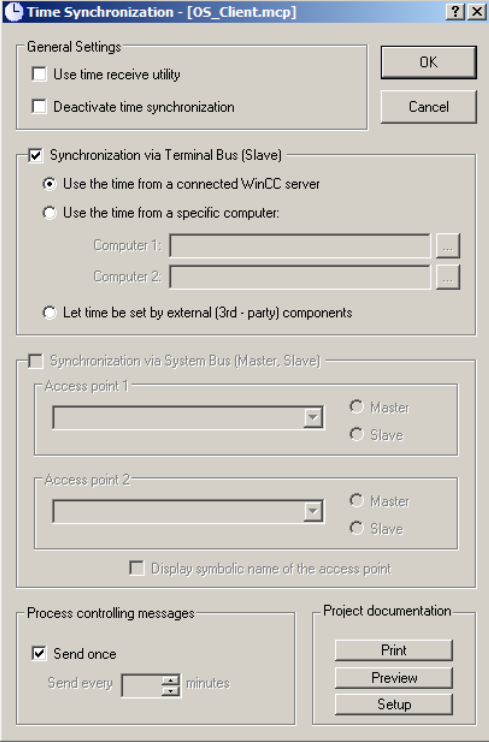
Step	Activity	Screenshot
5.	<p>Open the editor "Time Synchronization" from the shortcut menu.</p> <p>Activate the check box "Synchronization via Terminal Bus (Slave)" and select "Use the time from a connected WinCC server".</p> <p>Click the "OK" button to confirm the selection.</p>	
6.	Close the OS client project.	

**Downloading the OS project to the OS server**

After the time synchronization is configured on the ES side, download the OS project to the OS server.

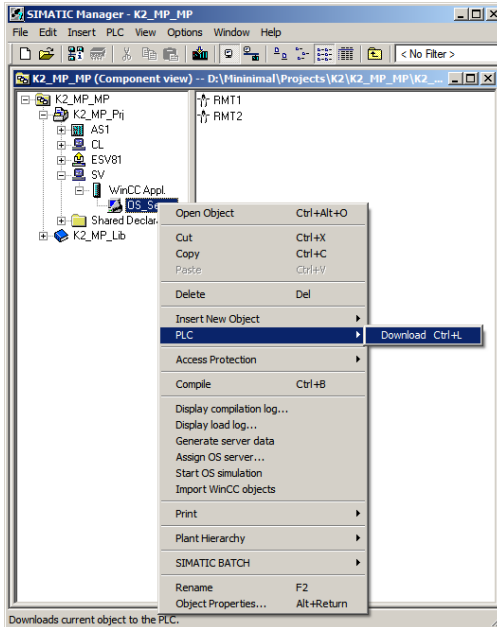
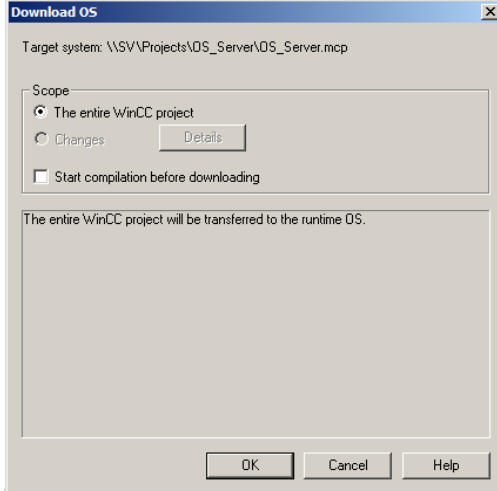
Step	Activity	Screenshot
1.	In SIMATIC Manager, select the OS project of the OS server and select the context menu "PLC > Download".	 <p>The screenshot shows the SIMATIC Manager interface. The 'Component view' on the left displays a project hierarchy including 'K2_MP_MP', 'K2_MP_Pi', 'AS1', 'CL', 'ESV81', 'SV', 'WinCC Appl.', 'Shared Declar.', and 'K2_MP_Lib'. The 'OS_S' project is selected. A context menu is open over the 'OS_S' project, with the 'PLC' option selected and its sub-menu open, showing the 'Download' option (Ctrl+L) highlighted.</p>
2.	For the first OS project download, an entire download is required. Start the download by clicking the "OK" button.	 <p>The screenshot shows the 'Download OS' dialog box. The 'Target system' is set to '\\SV\Projects\OS_Server\OS_Server.mcp'. Under the 'Scope' section, 'The entire WinCC project' is selected with a radio button. There is also an option for 'Changes' with a 'Details' button. A checkbox for 'Start compilation before downloading' is unchecked. A message box states: 'The entire WinCC project will be transferred to the runtime OS.' At the bottom, there are 'OK', 'Cancel', and 'Help' buttons.</p>

## 4 ES/OS client and OS server

### 4.3 Step-by-Step configuration

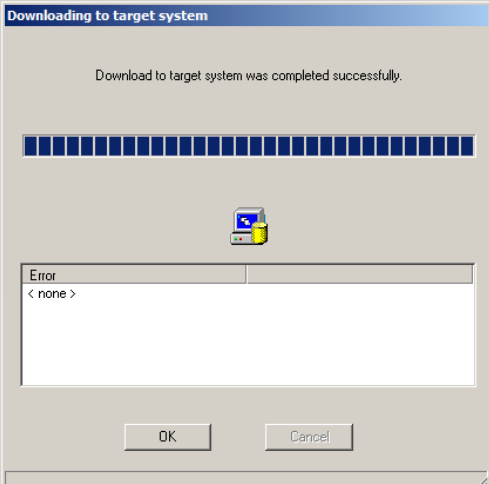
Step	Activity	Screenshot
3.	After a successful download, the OS project is located in the specified folder on the OS server. Click the "OK" button to confirm the corresponding message.	

**OS configuration on the OS server**

The following step instructions for time synchronization must be checked and corrected it if necessary after the first download.

**Note**

Normally, all the engineering work will be carried out on the ES for the purpose of consistent data management, so that no WinCC engineering licenses are required on the OSs. Nevertheless, each time the WinCC Explorer is opened, a licence-free time window of two hours is enabled for WinCC configuration works.

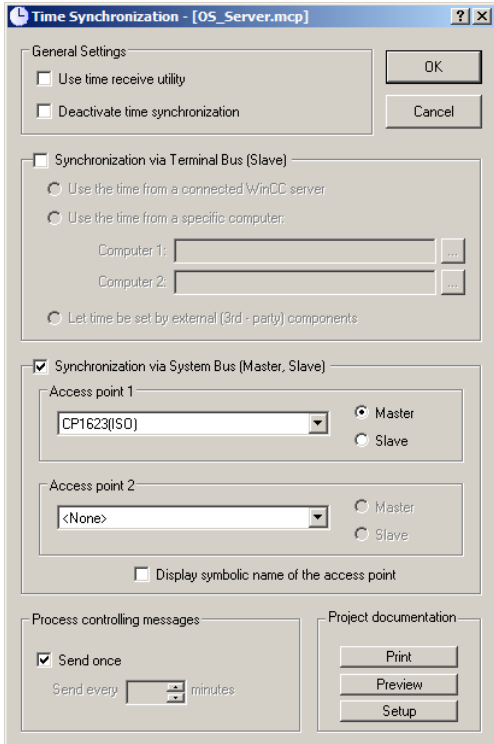
Step	Activity	Screenshot
1.	Open the OS project on the OS server.	
2.	<p>Open the editor "Time Synchronization" from the shortcut menu.</p> <p>Check or activate the check box "Synchronization via System Bus (Master, Slave)".</p> <p>Check or select "CP1623(ISO)" and the option button "Master" under "Access point 1".</p> <p>Click the "OK" button to confirm the settings.</p>	

#### **4.3.4 Activating the runtime**

Open the OS project on the OS server and activate the runtime.

Then switch to the ES computer and open the OS client project. Activate the runtime here too.

#### **4.3.5 Particularities when loading the OS project changes**

##### **Loading changes**

Before being able to carry out OS compiling and downloading to the ES, the OS client runtime must be first deactivated and the OS project closed.

##### **Complete download**

Before being able to carry out OS compiling and downloading from the ES, the OS client runtime and the OS server must be first deactivated and the corresponding OS projects must be closed.



## 5 ES, Master OS and Standby OS

### 5.1 Configuration description

During the process mode, the pair of single stations runs completely parallel and independent from each other. If one of the single stations fails, there is always an equivalent, redundant OS single station available. The single stations monitor each other during the running period and synchronize the project archives as needed. Configuring is done via the ES.

#### Hardware assembly

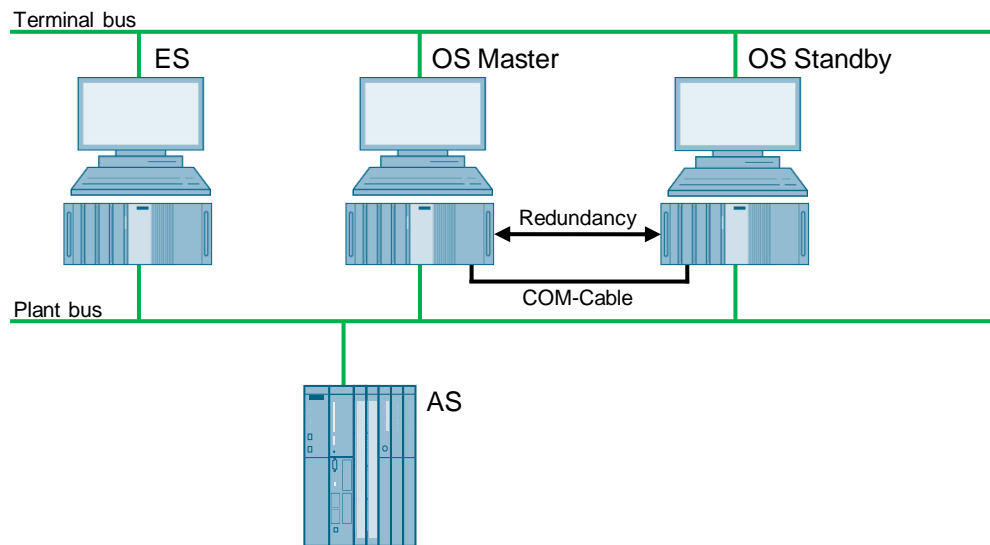

#### NOTE

Server packages are necessary for the functionality of the MS clients. If the OS/MS Server is configured as single station it is not possible to use the MS client on the ES.

The jumping keys in the asset faceplates to HW configuration and to PDM work as follows:

- Up to PDM V8.1: Only on ES
- From PDM V8.2: On ES and OS clients
- From PDM V9.0: On ES, OS clients and web clients

## 5 ES, Master OS and Standby OS

### 5.1 Configuration description

#### PCS 7 configuration

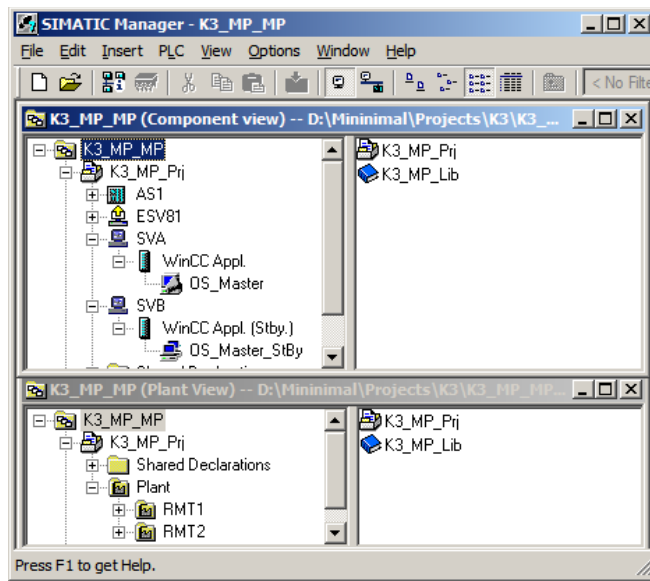

## 5.2 Required hardware and software licensing

### Hardware

The following hardware is recommended for this configuration and can be ordered via the Siemens mall. This ensures that the appropriate amount of operating systems of your choice and SIMATIC PCS 7 system software are pre-installed on the PC stations.

Station	Product label	Operating system	System bus transition
ES	SIMATIC PCS 7 ES/OS IPC847D BCE	Windows 7	RJ45 network card
	SIMATIC PCS 7 ES/OS IPC847D IE	Windows 7	CP 1623
2 x OS Single Station	SIMATIC PCS 7 ES/OS IPC847D BCE	Windows 7	RJ45 network card
	SIMATIC PCS 7 ES/OS IPC847D IE	Windows 7	CP 1623

### Software licensing

The following section lists the software/license packages required for this configuration selection.

Component	Software/license package
ES	<ul style="list-style-type: none"> <li>SIMATIC PCS 7 AS/OS Engineering Software V8.2 (PO unlimited)</li> <li>SIMATIC PCS 7 AS Runtime License</li> </ul>
OS Single Station Redundant	<ul style="list-style-type: none"> <li>SIMATIC PCS 7 OS Software Single Station Redundancy V8.2 (Single License for 2 installations)</li> <li>2x SIMATIC PCS 7 OS Runtime License (max. 5000 PO)</li> </ul>

## 5.3 Step-by-Step configuration

### Note

The following instructions have been created based on Windows 7 and PCS 7 V8.2.

CP1623 are used as an example for the system bus transition. Time synchronization is activated.

The PC stations used in the test setup are called:

- ES: ESV81
- OS server: SVA
- OS-Server Standby: SVB

### 5.3.1 ES configuration

#### Creating the multiproject

As a basis for the following instructions, all PC stations must be physically connected according to the chart in chapter 5.1. A multiproject must be also created on the ES, where the hardware and software of the AS are already configured.

Then you begin from the following CPU and CP settings.

#### AS settings

The analyzability of the process data requires that all the components of the process control system work with an identical clock time in order to be able to assign messages in the correct temporal order.

The following section describes a way in which the redundant OS single stations predetermine the master time.

### Note

More time synchronization possibilities are described in detail in the following manuals:

- [SIMATIC Process Control System PCS 7 Operator Station \(V8.2\)](#)
- [SIMATIC Process Control System PCS 7 Time synchronization \(V8.2\)](#)

## 5 ES, Master OS and Standby OS

### 5.3 Step-by-Step configuration

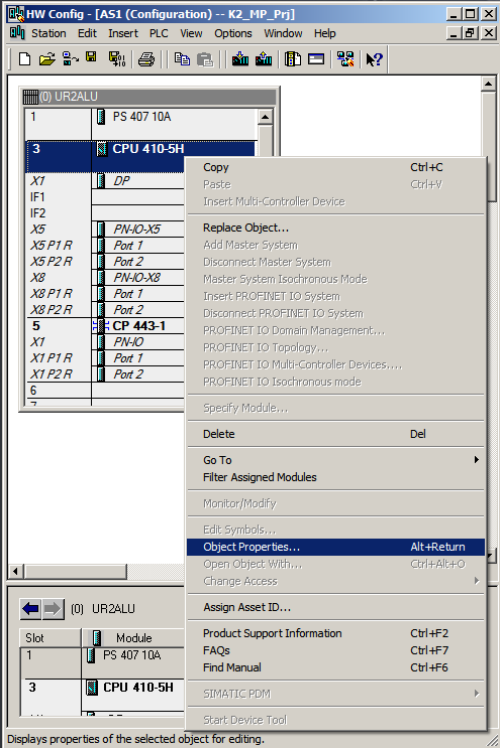
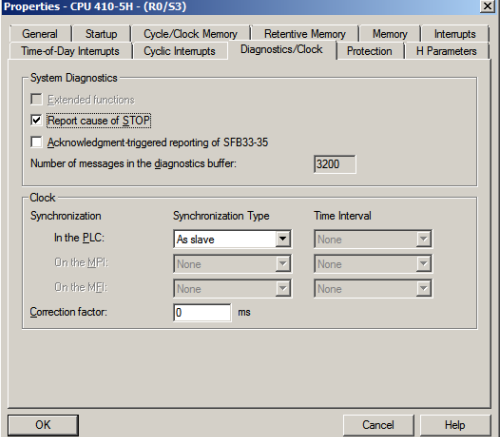
Step	Activity	Screenshot
1.	<p>Open the HW Config for the AS. Select the CPU and choose "Object properties..." in the shortcut menu.</p>	 <p>The screenshot shows the 'HW Config - [AS1 (Configuration)] -- K2_MP_Proj' window. The hardware tree on the left shows 'UR2ALU' with slots 1, 3, 5, and 6. Slot 3 contains 'CPU 410-5H'. A context menu is open over the CPU, with 'Object Properties...' selected. The menu includes options like 'Copy', 'Paste', 'Replace Object...', 'Delete', 'Go To', 'Filter Assigned Modules', 'Monitor/Modify', 'Edit Symbols...', 'Open Object With...', 'Assign Asset ID...', 'Product Support Information', 'FAQs', 'Find Manual', 'SIMATIC PDM', and 'Start Device Tool'.</p>
2.	<p>Switch to the "Diagnostics/Clock" tab. In the "Clock" section, set "Synchronization Type - As slave". Click the "OK" button to confirm the selection.</p>	 <p>The screenshot shows the 'Properties - CPU 410-5H - (R0/S3)' dialog box. The 'Diagnostics/Clock' tab is selected. Under the 'Clock' section, the 'Synchronization Type' is set to 'As slave'. Other settings include 'Number of messages in the diagnostics buffer' set to 3200 and 'Correction factor' set to 0 ms. The 'OK' button is highlighted.</p>

5.3 Step-by-Step configuration

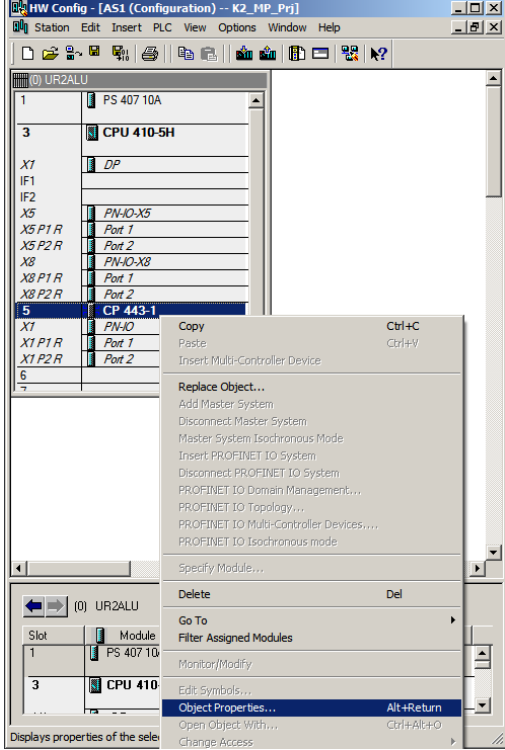
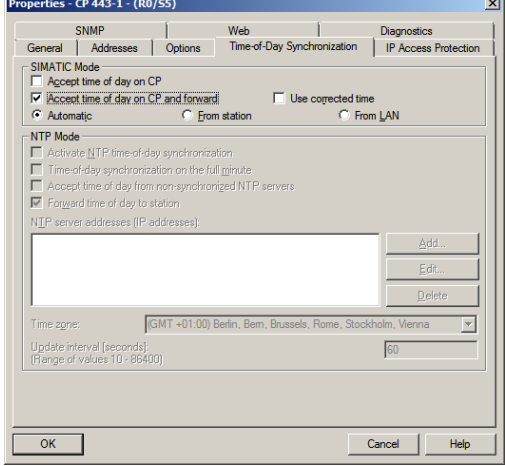
Step	Activity	Screenshot
3.	Open the shortcut menu of the CP and select "Object properties...".	 <p>The screenshot shows the HW Config interface with a context menu open over the CPU 443-1 module. The menu items include Copy, Paste, Replace Object..., Delete, Go To, Filter Assigned Modules, Monitor/Modify, Edit Symbols..., Object Properties... (highlighted), Open Object With..., and Change Access.</p>
4.	Switch to the "Time synchronization" tab. Activate the check box "Accept time of day on CP and forward". Click the "OK" button to confirm the selection.	 <p>The screenshot shows the 'Properties - CP 443-1 - (R0/S5)' dialog box. The 'Time-of-Day Synchronization' tab is active. Under 'SIMATIC Mode', the 'Accept time of day on CP and forward' checkbox is checked. Other options include 'Automatic', 'From station', and 'From LAN'. Under 'NTP Mode', 'Forward time of day to station' is checked. The 'NTP server addresses' field is empty. The 'Time zone' is set to '(GMT +01:00) Berlin, Bern, Brussels, Rome, Stockholm, Vienna' and the 'Update interval [seconds]' is set to 60. The 'OK' button is highlighted.</p>
5.	Save and compile the configuration via: "Station > Save and compile...". Close the HW Config	

**Setting up the ES PC station**

A PC station is created for the ES with the WinCC application to allow testing the OS project on the ES.

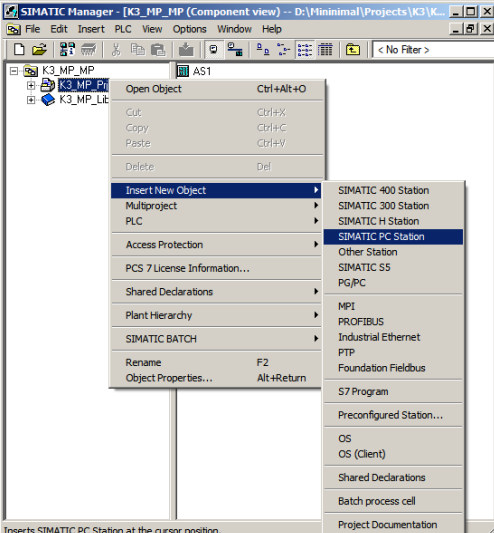
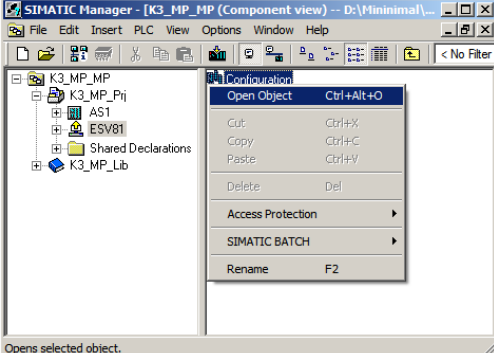
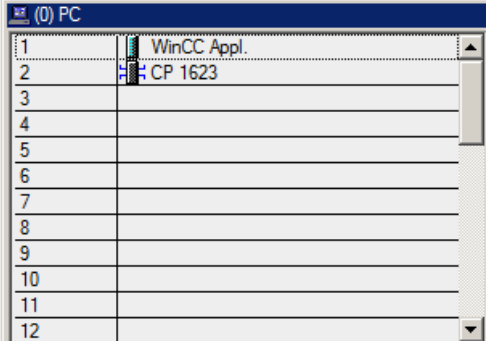
Step	Activity	Screenshot
<p>1.</p>	<p>Open the shortcut menu of the project in the component view and add a new PC station via "Insert New Object &gt; SIMATIC PC station".</p> <p>Change the name of the PC station so that it matches the name of the local computer on the network.</p>	 <p>The screenshot shows the SIMATIC Manager interface with the 'Insert New Object' context menu open. The 'SIMATIC PC Station' option is highlighted. The background shows the project tree with 'K3_MP_MP' selected.</p>
<p>2.</p>	<p>Open the HW Config of the ES PC station via the shortcut menu.</p>	 <p>The screenshot shows the SIMATIC Manager interface with the 'Configuration' context menu open. The 'Configuration' option is highlighted. The background shows the project tree with 'K3_MP_MP' selected.</p>
<p>3.</p>	<p>From the object catalog (View &gt; Catalog) insert a "WinCC application" and a network card of the type "CP1623".</p>	 <p>The screenshot shows the HW Config window for a PC station. It displays a table with 12 slots. Slot 1 contains 'WinCC Appl.' and slot 2 contains 'CP 1623'. The other slots are empty.</p>

5.3 Step-by-Step configuration

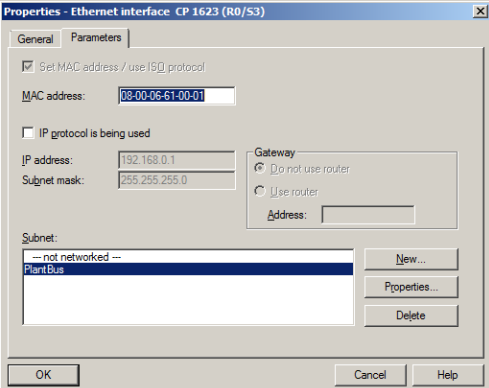
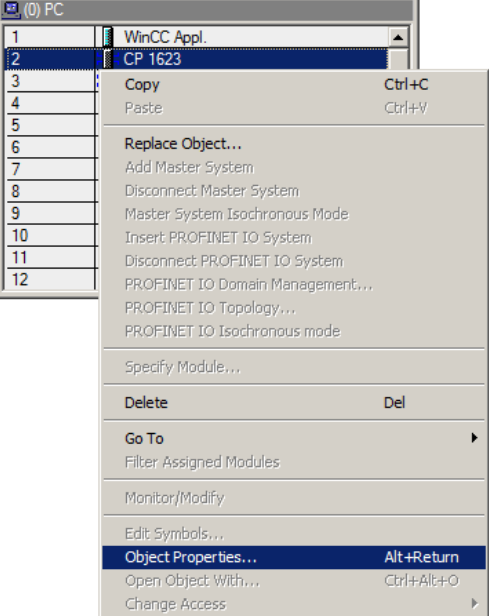
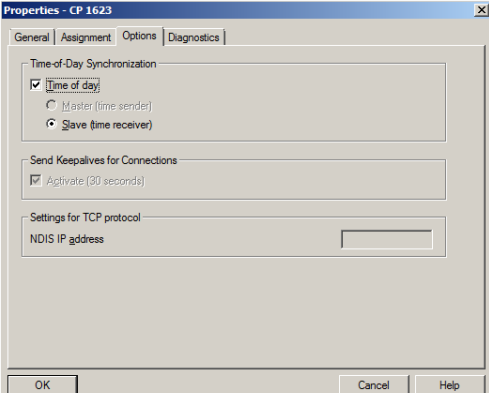
Step	Activity	Screenshot
4.	<p>Select the system bus from "Subnet" or set this by pressing the "New..." button.</p> <p>Assign the corresponding MAC address to the CP1623.</p> <p>Deactivate the check box "IP protocol is being used".</p> <p>Click the "OK" button to confirm the settings.</p>	
5.	<p>Open the shortcut menu of the CP1623 and select "Object properties...".</p>	
6.	<p>Go to the "Options" tab and select the check box "Time of day".</p> <p>Click the "OK" button to confirm the selection.</p>	
7.	<p>Save and compile via the menu command: "Station &gt; Save and compile...".</p> <p>Close the HW Config</p>	
8. optional	<p>Delete the OS of the Engineering Station in SIMATIC Manager, as it is not needed in our example.</p>	

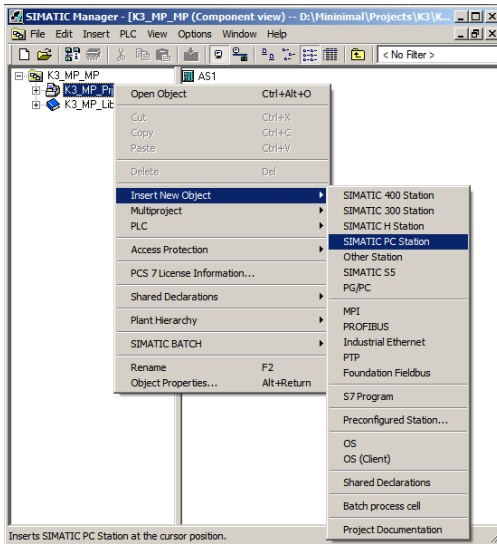
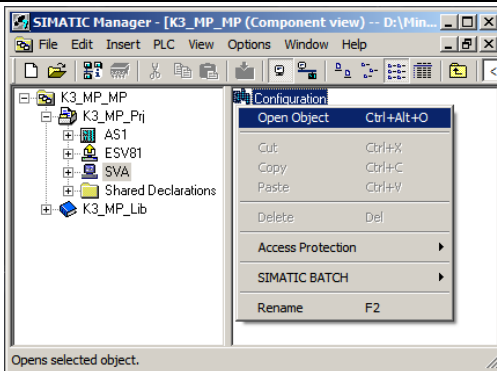
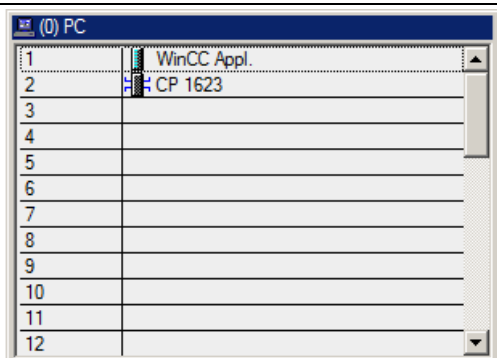

**Setting up the Master OS PC station**

Step	Activity	Screenshot																										
1.	Open the shortcut menu of the project in the component view and add a new PC station via "Insert New Object > SIMATIC PC station".	 <p>The screenshot shows the SIMATIC Manager interface in Component view. A context menu is open over the project tree, with 'Insert New Object' selected. A sub-menu is displayed, showing 'SIMATIC PC Station' as the selected option. Other options include SIMATIC 400 Station, SIMATIC 300 Station, SIMATIC H Station, Other Station, SIMATIC S5, PG/PC, MPI, PROFIBUS, Industrial Ethernet, FTP, Foundation Fieldbus, S7 Program, Preconfigured Station..., OS, OS (Client), Shared Declarations, Batch process cell, and Project Documentation.</p>																										
2.	Open the HW Config of the Master OS PC station via the shortcut menu.	 <p>The screenshot shows the SIMATIC Manager interface with the HW Config window open. The context menu is still visible, but the focus is on the HW Config window, which displays the configuration for the selected object.</p>																										
3.	From the object catalog (View > Catalog) insert a "WinCC application" and a network card of the type "CP1623".	 <p>The screenshot shows the WinCC application configuration window. The 'Configuration' tab is active, and a table lists the components. The first row is 'WinCC Appl.' and the second row is 'CP 1623'. The table has 12 rows in total.</p> <table border="1" data-bbox="869 1332 1348 1646"> <thead> <tr> <th>Row</th> <th>Component</th> </tr> </thead> <tbody> <tr> <td>1</td> <td>WinCC Appl.</td> </tr> <tr> <td>2</td> <td>CP 1623</td> </tr> <tr> <td>3</td> <td></td> </tr> <tr> <td>4</td> <td></td> </tr> <tr> <td>5</td> <td></td> </tr> <tr> <td>6</td> <td></td> </tr> <tr> <td>7</td> <td></td> </tr> <tr> <td>8</td> <td></td> </tr> <tr> <td>9</td> <td></td> </tr> <tr> <td>10</td> <td></td> </tr> <tr> <td>11</td> <td></td> </tr> <tr> <td>12</td> <td></td> </tr> </tbody> </table>	Row	Component	1	WinCC Appl.	2	CP 1623	3		4		5		6		7		8		9		10		11		12	
Row	Component																											
1	WinCC Appl.																											
2	CP 1623																											
3																												
4																												
5																												
6																												
7																												
8																												
9																												
10																												
11																												
12																												

5.3 Step-by-Step configuration

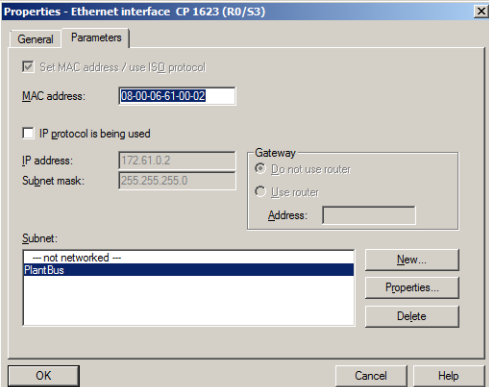
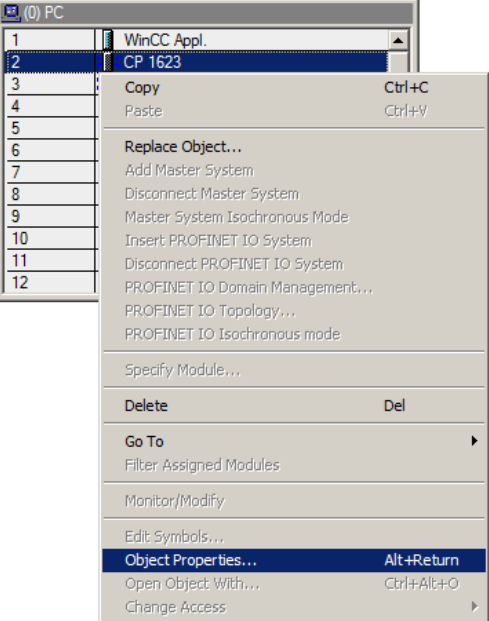
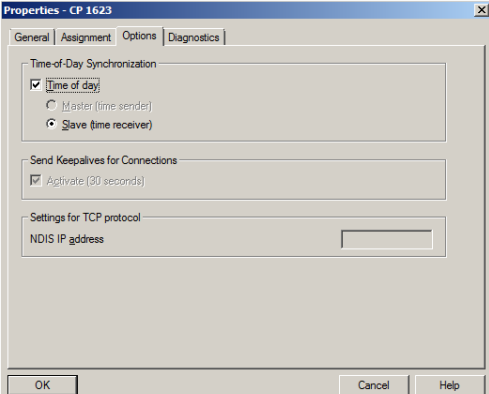
Step	Activity	Screenshot
4.	<p>Select the system bus from "Subnet" or set this by pressing the "New..." button.</p> <p>Assign the corresponding MAC address to the CP1623.</p> <p>Deactivate the check box "IP protocol is being used".</p> <p>Click the "OK" button to confirm the settings.</p>	
5.	<p>Open the shortcut menu of the CP1623 and select "Object properties...".</p>	
6.	<p>Go to the "Options" tab and select the check box "Time of day".</p> <p>Click the "OK" button to confirm the selection.</p>	
7.	<p>Save and compile via the menu command: "Station &gt; Save and compile...".</p> <p>Close the HW Config</p>	

**Setting up the Standby OS PC station**

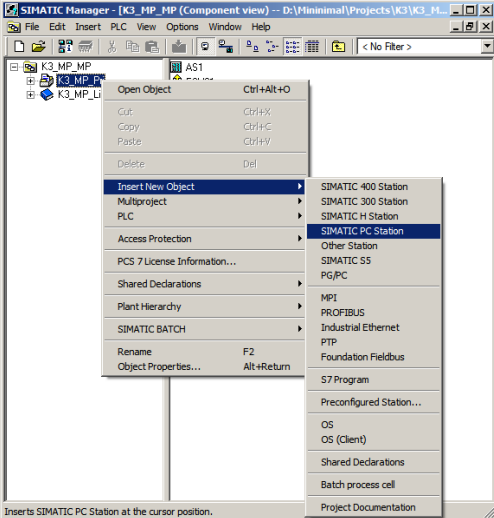
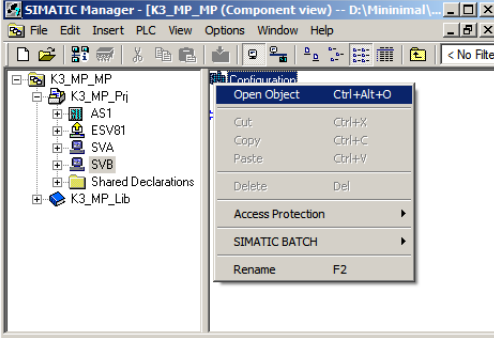
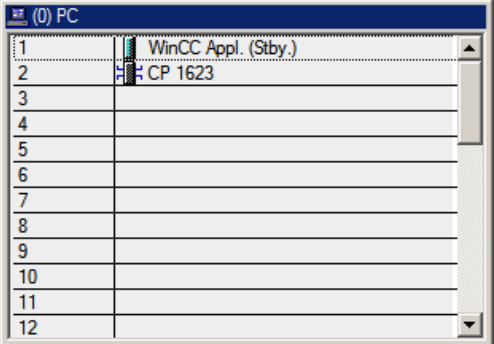
Step	Activity	Screenshot
1.	Open the shortcut menu of the project in the component view and add a new PC station via "Insert New Object > SIMATIC PC station".	 <p>The screenshot shows the SIMATIC Manager interface with the 'Component view' active. A context menu is open over the project tree, and the path 'Insert New Object &gt; SIMATIC PC Station' is highlighted. The status bar at the bottom indicates 'Inserts SIMATIC PC Station at the cursor position.'</p>
2.	Open the HW Config of the Standby OS PC station via the shortcut menu.	 <p>The screenshot shows the SIMATIC Manager interface with the 'Component view' active. A context menu is open over the project tree, and the path 'Open Object &gt; SIMATIC BATCH' is highlighted. The status bar at the bottom indicates 'Opens selected object.'</p>
3.	From the object catalog (View > Catalog) insert a "WinCC application (Stby)" and a network card of the type "CP1623".	 <p>The screenshot shows the WinCC application catalog window. The 'WinCC Appl. (Stby.)' and 'CP 1623' objects are selected in the list. The status bar at the bottom indicates '(0) PC'.</p>

5.3 Step-by-Step configuration

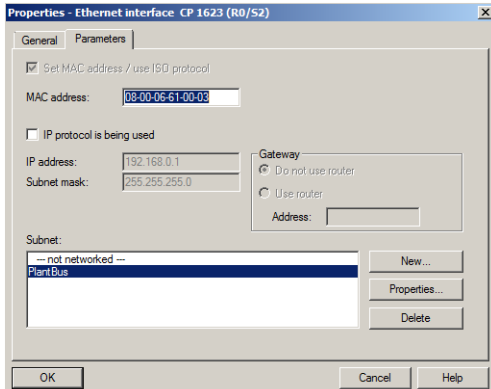
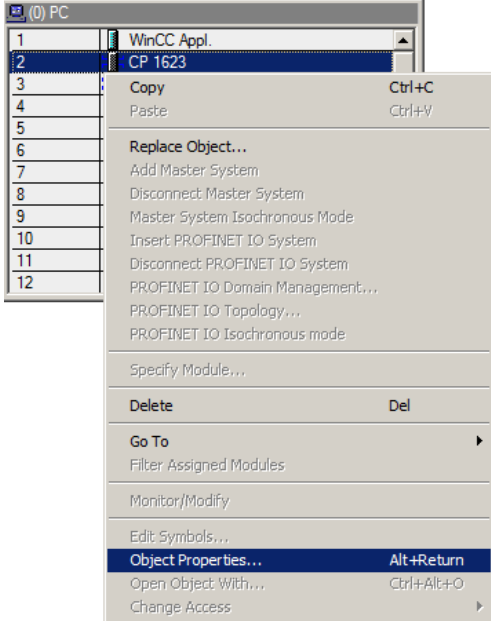
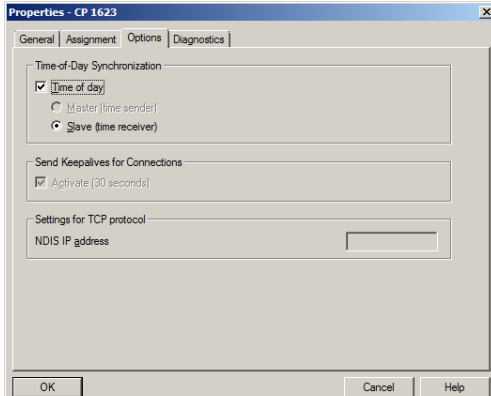
Step	Activity	Screenshot
4.	<p>Select the system bus from "Subnet" or set this by pressing the "New..." button.</p> <p>Assign the corresponding MAC address to the CP1623.</p> <p>Deactivate the check box "IP protocol is being used".</p> <p>Click the "OK" button to confirm the settings.</p>	
5.	<p>Open the shortcut menu of the CP1623 and select "Object properties...".</p>	
6.	<p>Go to the "Options" tab and select the check box "Time of day".</p> <p>Click the "OK" button to confirm the setting.</p>	
7.	<p>Save and compile via the menu command: "Station &gt; Save and compile...".</p> <p>Close the HW Config</p>	

**Configuring all PC stations**

The function "Configure PC station" transfers project configurations to one or more target stations. First, configure the local ES and then all Operator Stations connected to the system bus.

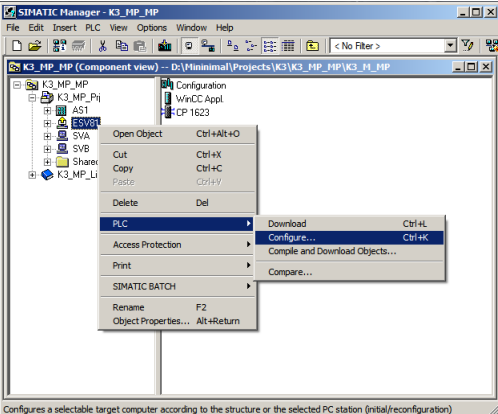
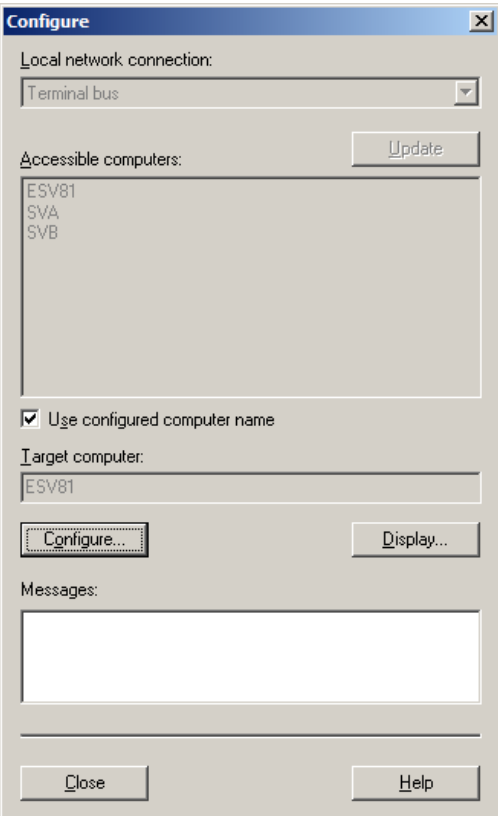
Step	Activity	Screenshot
1.	<p>Configure the Station Configuration Editor of the ES. To do this, select the PC station of the ES and then choose "PLC &gt; Configure..." in the shortcut menu.</p>	 <p>The screenshot shows the SIMATIC Manager interface with a context menu open over a PLC object. The 'Configure...' option is highlighted under the 'PLC' menu item.</p>
2.	<p>Select the PC to be configured from "Accessible computers:".</p> <p><b>NOTE</b> If you have chosen the option "Identical PC name to PC station name" via "Object properties", the target PC to be configured appears directly in the component configurator.</p> <p>Use the "Show..." button to display the current configuration of the PC station. Click on the "Configure..." button.</p>	 <p>The screenshot shows the 'Configure' dialog box. The 'Local network connection' is set to 'Terminal bus'. The 'Accessible computers' list contains 'ESV81', 'SVA', and 'SVB'. The 'Use configured computer name' checkbox is checked, and 'ESV81' is entered in the 'Target computer' field. The 'Configure...' button is highlighted.</p>

5.3 Step-by-Step configuration

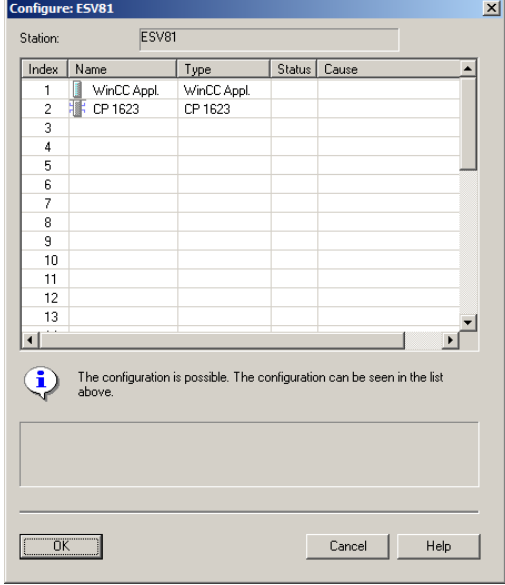
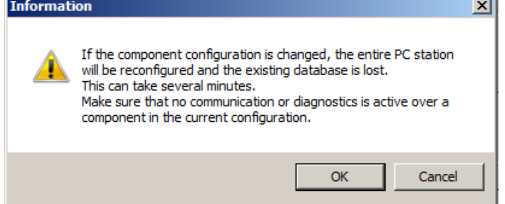
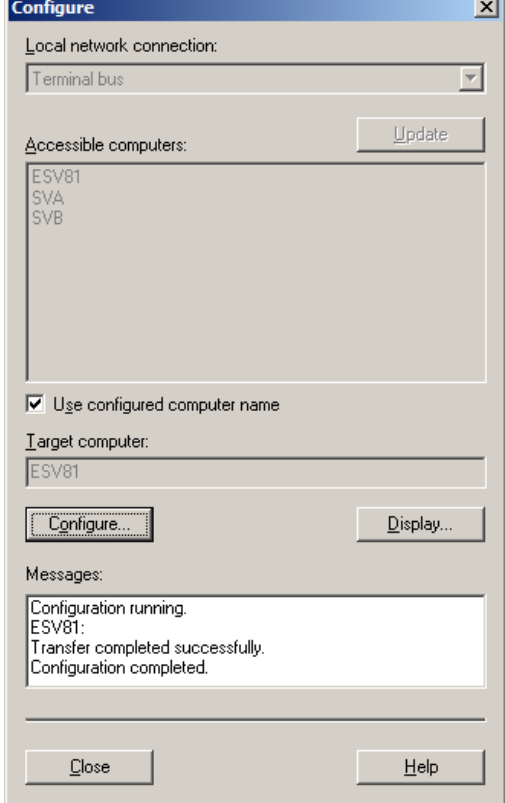
Step	Activity	Screenshot
3.	<p>In the window that appears you will see how the PC station is configured. Click the "OK" button to confirm this setting.</p>	
4.	<p>Confirm the information dialog by clicking the "OK" button.</p>	
5.	<p>In the bottom window you will then see the message: "Transfer completed successfully." Close the configuration dialog.</p>	

5.3 Step-by-Step configuration

Step	Activity	Screenshot
6.	Configure the Station Configuration Editors of the Master/Standby OS as shown in steps 1 to 5.	

**Configuring and loading AS-OS communication**

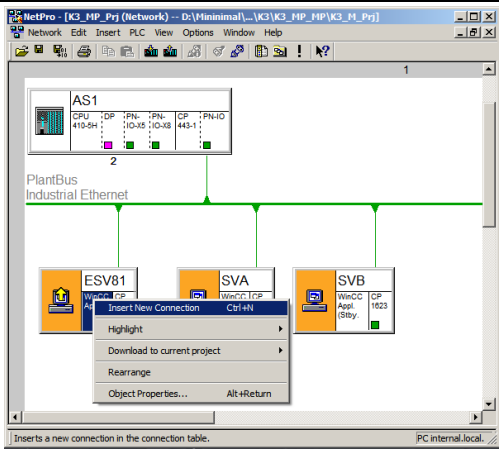
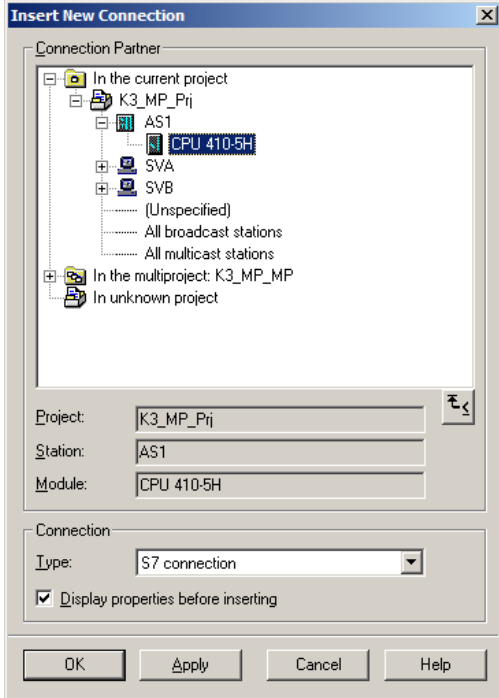

In the following section, the connections between the PC stations and the AS are configured in NetPro and loaded in the individual stations.

**Note** In case of a granular station configuration, the subnets of the individual sub-projects must be first merged.

Step	Activity	Screenshot
1.	Open NetPro. Select the WinCC application of the ES and open the shortcut menu. Select "Insert New Connection".	
2.	Select the CPU of the AS in the "Connection Partner" window. Make sure that an "S7 connection" is selected under "Connection". In this example, a high-availability S7 connection is configured due to the AS configuration. Click the "OK" button to confirm the selection.	

## 5 ES, Master OS and Standby OS

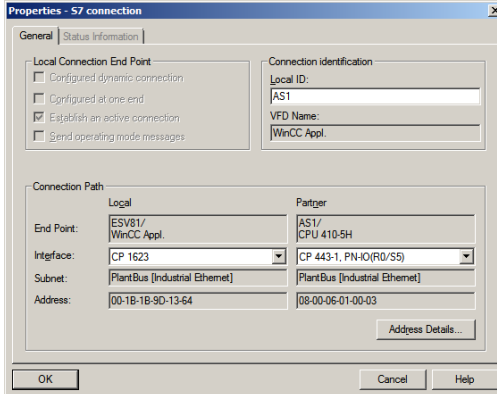
### 5.3 Step-by-Step configuration

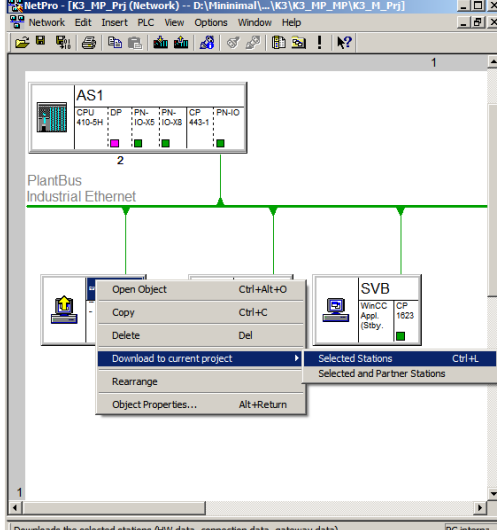
Step	Activity	Screenshot
3.	<p>Under "Connection identification" in the "General" tab, change the "Local ID:" to a descriptive name, such as "AS1".</p> <p>Click the "OK" button to confirm the settings.</p>	
4.	<p>Also set the connections of the Master OS and Standby OS to the AS by repeating steps 1 to 3.</p> <p>When doing this, it is important that the connections of the Master OS, Standby OS and ES to the AS have the same name.</p> <p>Then save and compile the configurations via the menu command: "Network &gt; Save and compile...".</p> <p>Select the option button "Compile and check everything" and confirm your selection by clicking the "OK" button.</p>	
5.	<p>Select the ES and download the connection via the menu command: "Target system &gt; Download to current project &gt; Selected Stations".</p> <p>Download the AS, the Master OS and Standby OS in the same manner.</p> <p>Then close NetPro.</p>	



**Master/Standby settings on the ES**

Here you define the Master/Standby assignment and create the loading paths.

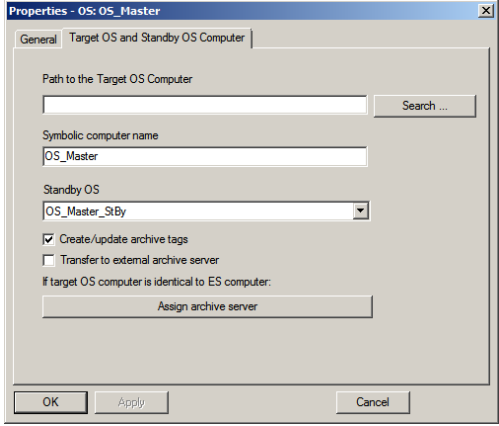
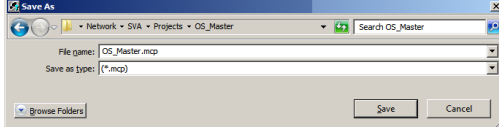
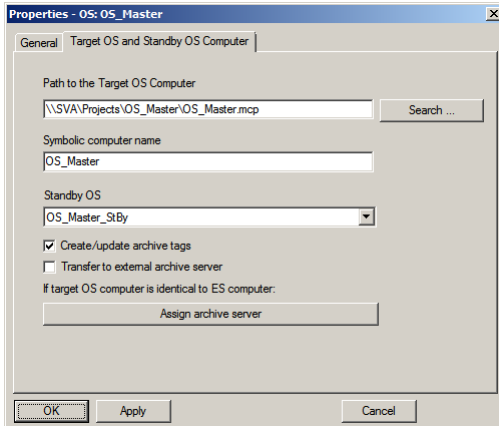
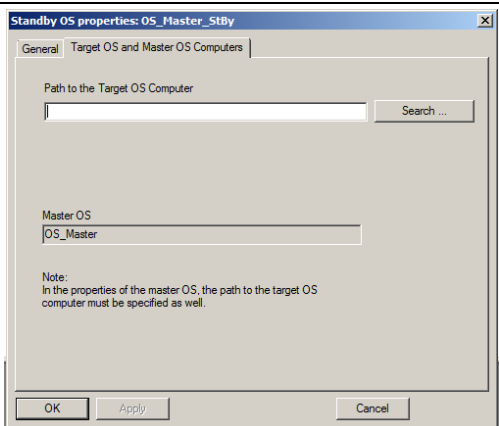
Step	Activity	Screenshot
1.	<p>In SIMATIC Manager, open the properties dialog of the Master OS.</p> <p>Switch to the "Target OS and Standby OS Computer" tab.</p> <p>Select the Standby OS from the drop-down list.</p> <p>Activate the check box "Create/update archive tags".</p> <p>Deactivate the check box "Transfer to external archive server".</p> <p>Click on the "Search..." button.</p>	
2.	<p>Navigate via the drop-down list to the shared project folder of the Master OS (see 4.3.1 Preparatory activities).</p> <p>Click the "Save" button.</p>	
3.	<p>In the text box, reselect the whole project path "Path to Target OS Computer".</p> <p>Click the "OK" button to confirm the entry.</p>	
4.	<p>Open the properties dialog of the Standby OS.</p> <p>Switch to the "Target OS and Mater OS Computers" tab.</p> <p>Check whether OS_Master is entered in the "Master OS" field.</p> <p>Click the "Search..." button to select the file path of the OS data.</p>	

## 5 ES, Master OS and Standby OS

### 5.3 Step-by-Step configuration

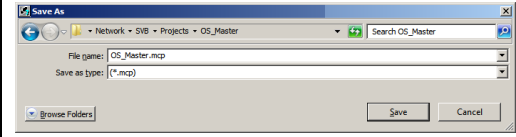
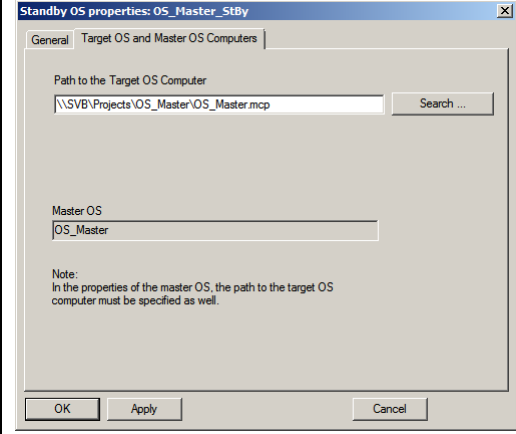
Step	Activity	Screenshot
5.	Navigate via the drop-down list to the shared project folder of the Standby OS (see 4.3.1 Preparatory activities). Click the "Save" button.	
6.	In the text box, select the path "Path to Target OS Computer". Click the "OK" button to confirm this. Confirm the next appearing dialog by clicking "Yes".	

### Compiling and loading the user program

Compile the S7 program and download it to the AS.

### Compiling the OS project

Compile the OS project of the Master OS in SIMATIC Manager.

Make sure to make the correct OS assignment to the server in the plant view.

### 5.3.2 OS configuration

#### OS configuration on the engineering station

On the ES, a conversion must be still done from a multi-user to a single-user system, and the settings for the redundancy and time synchronization must be still adjusted.

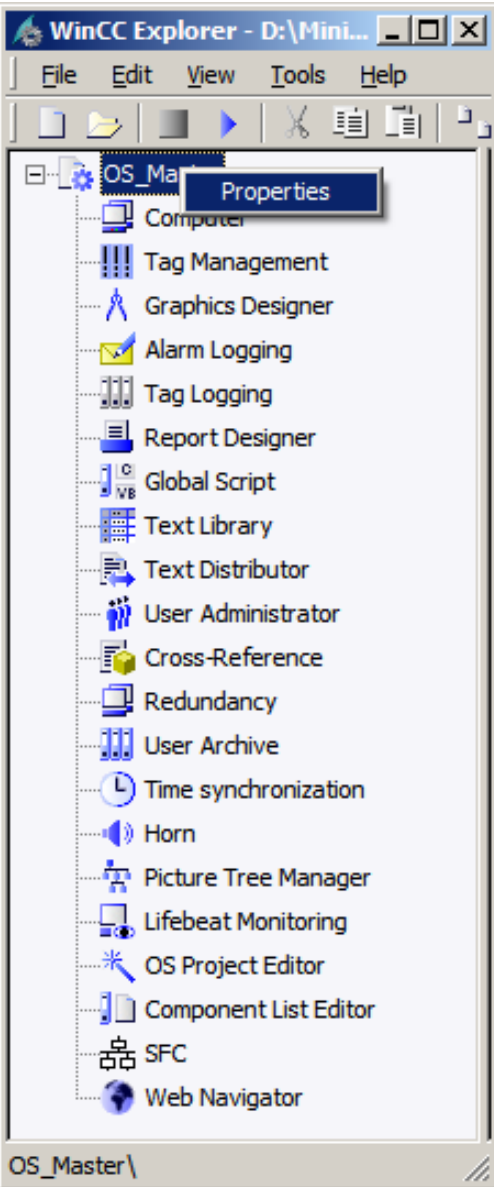
Step	Activity	Screenshot
1.	<p>Open the OS project of the Master OS in the ES.</p> <p>Select the OS project in the open WinCC Explorer and select "Properties" in the shortcut menu.</p>	 <p>The screenshot shows the WinCC Explorer interface. The title bar reads 'WinCC Explorer - D:\Mini...'. The menu bar includes 'File', 'Edit', 'View', 'Tools', and 'Help'. The toolbar contains icons for file operations. The main pane shows a tree view with 'OS_Ma' selected. A context menu is open over 'OS_Ma', with 'Properties' highlighted. Other menu items include 'Computer', 'Tag Management', 'Graphics Designer', 'Alarm Logging', 'Tag Logging', 'Report Designer', 'Global Script', 'Text Library', 'Text Distributor', 'User Administrator', 'Cross-Reference', 'Redundancy', 'User Archive', 'Time synchronization', 'Horn', 'Picture Tree Manager', 'Lifebeat Monitoring', 'OS Project Editor', 'Component List Editor', 'SFC', and 'Web Navigator'. The status bar at the bottom shows 'OS_Master\'.</p>

5.3 Step-by-Step configuration

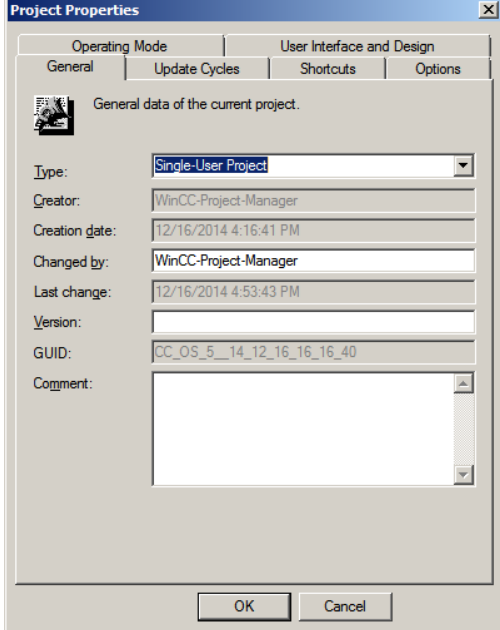
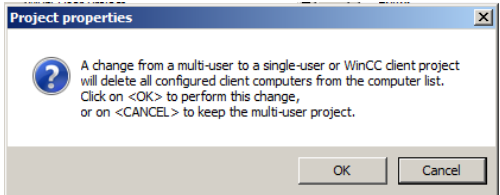
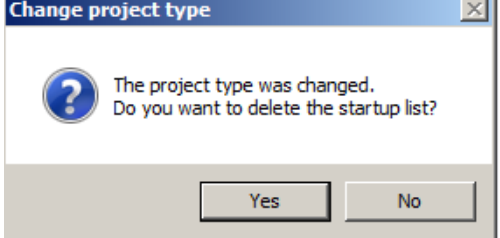
Step	Activity	Screenshot
2.	<p>Under "Type" in the "General" tab, select: "Single-User Project".</p> <p>Confirm your entry and the displayed message by clicking the "OK" button.</p>	 <p>The screenshot shows the 'Project Properties' dialog box with the 'General' tab selected. The 'Type' dropdown menu is set to 'Single-User Project'. Other fields include 'Creator: WinCC-Project-Manager', 'Creation date: 12/16/2014 4:16:41 PM', 'Changed by: WinCC-Project-Manager', 'Last change: 12/16/2014 4:53:43 PM', 'Version:', 'GUID: CC_OS_5_14_12_16_16_40', and a 'Comment' text area. 'OK' and 'Cancel' buttons are at the bottom.</p>  <p>The second screenshot is a warning dialog box titled 'Project properties'. It contains a question mark icon and the text: 'A change from a multi-user to a single-user or WinCC client project will delete all configured client computers from the computer list. Click on &lt;OK&gt; to perform this change, or on &lt;CANCEL&gt; to keep the multi-user project.' 'OK' and 'Cancel' buttons are at the bottom.</p>
3.	<p>Prevent deleting the startup list by clicking the "No" button.</p>	 <p>The screenshot shows a dialog box titled 'Change project type'. It contains a question mark icon and the text: 'The project type was changed. Do you want to delete the startup list?' 'Yes' and 'No' buttons are at the bottom.</p>

5.3 Step-by-Step configuration

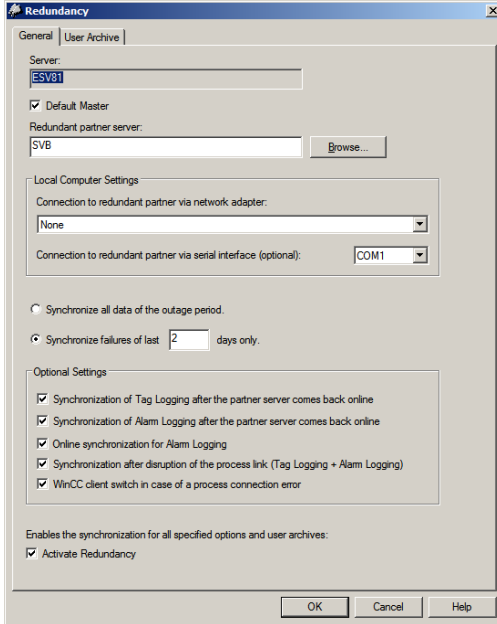
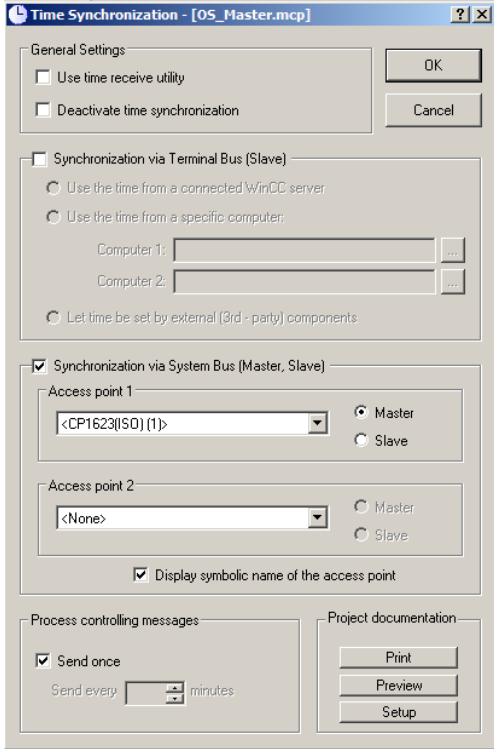
Step	Activity	Screenshot
4.	<p>Open the "Redundancy" editor.</p> <p>Activate the "Default Master" option.</p> <p>Enter the Standby OS in the "Redundant partner server" field.</p> <p>Check whether your desired check boxes are activated under "Optional Settings".</p> <p>If you do not want to operate the RS 232 redundancy cable on the COM1 interface, you must adjust this setting later yourself on the operator stations (see section "OS configuration on the Operator Station").</p> <p>Click the "OK" button to confirm the settings.</p>	
5.	<p>Open the "Time Synchronization" editor.</p> <p>Activate the check box "Synchronization via System Bus (Master, Slave)".</p> <p>Select "CP1623(ISO)" under "Access point 1" and activate the "Master" option.</p> <p>Activate the check box "Display symbolic name of the access point".</p> <p>Click the "OK" button to confirm the settings.</p> <p><b>NOTE</b> If the ES does not have a CP1623, then activate the option "Display symbolic name of the access point" and select the appropriate access point.</p>	
6.	Close the OS project.	

**Downloading the OS project to the OS computer**

Once the redundancy and time synchronization are configured on the ES, download the OS project to the Master OS and the Standby OS.

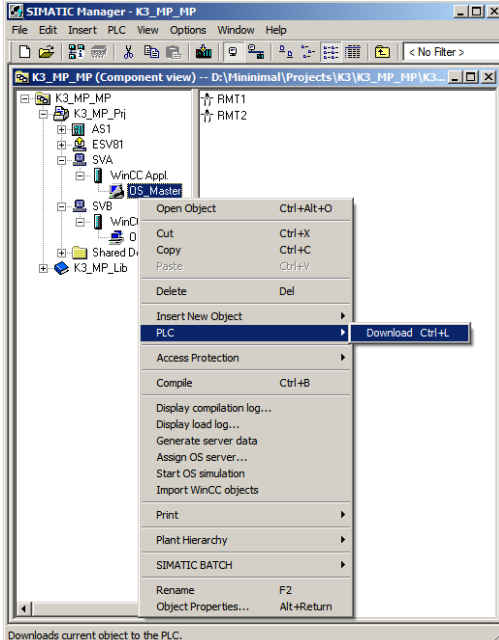
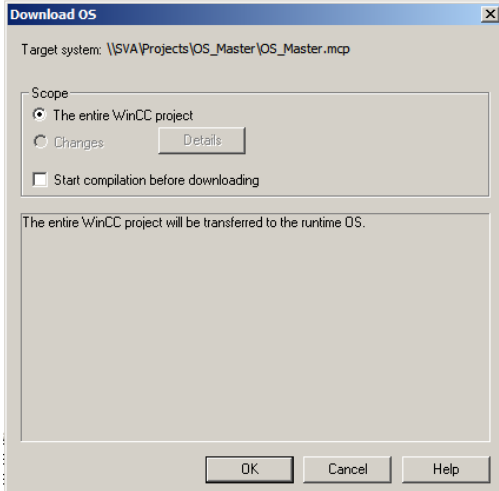
Step	Activity	Screenshot
1.	In SIMATIC Manager, select the Master OS and choose the following in the context menu: "PLC > Download".	 <p>The screenshot shows the SIMATIC Manager interface with the 'Component view' tree on the left. The 'OS_Master' object is selected, and a context menu is open over it. The 'PLC' option is expanded, and 'Download' is highlighted. The status bar at the bottom indicates 'Downloads current object to the PLC.'</p>
2.	For the first OS project download, an entire download is required. Start the download by clicking the "OK" button.	 <p>The screenshot shows the 'Download OS' dialog box. The 'Target system' is set to '\\SVA\Projects\OS_Master\OS_Master.mcp'. Under the 'Scope' section, 'The entire WinCC project' is selected with a radio button. There is an unchecked checkbox for 'Start compilation before downloading'. The dialog box contains a message: 'The entire WinCC project will be transferred to the runtime OS.' and has 'OK', 'Cancel', and 'Help' buttons at the bottom.</p>

## 5 ES, Master OS and Standby OS

### 5.3 Step-by-Step configuration

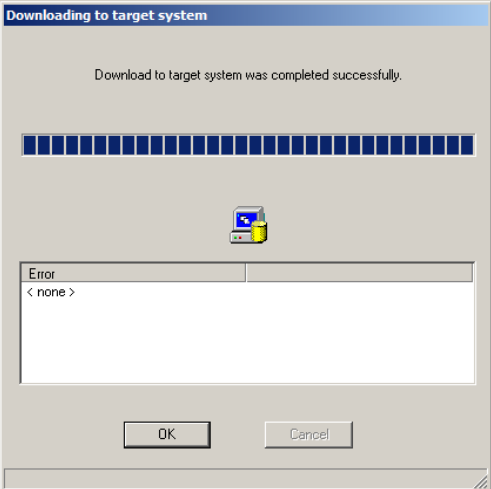
Step	Activity	Screenshot
3.	<p>After a successful download, the OS project is located in the specified folder on the Master OS.</p> <p>Click the "OK" button to confirm the corresponding message.</p>	
4.	<p>Repeat steps 1 to 3 to download the OS project to the Standby OS.</p>	

**Configuring on the Operator Station**

If, as opposed to the operator station, the engineering station has no CP1623 or if the RS 232 redundancy cable is not connected to the COM1 port, the following step instructions must be carried out. Generally we advise you to check the project settings after the project has been downloaded to the target systems.

**Note**

Normally, all the engineering work will be carried out on the ES for the purpose of consistent data management, so that no WinCC engineering licenses are required on the OSs. Nevertheless, each time the WinCC Explorer is opened, a licence-free time window of two hours is enabled for WinCC configuration works.

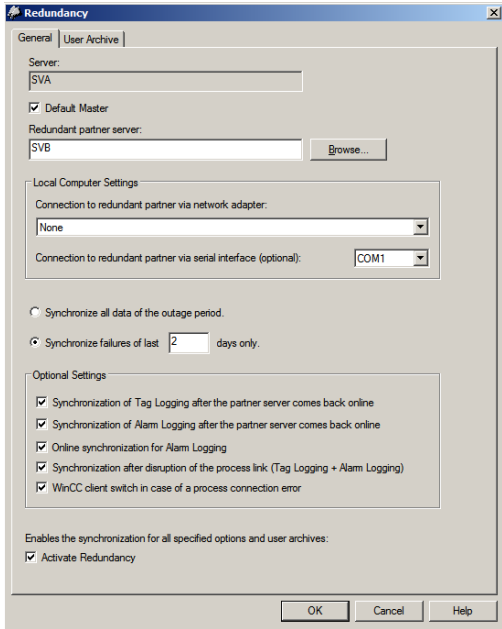
Step	Activity	Screenshot
1.	Open the OS project on the Master OS.	
2.	<p>Open the "Redundancy" editor.                      Check the name of the Master OS in the "Server" field.                      Activate the "Default Master" option.                      Also check whether the name of the Standby OS is entered correctly under "Redundant partner server:".                      Check whether your desired check boxes are activated under "Optional Settings".</p> <p>If you operate the RS 232 redundancy cable on a port which is not the COM1 port, you must set the corresponding port under "Connection to redundant partner via serial interface:".</p> <p>Click the "OK" button to confirm the settings.</p>	

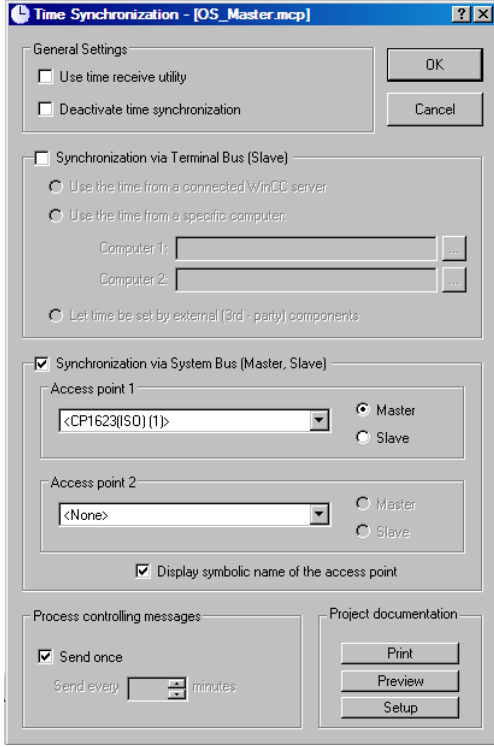
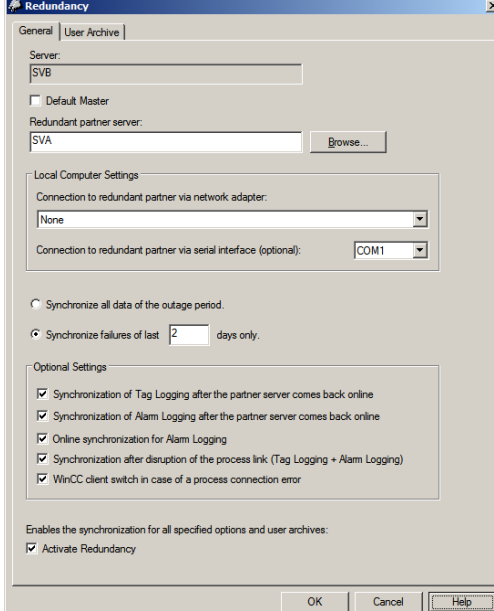

5.3 Step-by-Step configuration

Step	Activity	Screenshot
3.	<p>Open the "Time Synchronization" editor.</p> <p>Check or activate the check box "Synchronization via System Bus (Master, Slave)".</p> <p>Check or select "CP1623(ISO)" and the option button "Master" under "Access point 1".</p> <p>Click the "OK" button to confirm the settings.</p>	
4.	<p>If you have carried out project changes in WinCC Explorer, close the OS project and reopen it for the settings to take effect.</p>	
5.	<p>Repeat steps 1 to 4 on the Standby OS with the following modifications for step 2 (redundancy):</p> <ul style="list-style-type: none"> <li>The check box "Default Master" must be deactivated.</li> <li>Check whether the name of the Master OS is entered correctly under "Redundant partner server:" and change it if required.</li> </ul>	

### **5.3.3 Activating the runtime**

Activate the OS project, first on the Master OS and then on the Standby OS. It is recommended to wait before activating the second runtime until the boot process of the first one has completed.

With regard to redundancy, the online synchronization is immediately active. As opposed to this, the mutual synchronization of archives starts 10 minutes later.

## 6 ES/Master OS and Standby OS

### 6.1 Configuration description

In this configuration with two redundant OS single stations, one of the two stations also serves as a simultaneous ES, which saves the need for a separate third station.

The following two criteria must be observed, which is why we generally recommend creating a configuration with a separate ES (see chapter 5 "ES, Master OS and Standby OS"):

#### Comparatively low saving potential

The saving potential has been reduced since PCS 7 V8.0 because the OS runtime license is not included with the ES license any longer. Therefore, the savings are limited to one computer (hardware and Windows license).

#### Particularities when configuring

The configuration differs from that of the PCS 7 Engineering Standard and represents a kind of workaround.

The "WinCC Application" and "WinCC Standby Application", which are the standard means of PCS 7, cannot be used, as it is not possible to download changes during operation. The mechanisms, that both systems must be in runtime, and that the runtime on the ES must be stopped for the download to proceed, block each other off.

For this reason, we only configure an OS application, open it on both stations and configure their mutual redundancy locally in WinCC. To be able to download to the OS Single Station, the runtime on the ES and the OS must be first closed.

#### NOTICE

This configuration has been tested with a PCS 7 basic installation including the Web Option. No statement can be made regarding the functionality with additional optional packages.

#### NOTE

The jumping keys in the asset faceplates to HW configuration and to PDM work as follows:

- Up to PDM V8.1: Only on ES
- From PDM V8.2: ON ES and OS standby

**Hardware assembly**

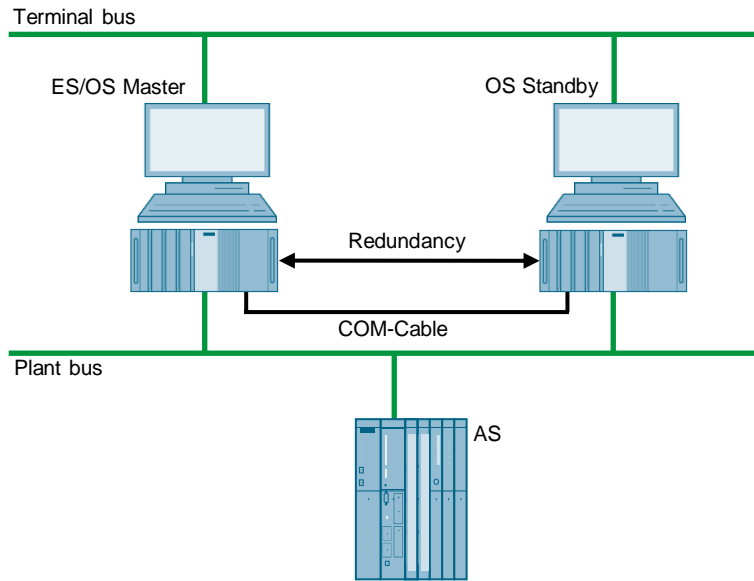

**PCS 7 configuration**

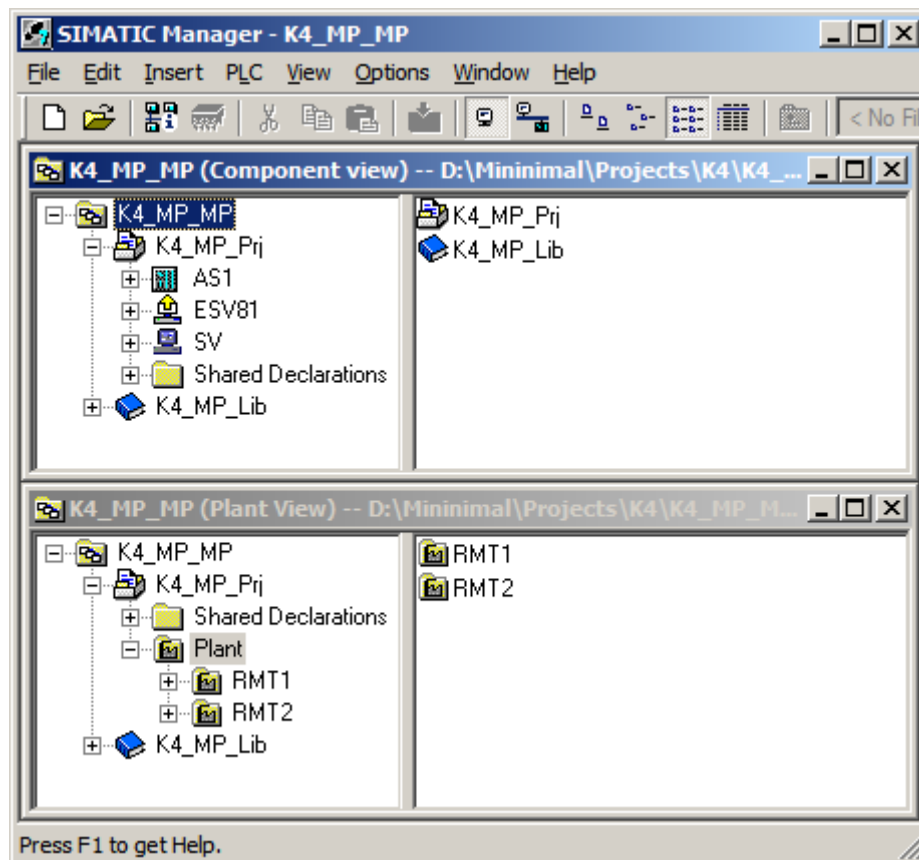

### 6.1 Configuration description

#### Limitations/particularities

Due to the untypical configuration of PCS 7 with only one OS, there are differences in system behavior that must be observed:

- The first activated OS takes over the master role.
- For an entire download to be performed, the runtime must be deactivated and the OS project closed in both computers. During this time, operator actions and archiving are both not possible.
- To download changes, the runtime on the ES must be stopped when compiling the OS. These can be then re-activated to test the modified OS functions. For the downloading process, the runtime must be terminated and the OS Project closed.  
During this time, the operator is restricted from taking any actions on the ES computer.

#### NOTICE

Depending on the changes performed, if the runtime remains active during OS compilation, it can happen that a subsequent downloading of changes is not performed completely, which will cause errors. If this happens, only an entire download is possible.

- When the runtime is active on the ES computer, the runtime archives are stored in the multiproject path. They are incorporated in the ZIP file when archiving and therefore cause an increased demand on memory resources as well as longer archiving times.  
Workaround:
  - Deactivate the runtime on the ES computer
  - Reset the archives in the OS project on the ES computer and close the entire PCS 7 project

After archiving and after re-activating the runtime, the archives are synchronized again. However, it must be noted that more time is needed for synchronization.

## 6.2 Required hardware and software licensing

### Hardware

The following hardware is recommended for this configuration and can be ordered via the Siemens mall. This ensures that the appropriate amount of operating systems of your choice and SIMATIC PCS 7 system software are pre-installed on the PC stations.

Station	Product label	Operating system	System bus transition
ES/OS	SIMATIC PCS 7 ES/OS IPC847D BCE	Windows 7	RJ45 network card
	SIMATIC PCS 7 ES/OS IPC847D IE	Windows 7	CP 1623
OS Single Station	SIMATIC PCS 7 ES/OS IPC847D BCE	Windows 7	RJ45 network card
	SIMATIC PCS 7 ES/OS IPC847D IE	Windows 7	CP 1623

### Software Licensing

The following section lists the software/license packages required for this configuration selection.

Component	Software/licence package
ES	<ul style="list-style-type: none"> <li>SIMATIC PCS 7 AS/OS Engineering Software V8.2 (PO unlimited)</li> <li>SIMATIC PCS 7 AS Runtime License</li> </ul>
OS Single Station Redundant	<ul style="list-style-type: none"> <li>SIMATIC PCS 7 OS Software Single Station Redundancy V8.2 (Single License for 2 installations)</li> <li>2x SIMATIC PCS 7 OS Runtime License (max. 2000 PO)</li> </ul>

## 6.3 Step-by-Step configuration

### Note

The following instructions have been created based on Windows 7 and PCS 7 V8.2.

CP1623 are used as an example for the system bus transition. The time synchronization is additionally activated.

The PC stations used in the test setup are called:

- ES/Master OS: ESV81
- Standby OS: SV

### 6.3.1 ES configuration

#### Creating the multiproject

As a basis for the following instructions, all PC stations must be physically connected according to the chart in chapter 6.1. A multiproject must be also created on the ES, where the hardware and software of the AS are already configured.

Start from the following CPU and CP settings.

#### AS settings for time synchronization

The analyzability of the process data requires that all the components of the process control system work with an identical clock time in order to be able to assign messages in the correct temporal order.

The following section describes a way in which the initially activated OS single station predetermines the master time.

### Note

More time synchronization possibilities are described in detail in the following manuals:

- [SIMATIC Process Control System PCS 7 Operator Station \(V8.2\)](#)
- [SIMATIC Process Control System PCS 7 Time synchronization \(V8.2\)](#)

## 6 ES/Master OS and Standby OS

### 6.3 Step-by-Step configuration

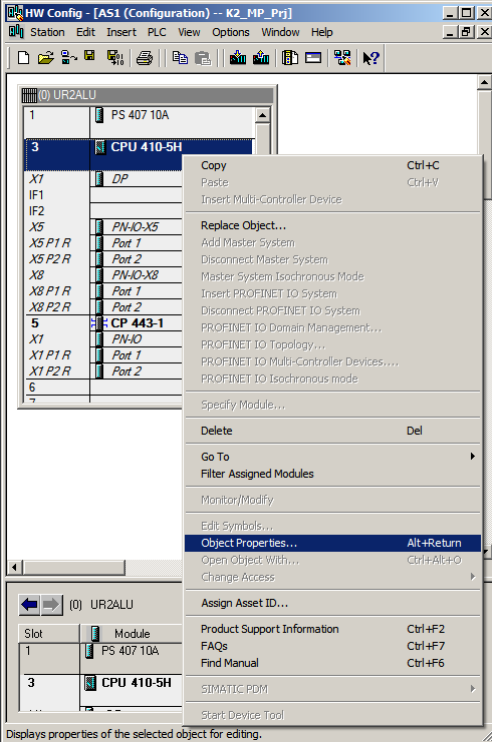
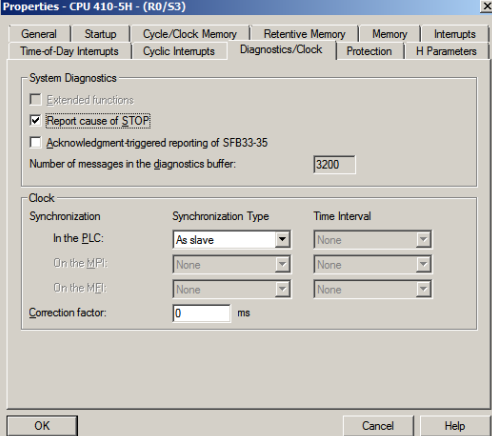
Step	Activity	Screenshot
1.	<p>Open the HW Config for the AS. Select the CPU and choose "Object properties..." in the shortcut menu.</p>	 <p>The screenshot shows the HW Config interface for a rack (UR2ALU). The hardware list includes a PS 407 10A power supply in slot 1 and a CPU 410-5H in slot 3. A context menu is open over the CPU 410-5H, with 'Object Properties...' selected. Other menu items include Copy, Paste, Replace Object..., Delete, and Go To.</p>
2.	<p>Switch to the "Diagnostics/Clock" tab. In the "Clock" section, set "Synchronization Type - As slave". Click the "OK" button to confirm this setting.</p>	 <p>The screenshot shows the 'Properties - CPU 410-5H - (R0/53)' dialog box. The 'Diagnostics/Clock' tab is active. Under the 'Clock' section, the 'Synchronization Type' is set to 'As slave'. Other settings include 'Report cause of STOP' checked and 'Number of messages in the diagnostics buffer' set to 3200.</p>



## 6 ES/Master OS and Standby OS

### 6.3 Step-by-Step configuration

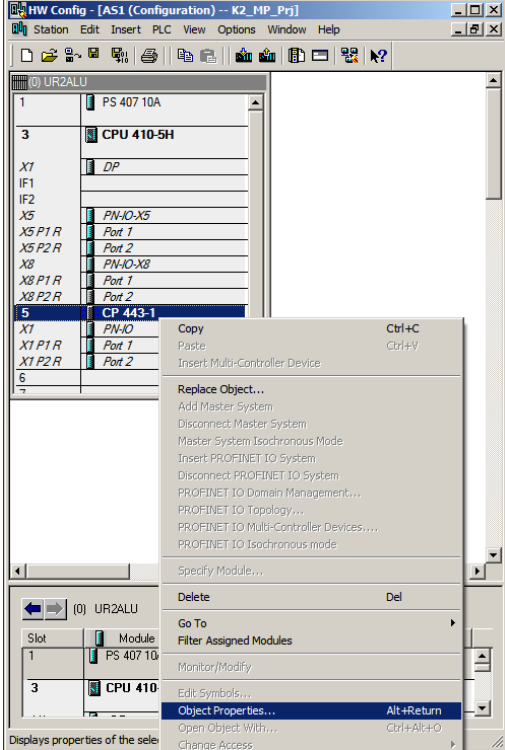
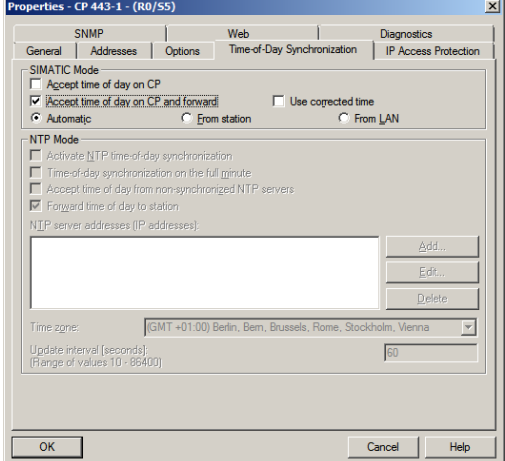
Step	Activity	Screenshot
3.	Open the shortcut menu of the CP and select "Object properties...".	
4.	Switch to the "Time synchronization" tab. Activate the check box "Accept time of day on CP and forward". Click the "OK" button to confirm the selection.	
5.	Save the configuration via the command "Station > Save and compile..." Close the HW Config	

**Setting up the ES PC station**

In order to run the OS project on the ES, a PC station is created for the ES with the WinCC application.

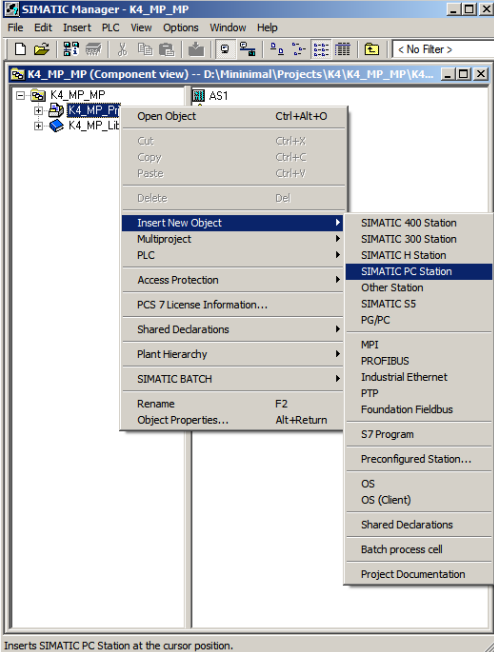
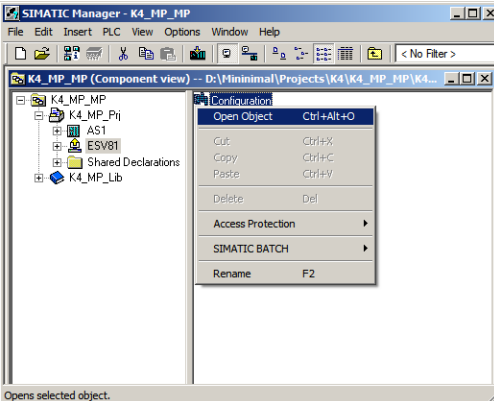
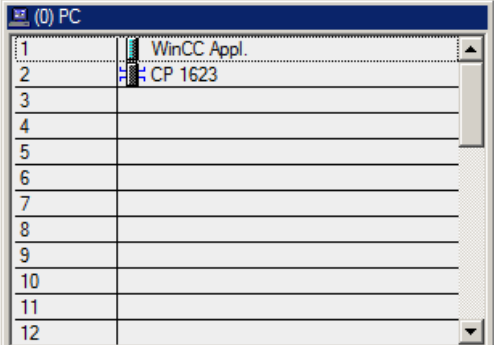
Step	Activity	Screenshot
1.	<p>Open the shortcut menu of the project in the component view and add a new PC station via "Insert New Object &gt; SIMATIC PC station".</p> <p>Change the name of the PC station so that it matches the name of the local computer on the network.</p>	 <p>The screenshot shows the SIMATIC Manager interface with the 'Component view' open. A context menu is displayed over the project tree, with 'Insert New Object' selected. The sub-menu is open, showing 'SIMATIC PC Station' as the selected option. Other options include SIMATIC 400 Station, SIMATIC 300 Station, SIMATIC H Station, Other Station, SIMATIC S5, PG/PC, MPI, PROFIBUS, Industrial Ethernet, PTP, Foundation Fieldbus, S7 Program, Preconfigured Station..., OS, OS (Client), Shared Declarations, Batch process cell, and Project Documentation.</p>
2.	<p>Open the HW Config of the ES PC station via the shortcut menu.</p>	 <p>The screenshot shows the SIMATIC Manager interface with the 'Component view' open. The newly added PC station is selected in the project tree. A context menu is displayed over it, with 'Configuration' selected. Other options include Open Object, Cut, Copy, Paste, Delete, Access Protection, SIMATIC BATCH, and Rename.</p>
3.	<p>From the object catalog ("View &gt; Catalog") insert a "WinCC application" and a network card of the type "CP1623".</p>	 <p>The screenshot shows the HW Config window for the PC station. The 'Object Catalog' is open, and a 'WinCC Appl.' and a 'CP 1623' network card are visible in the configuration table. The table has 12 rows, with the first two rows containing the WinCC application and the CP 1623 card.</p>

## 6 ES/Master OS and Standby OS

### 6.3 Step-by-Step configuration

Step	Activity	Screenshot
4.	<p>Select the system bus from "Subnet" or set this by pressing the "New..." button.</p> <p>Assign the corresponding MAC address to the CP1623.</p> <p>Deactivate the check box "IP protocol is being used".</p> <p>Click the "OK" button to confirm the settings.</p>	
5.	<p>Open the shortcut menu of the CP1623 and select "Object properties..."</p>	
6.	<p>Go to the "Options" tab and select the check box "Time of day".</p> <p>Click the "OK" button to confirm the selection.</p>	
7.	<p>Save and compile the configuration via the menu command: "Station &gt; Save and Compile...".</p> <p>Close the HW Config</p>	
8.	<p>Delete the OS of the PC station of the ES in SIMATIC Manager, as it is not needed in our example.</p>	

Setting up the Standby OS PC station

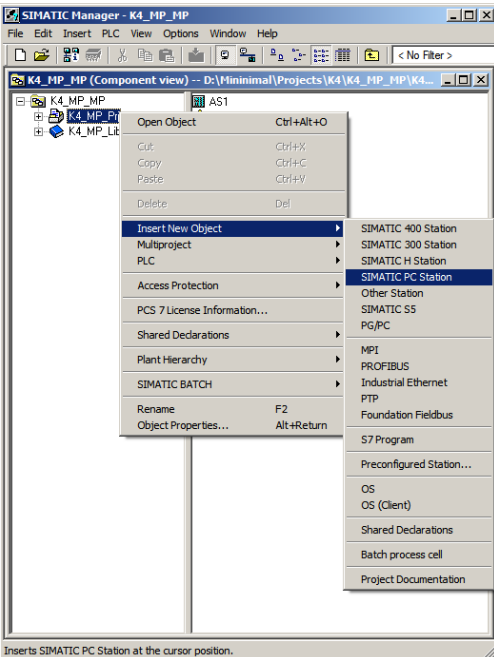
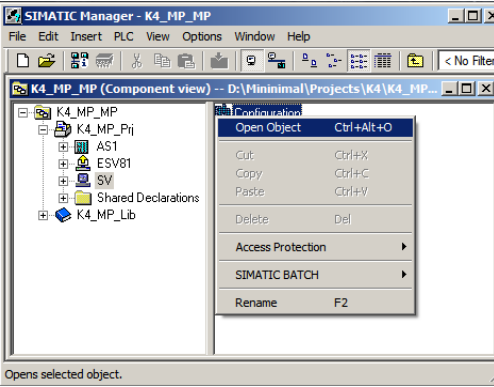
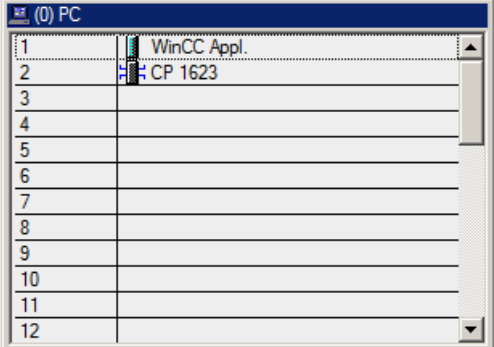
Step	Activity	Screenshot
1.	Open the shortcut menu of the project in the component view and add a new PC station via "Insert New Object > SIMATIC PC station".	
2.	Open the HW Config of the Standby OS PC station via the shortcut menu.	
3.	From the object catalog (View > Catalog) insert a "WinCC application (no WinCC Application Stby!)" and a network card of the type "CP1623".	

## 6 ES/Master OS and Standby OS

### 6.3 Step-by-Step configuration

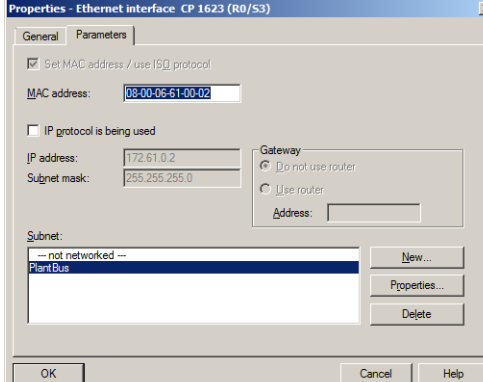
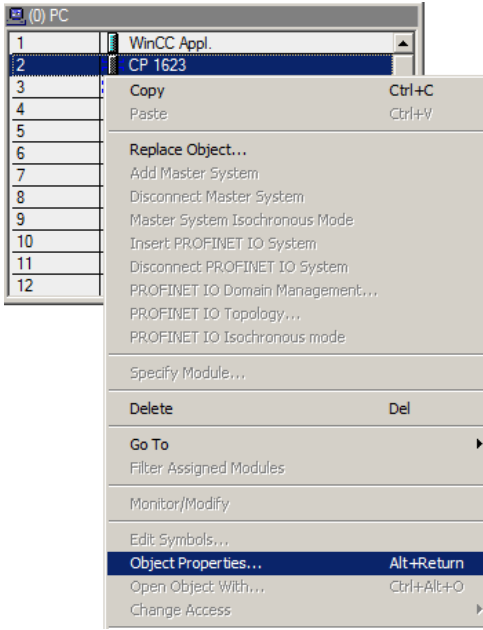
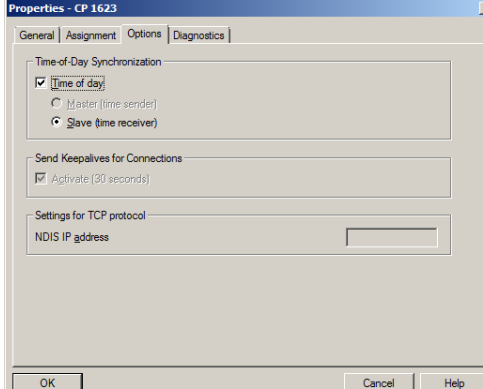
Step	Activity	Screenshot
4.	<p>Select the system bus from "Subnet" or set this by pressing the "New..." button.</p> <p>Assign the corresponding MAC address to the CP1623.</p> <p>Deactivate the check box "IP protocol is being used".</p> <p>Click the "OK" button to confirm the settings.</p>	
5.	<p>Open the shortcut menu of the CP1623 and select "Object properties...".</p>	
6.	<p>Go to the "Options" tab and select the check box "Time of day".</p> <p>Click the "OK" button to confirm the setting.</p>	
7.	<p>Save and compile via the command: "Station &gt; Save and Compile...".</p> <p>Close the HW Config</p>	

## 6 ES/Master OS and Standby OS

### 6.3 Step-by-Step configuration

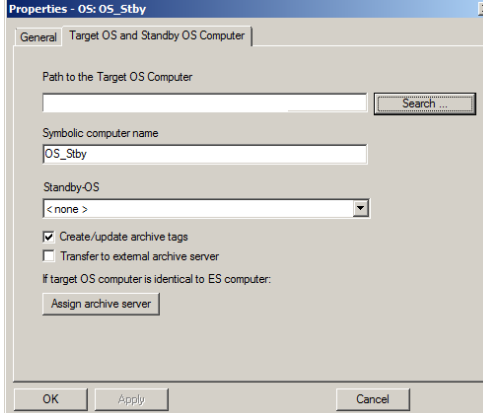
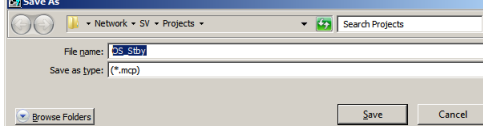
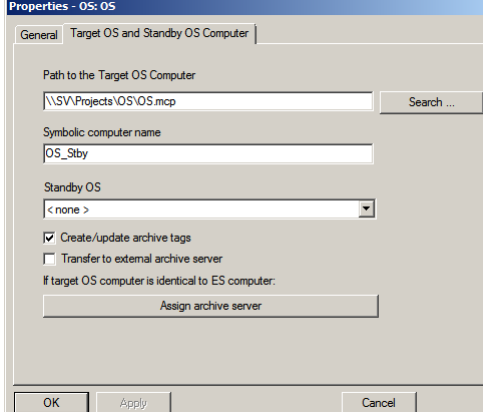
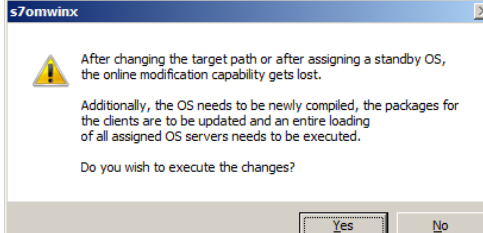
Step	Activity	Screenshot
8.	<p>In SIMATIC Manager, open the properties dialog of the Standby OS.</p> <p>Switch to the "Target OS and Standby OS Computer" tab.</p> <p>Activate the check box "Create/update archive tags" and deactivate the check box "Transfer to external archive server".</p> <p>Click on the "Search..." button.</p>	
9.	<p>Navigate via the drop-down list to the shared project folder of the Standby OS (see 5.3.1 Preparatory activities).</p> <p>Click the "Save" button.</p>	
10.	<p>In the text box, reselect the whole project path "Path to Target OS Computer".</p> <p>Click the "OK" button to confirm this.</p>	
11.	<p>Confirm the information dialog by clicking the "Yes" button.</p>	

**Configuring the PC stations**

The function "Configure PC station" transfers project configurations to one or more target stations. First configure the local Station Configuration Editor of the ES and then all the other PC stations connected to the system bus.

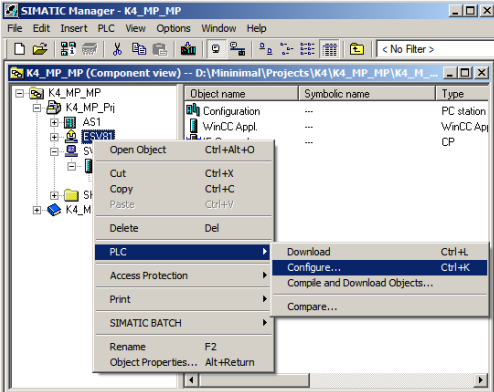
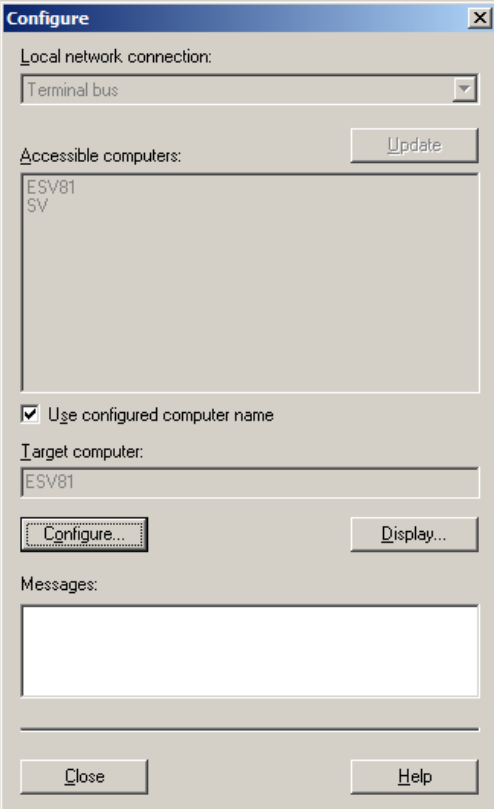
Step	Activity	Screenshot
1.	<p>Execute the Station Configuration Editor of the ES. To do this, select the PC station of the ES and in the shortcut menu choose: "PLC &gt; Configure...".</p>	 <p>Configures a selectable target computer according to the structure or the selected PC station (initial/reconfig)</p>
2.	<p>Select the PC to be configured from "Accessible computers:".</p> <p><b>Note</b> If you have chosen the option "Identical PC name to PC station name" via "Object properties", the target PC to be configured appears directly in the component configurator.</p> <p>Use the "Show" button to display the current configuration of the PC station. Click on the "Configure..." button.</p>	

6.3 Step-by-Step configuration

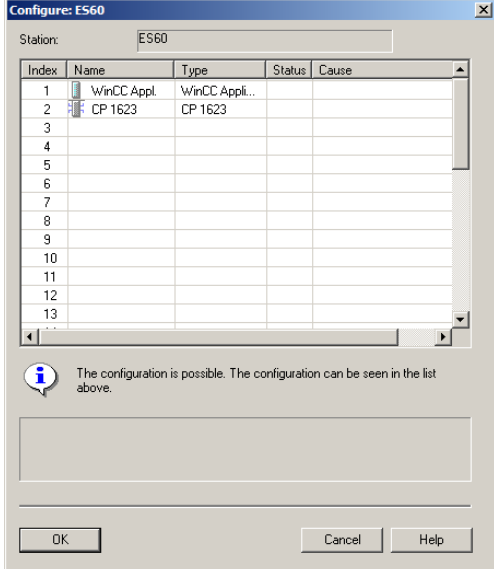
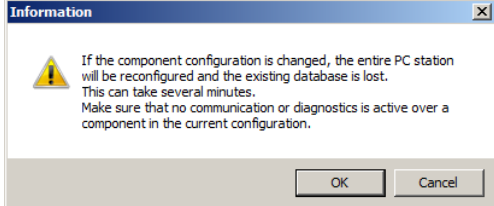
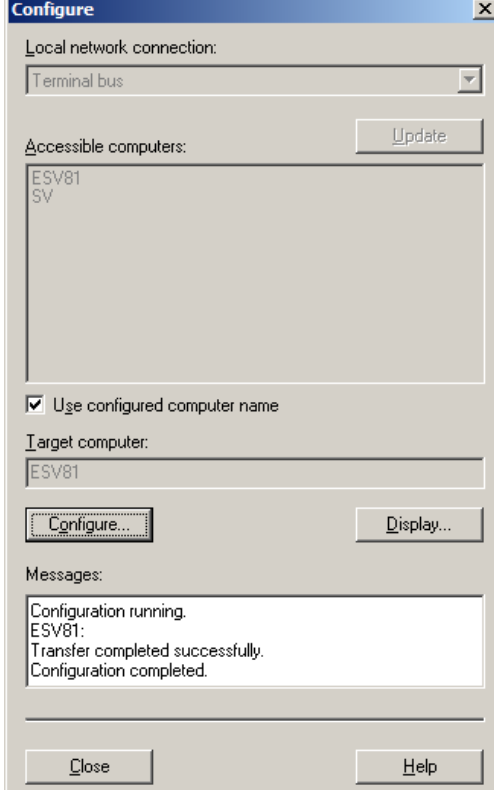
Step	Activity	Screenshot
3.	<p>In the window that appears you will see how the PC station is configured. Click the "OK" button to confirm this setting.</p>	
4.	<p>Confirm the information dialog by clicking on "OK".</p>	
5.	<p>In the bottom window you will then see the message: "Transfer completed successfully". Close the configuration dialog.</p>	



6.3 Step-by-Step configuration



Step	Activity	Screenshot
6.	Configure the Station Configuration Editor of the Standby OS as shown in steps 1 to 5.	

**Configuring and loading AS-OS communication**

In the following section, the connections between the PC stations and the AS are configured in NetPro and loaded in the individual stations.

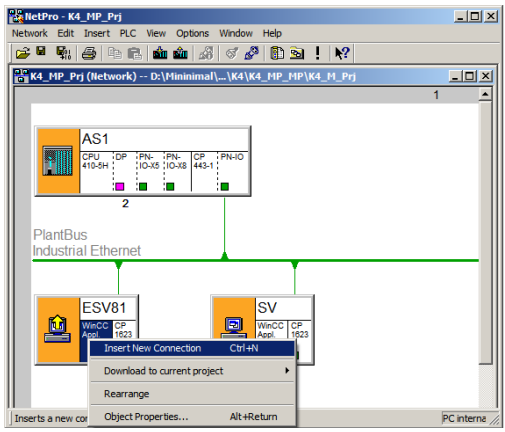
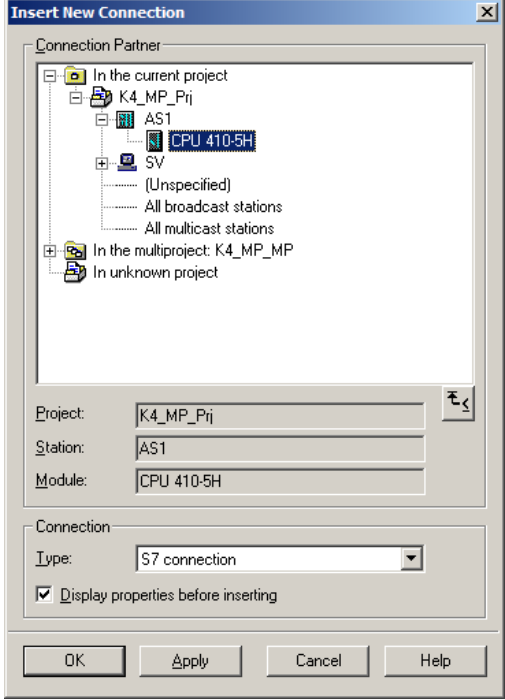
**Note** In case of a granular station configuration, the subnets of the individual sub-projects must be first merged.

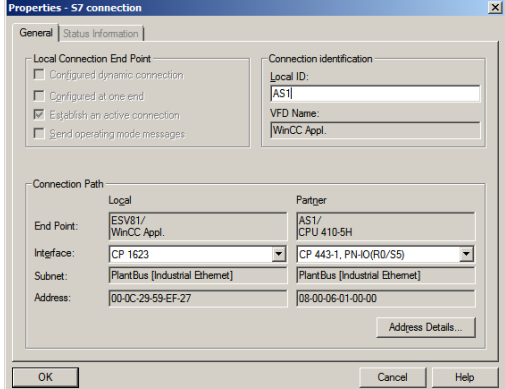
Step	Activity	Screenshot
1.	Open NetPro. Select the WinCC application of the ES and open the shortcut menu. Select "Insert New Connection".	
2.	Select the CPU of the AS in the "Connection Partner" window. Make sure that an "S7 connection" is selected under "Connection".	

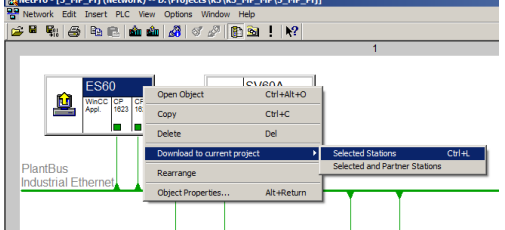
Step	Activity	Screenshot
3.	<p>Under "Connection identification" in the "General" tab, change the "Local ID:" to a descriptive name, such as AS60. Click the "OK" button to confirm the settings.</p>	
4.	<p>Also create a connection between the Standby OS and the AS by repeating steps 1 to 3. When doing this it is important that the connection has the same name as the connection of the ES to the AS. When ready, save and compile the configuration via the menu command: "Network &gt; Save and Compile...".</p> <p>Select the option button "Compile and check everything" and confirm your selection with the "OK" button.</p>	
5.	<p>Select the ES and download the connections via the shortcut menu: "Download to current project &gt; Selected Stations".</p> <p>Download the Standby OS and the AS in the same way. Then close NetPro.</p>	

© Siemens AG 2016 All rights reserved

### Compiling and loading the user program

Compile the S7 program and download it to the AS.

### Compiling the OS project

Compile the OS project of the Standby OS in SIMATIC Manager.

Make sure to make the correct OS assignment to the server in the plant view.

### 6.3.2 OS configuration

#### OS configuration on the engineering station

On the ES, a conversion must be still done from a multi-user to a single-user system, and the settings for the redundancy and time synchronization must be still adjusted.

**Note**

In this particular configuration, it is necessary to complete the redundancy settings in WinCC Explorer of the Standby OS after the entire download completes.

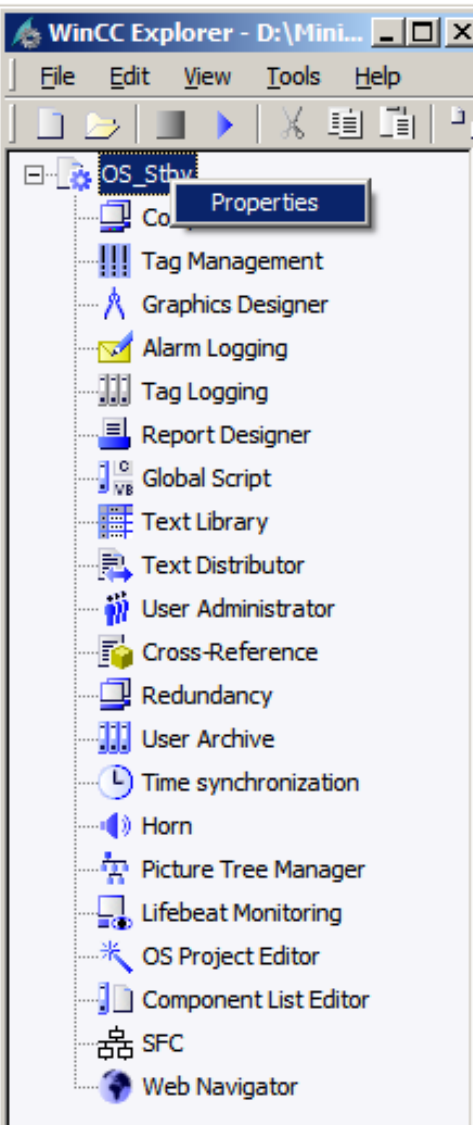
Step	Activity	Screenshot
1.	<p>Open the OS project of the Standby OS in the ES.</p> <p>Select the OS project in the open WinCC Explorer and select "Properties" in the shortcut menu.</p>	 <p>The screenshot shows the WinCC Explorer application window. The title bar reads 'WinCC Explorer - D:\Mini...'. The menu bar includes 'File', 'Edit', 'View', 'Tools', and 'Help'. The toolbar contains icons for file operations. The main workspace displays a tree view of the project structure. The 'OS_Std' project is selected, and a context menu is open over it, with the 'Properties' option highlighted. Other visible options in the tree include 'Co...', 'Tag Management', 'Graphics Designer', 'Alarm Logging', 'Tag Logging', 'Report Designer', 'Global Script', 'Text Library', 'Text Distributor', 'User Administrator', 'Cross-Reference', 'Redundancy', 'User Archive', 'Time synchronization', 'Horn', 'Picture Tree Manager', 'Lifebeat Monitoring', 'OS Project Editor', 'Component List Editor', 'SFC', and 'Web Navigator'. A status bar at the bottom of the window says 'Press F1 for Help.'</p>

6.3 Step-by-Step configuration

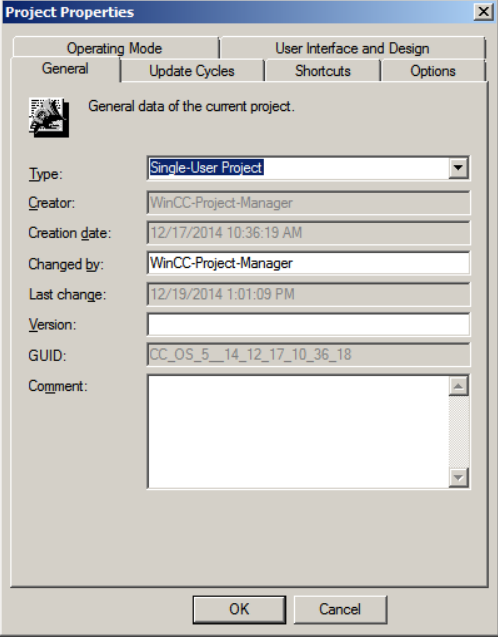
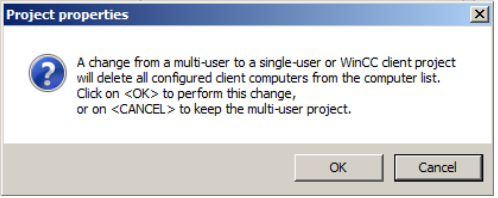
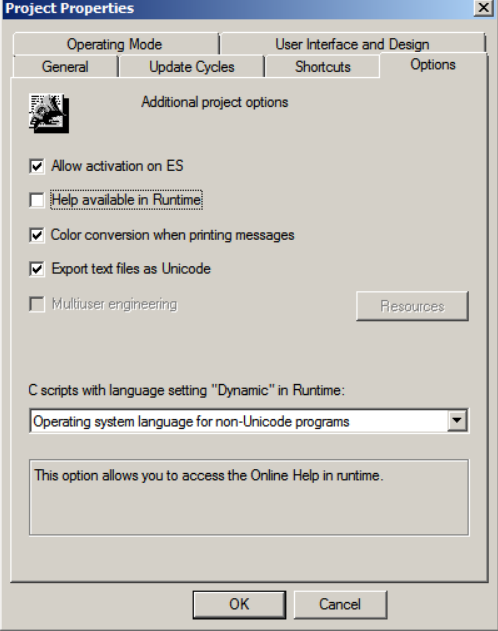
Step	Activity	Screenshot
2.	<p>Under "Type:" in the "General" tab, select the project "Single-User Project" from the drop-drop-down list.</p> <p>Confirm your settings and the displayed message by clicking the "OK" button.</p>	 
3.	<p>Activate the OS project option "Allow activation on ES" from the "Options" tab. This setting allows the runtime to be activated in the ES. Then click on the "OK" button.</p>	

## 6 ES/Master OS and Standby OS

### 6.3 Step-by-Step configuration

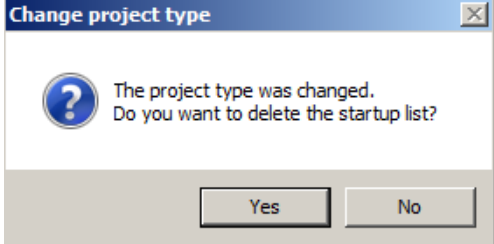
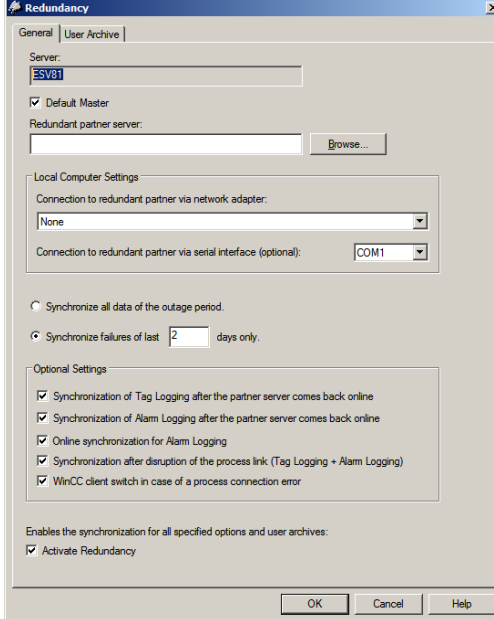
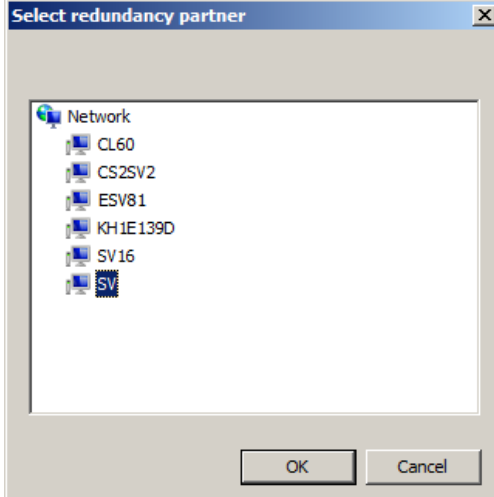
Step	Activity	Screenshot
4.	<p>Prevent deleting the startup list by clicking the "No" button.</p> <p>Confirm the displayed message by clicking on "OK".</p>	
5.	<p>Open the "Redundancy" editor.</p> <p>Activate the "Activate Redundancy" option.</p> <p>Select the option "Default Master".</p> <p>Adjust the redundancy properties in "Optional Settings" according to your requirements.</p> <p>If you do not want to operate the RS 232 redundancy cable on the COM1 interface, you must adjust this setting later yourself on the Standby OS (see section "OS configuration on the Operator Station").</p>	
6.	<p>To complete the redundancy settings for the ES, the partner server must be still selected.</p> <p>Click the "Search ..." button and select the Standby OS as a redundant partner from the network.</p> <p>Click the "OK" button to confirm the settings.</p>	

## 6 ES/Master OS and Standby OS

### 6.3 Step-by-Step configuration

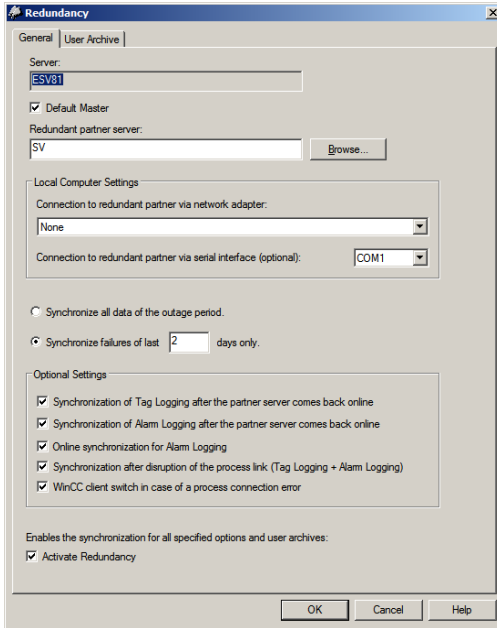
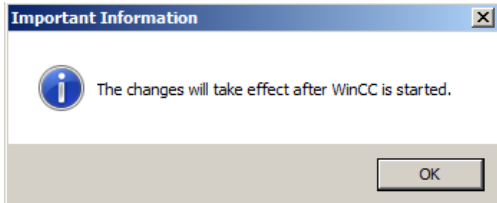
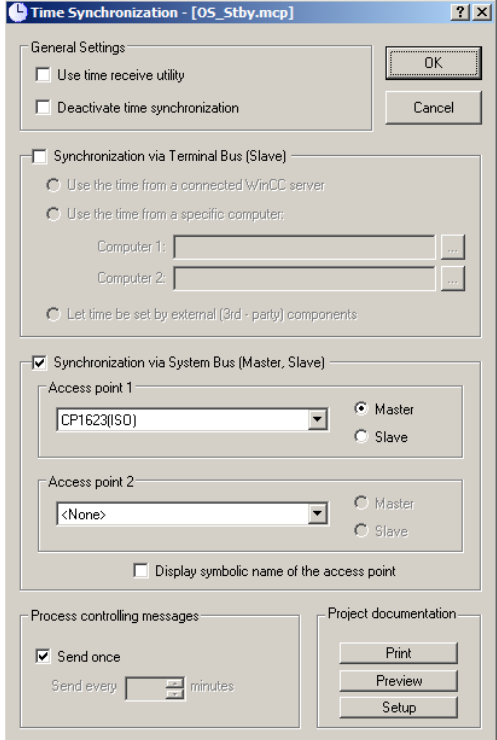
Step	Activity	Screenshot
	<p>Double check all your options before you confirm the redundancy settings with the "OK" button.</p> <p>Confirm the displayed note by clicking the "OK" button.</p>	 
7.	<p>Open the "Time Synchronization" editor. Activate the check box "Synchronization via System Bus (Master, Slave)". Select "CP1623(ISO)" under "Access point 1" and activate the check box "Master". Click the "OK" button to confirm the settings.</p> <p><b>Note</b> If the ES does not have a CP1623, then activate the option "Display symbolic name of the access point" and select the appropriate access point.</p>	
8.	Close the OS project.	

**Downloading the OS project to the Standby OS**

Once the redundancy and time synchronization are configured on the ES and the OS project is closed again, download the OS project on the Standby OS.

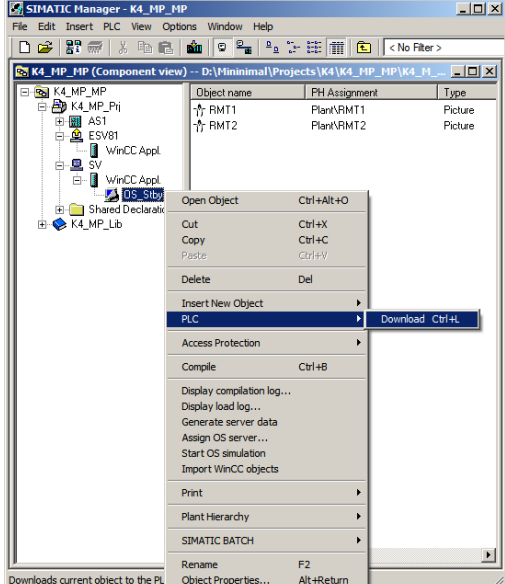
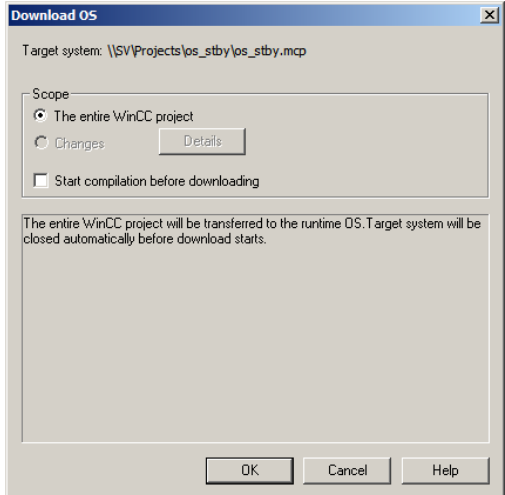
Step	Activity	Screenshot
<p>1.</p>	<p>In SIMATIC Manager, select the Standby OS and choose the following in the context menu: "PLC &gt; Download".</p>	 <p>The screenshot shows the SIMATIC Manager interface with a project tree on the left. The 'OS_Stby' project is selected. A context menu is open over it, with 'PLC' selected and 'Download' highlighted. The background shows a table with columns 'Object name', 'PH Assignment', and 'Type', listing objects like RMT1 and RMT2.</p>
<p>2.</p>	<p>For the first OS project download, an entire download is required. Start the download by clicking the "OK" button.</p>	 <p>The screenshot shows the 'Download OS' dialog box. The 'Target system' is set to '\\SV\Projects\os_stby\os_stby.mcp'. Under 'Scope', 'The entire WinCC project' is selected. There are 'OK', 'Cancel', and 'Help' buttons at the bottom.</p>

## 6 ES/Master OS and Standby OS

### 6.3 Step-by-Step configuration

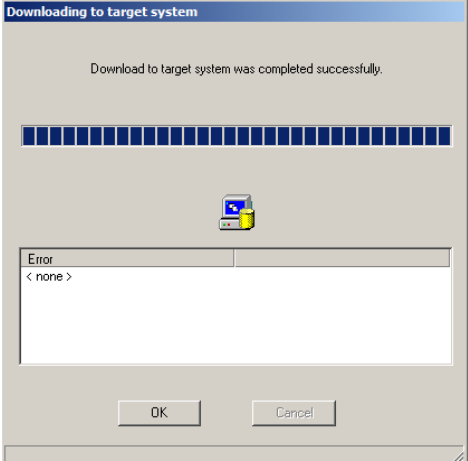
Step	Activity	Screenshot
3.	<p>After a successful download, the OS project is located in the specified folder on the Standby OS.</p> <p>Click the "OK" button to confirm the corresponding message.</p>	



**OS configuration on the Standby OS**

In this particular configuration, it is necessary to complete the redundancy settings after the download completes.

If, as opposed to the operator station, the engineering station has no CP1623 or if the RS 232 redundancy cable is not connected to the COM1 port, the following step instructions must be carried out. Generally we advise you to check the project settings after the project has been downloaded to the target system.

**Note**

Normally, all the engineering work will be carried out on the ES for the purpose of consistent data management, so that no WinCC engineering licenses are required on the OS. Nevertheless, each time the WinCC Explorer is opened, a licence-free time window of two hours is enabled for WinCC configuration works.

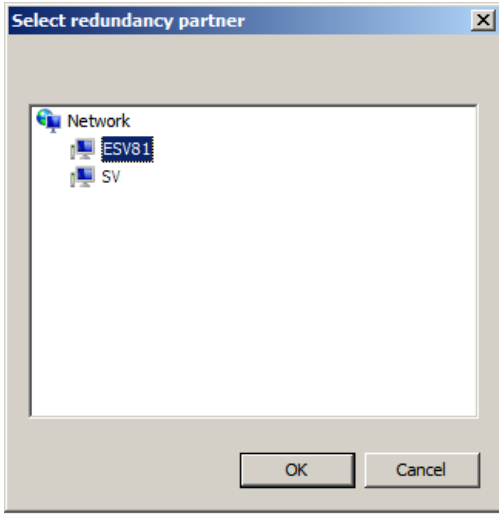
Step	Activity	Screenshot
1.	Open the OS project on the OS standby under the shared project folder.	
2.	Open the "Redundancy" editor from the shortcut menu.  Click the "Search ..." button and select the ES computer as a redundant partner.	

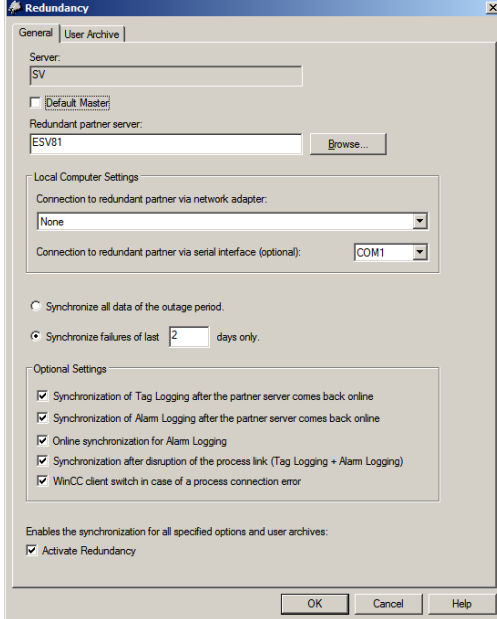
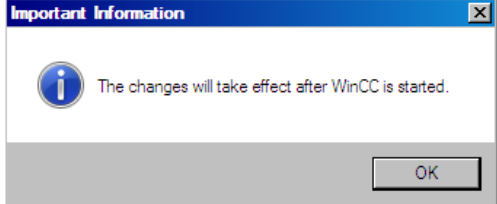
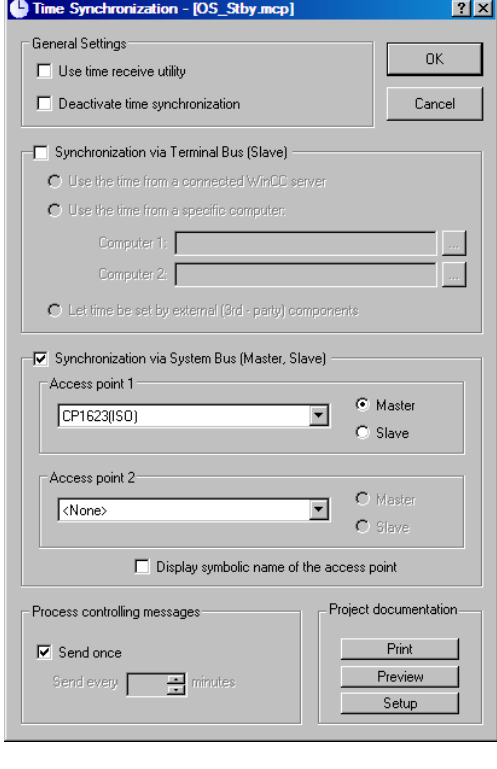
Step	Activity	Screenshot
	<p>Deactivate the check box "Default Master". Check whether your desired check boxes are activated under "Optional Settings".</p> <p>Click the "OK" button to confirm the settings.</p>	
	<p>Confirm the displayed note by clicking the "OK" button.</p>	
<p>3.</p>	<p>Open the editor "Time Synchronization" from the shortcut menu.</p> <p>Check or activate the check box "Synchronization via System Bus (Master, Slave)".</p> <p>Check or select "CP1623(ISO)" and the option button "Master" under "Access point 1".</p> <p>Always click the "OK" button to confirm the settings.</p>	

Step	Activity	Screenshot
4.	If you have carried out project changes in WinCC Explorer, close the OS project and reopen it for the settings to take effect.	

### 6.3.3 Activating the runtime

Activate the OS project, first on the ES and also on the Standby OS. It is recommended to wait before activating the second runtime until the boot process of the first one has completed.

With regard to redundancy, the online synchronization is immediately active. As opposed to this, the mutual synchronization of archives only starts 10 minutes later.

### 6.3.4 Particularities when loading the OS project changes

#### Loading changes

To download changes, the runtime on the ES must be stopped when compiling the OS. These can be then re-activated to test the modified OS functions.

**NOTICE** Depending on the changes performed, if the runtime remains active during OS compilation, it can happen that a subsequent downloading of changes is not performed completely, which will cause errors. If this happens, only an entire download is possible.

For the downloading process, the runtime must be terminated and the OS Project closed.

This results in the operator being restricted from taking any actions on the ES computer.

#### Complete download

For a complete download the following must be always observed:

1. The runtime must be deactivated on both PC stations and the OS project must be closed.
2. Before enabling the runtime on the Standby OS again, the redundancy settings must be set again.

Do this by repeating the steps in the table on page 97.

## 7 Expansion with the PCS 7 OS Web Option

### Positioning

In order to control automated processes via the Internet/Intranet, SIMATIC PCS 7 provides operating and monitoring options: the so-called "Web Options".

This chapter describes the configuration of the Web Option on one ES/OS single-user system. The instructions can also be used as an expansion for the following minimal configurations:

- ES/OS single-user system (Chapter 3)
- ES/Master OS and Standby OS (Chapter 6)

### Note

To expand the redundant single-user system configuration with the Web Option, the ES/OS station in the following example has been configured as a Web Server. The partner OS could also be used the same way as a Web Server. Nothing changes in the functionality for the Web clients.

The redundancy of the operator stations is not available for Web clients. If the OS with the Web Server option is in STOP, even the Web clients have no connection to the process.

### Function

All relevant pictures and scripts are stored on the Web Server to enable them to be displayed or run through a Web client.

The Web client accesses the system data provided by the Web Server via a TCP/IP connection. The user interface corresponds to the appearance of a standard OS client with overview, work and key area.

The following functions are some of the ones available via Web:

- Operator control and monitoring functions, which are also used on an OS client
- Message lists that are called up in a user-dependent manner, just like on an OS client. Messages can be acknowledged in a user-dependent manner.
- Displaying the picture hierarchy according to the plant hierarchy
- Group display function including the "loop-in-alarm" function
- Extended status display

### Note

For further information about the PCS 7 Web Options, see the following manual: ["SIMATIC Process Control System PCS 7 Web Option for OS \(V8.2\)"](#)

## 7.1 Web configurations

In our example, the configuration of the Web Option represents an expansion of the hardware and software configurations mentioned in chapter 3, "ES/OS single-user system" and chapter 6 "ES/Master OS and Standby OS".

### ES/OS single-user system with OS Web Server option

To operate and monitor the system process, the OS Web clients draw their project data from the single-user system with the OS Web Server option via Internet/Intranet by means of Internet Explorer.

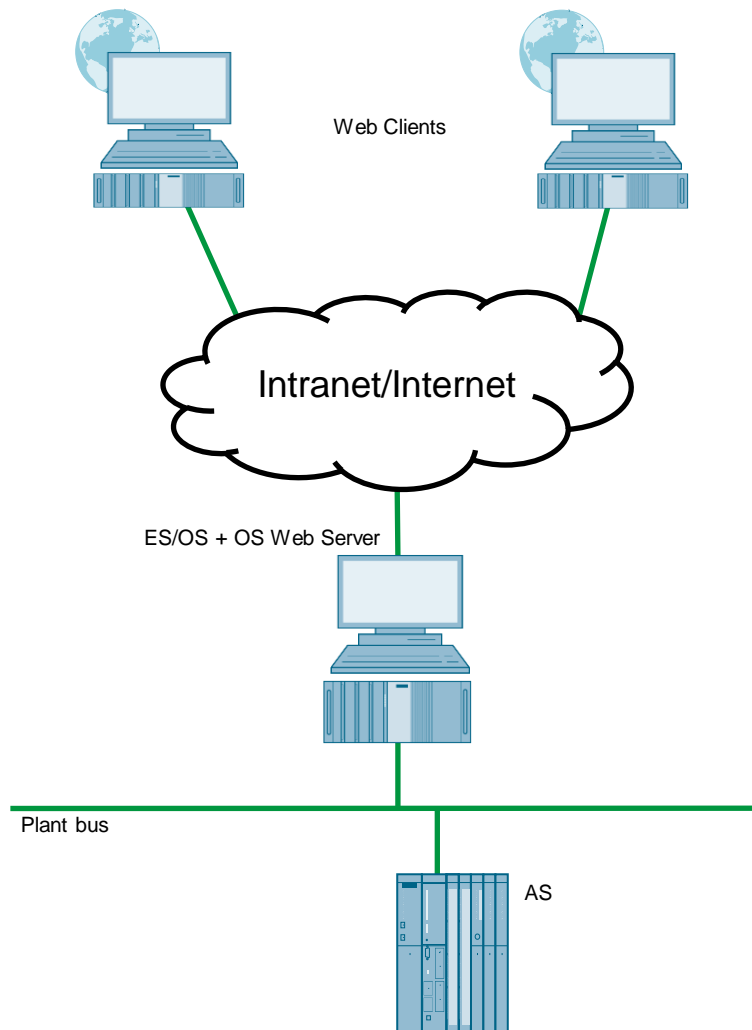

**ES/Master OS with OS Web Server option**

To operate and monitor the system process, the OS Web clients draw their data from the single-user system with the OS Web Server option via Internet/Intranet by means of Internet Explorer.

In addition, the system process is set as redundant to offer a widest possible protection against failure of system operation.

**NOTICE**

The redundancy of the operator stations is not available for Web clients. If the OS with the Web Server option is in STOP, the Web clients have no process connection.

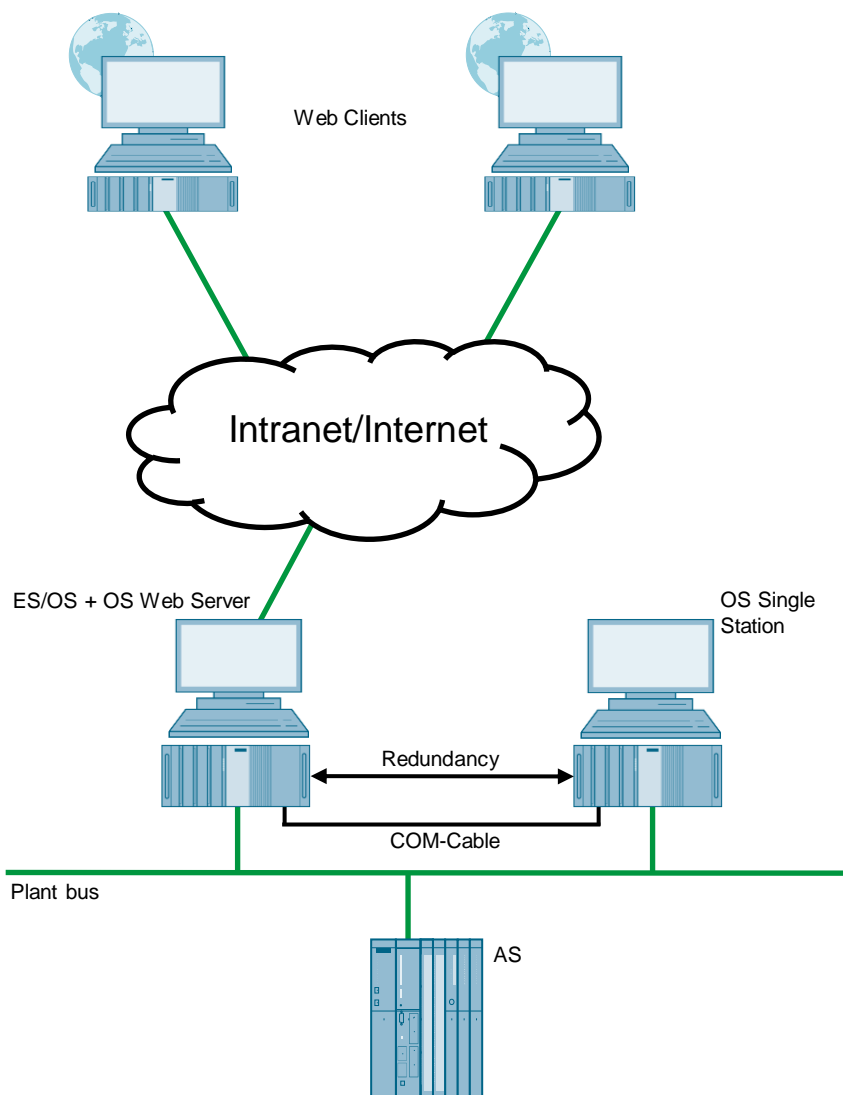

## 7.2 Web-specific hardware and software requirements

### Single-user system with Web Server option

Characteristic	Requirement
Operating system	<ul style="list-style-type: none"> <li>Windows 7 Ultimate/Enterprise SP1 (32 bit)</li> <li>Windows Server 2008 R2 SP1 Standard Edition (64 bit)</li> </ul> <p>For further information, see the document <a href="#">"SIMATIC Process Control System PCS 7 Readme V8.2 (online)"</a>.</p>
Hardware	<ul style="list-style-type: none"> <li>SIMATIC PCS 7 ES/OS IPC847D BCE</li> <li>SIMATIC PCS 7 ES/OS IPC847D IE</li> </ul> <p>For further information, see the document <a href="#">"SIMATIC Process Control System PCS 7 Readme V8.2 (online)"</a>.</p>
Software	<ul style="list-style-type: none"> <li>Internet Explorer</li> <li>Internet Information Server (IIS)</li> </ul>
Other	Faster access ( $\geq 64$ kbit/s) to the Web client via internet/intranet or TCP/IP connection

**Web client**

Characteristic	Requirement
Operating systems	<ul style="list-style-type: none"> <li>Windows 7 Ultimate/Enterprise SP1 (32 bit)</li> <li>Windows 7 Ultimate/Enterprise SP1 (64 bit)</li> <li>Windows Server 2008 R2 SP1 Standard Edition (64 bit)</li> </ul> <p>For further information, see the document "<a href="#">SIMATIC Process Control System PCS 7 Readme V8.2 (online)</a>".</p>
Minimum hardware requirements	No PDAs, tablet PCs etc.
Software	Internet Explorer
Other	Faster access ( $\geq$ 64 kbit/s) to the Web client via internet/intranet or TCP/IP connection

**Note**

The Internet Explorer version must be selected according to the PCS 7 version. For further information, see the following FAQ:  
<https://support.industry.siemens.com/cs/ww/en/view/2334224>

## 7.3 Maximum amount of Web client connections

The following number of concurrent Web client connections have been tested and thus released:

Operating system on the stand-alone system with Web Server option	Maximum number of concurrent Web connections
Windows 7	3
Windows Server 2008	3



## 7.4 Configuring the OS Web Server

### Configuration steps on the ES

- Publishing pictures via Web View Publisher
- Configuring user rights, start screen and language of the website in the User Administrator
- Downloading and compiling the Web Server

### Publishing OS data

The Web Publisher enables pictures and scripts, which should later run on the Web clients, to be published on the OS Web Server. The following actions are performed:

- Project data is compressed and saved
- Picture windows are converted into Internet-enabled ActiveX components
- Scripts are converted so that they run on the Web

### Requirements

Before publishing the Web Server data, the following requirements must be met:

- The hardware and software requirements mentioned in chapter 7.2 have been met.
- The software package "PCS 7 Web Server" is installed on the ES/OS single-user system.
- The PCS 7 Project is available and fully configured.
- "OS compiling" has been completed.
- The scripts that are accessed by the Web clients are present.
- Process pictures contain no double underscore (e.g. yy\_\_xx.pdl).
- Tag names in plain text (quotation marks) within C scripts contain no spaces.

### Note

In a single-user system, only one publishing process is needed for the publishing of local data on the Web Server.

For information regarding the subject "supported script standard functions" see the chapter "Web-enabled Functions for PCS 7 OS Web Option" in the manual: "[SIMATIC PCS 7 Web Option for OS \(V8.2\)](#)".

7.4.1 Publishing project data

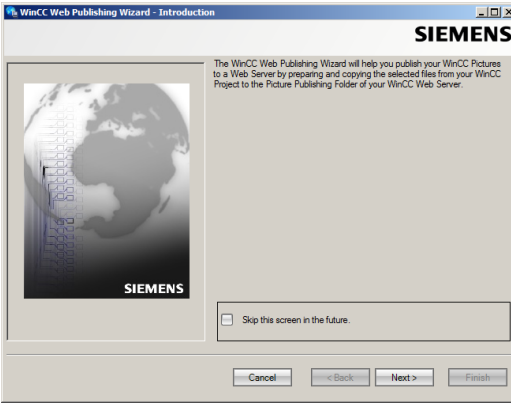
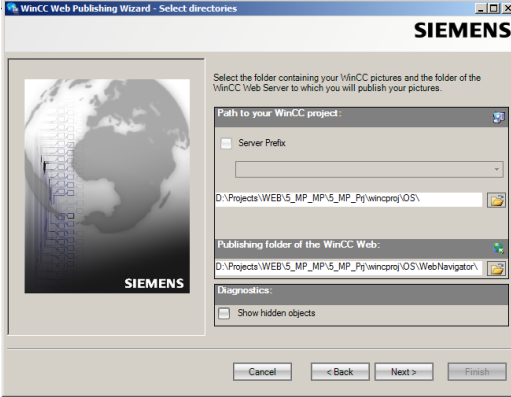
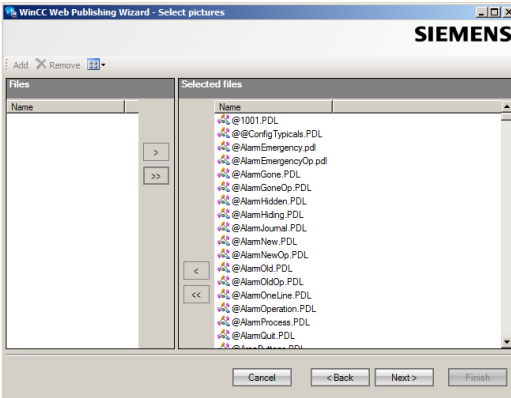
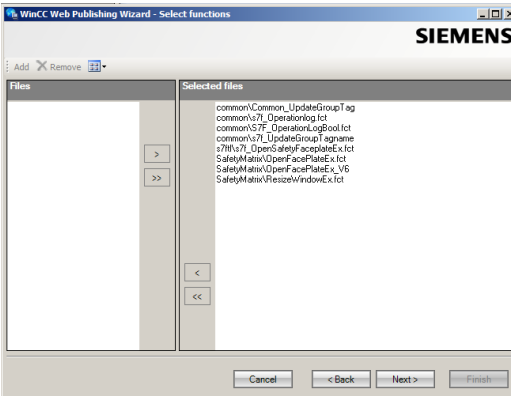
Step	Action	Remark
1.	<p>Open the OS project of the OS Web Server in WinCC Explorer.</p> <p>Using the shortcut menu of the "Web Navigator" editor, select the command "Web View Publisher".</p> <p>The dialog box "WinCC Web Publishing Wizard - Introduction" opens.</p> <p>Click on the "Next" button.</p>	
2.	<p>This opens the dialog box "WinCC Web Publishing Wizard – Select files and folders".</p> <p>Deactivate the check box "Server Prefix" because you want to publish local data.</p> <p>Accept the default destination and source path. If you really want to change the respective path, click on the button behind the grayed entry fields. Navigate to the desired target or source folder.</p> <p>Click on the "Next" button.</p>	
3.	<p>The dialog box "WinCC Web Publishing Wizard - Select pictures" opens.</p> <p>Select all pictures you wish to publish. We recommend to publish all standard pictures.</p> <p>Use the "&gt;&gt;", "&lt;&lt;", "&gt;" and "&lt;" buttons to select the pictures.</p> <p>Click on the "Next" button.</p>	
4.	<p>The dialog box "WinCC Web Publishing Wizard - Select functions" opens.</p> <p>Select all functions you wish to publish. In the pictures, only the scripts that you selected during the publication process are available. Therefore, select all the needed functions at every publication process.</p> <p>Use the "&gt;&gt;", "&lt;&lt;", "&gt;" and "&lt;" buttons to select the functions.</p> <p>Click on the "Next" button.</p>	

## 7 Expansion with the PCS 7 OS Web Option

### 7.4 Configuring the OS Web Server

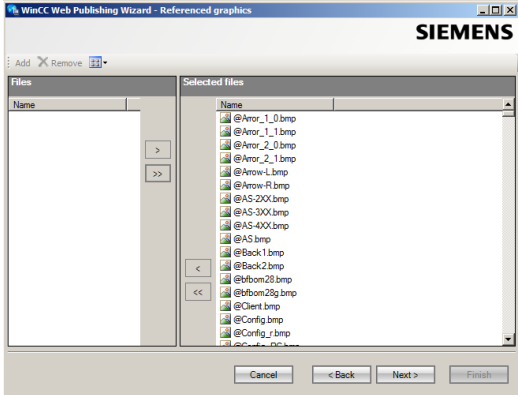
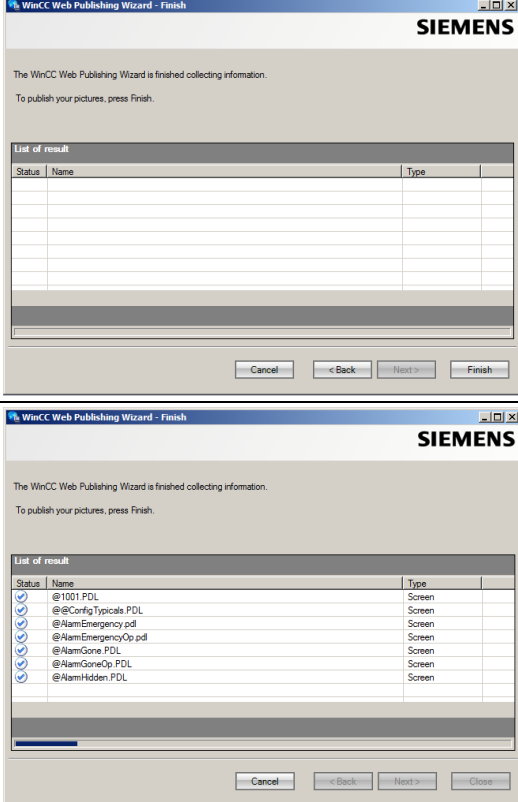
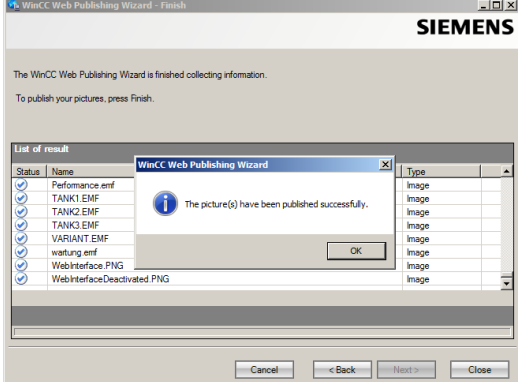
Step	Action	Remark
5.	<p>The dialog box "WinCC Web Publishing Wizard - Referenced graphics" opens.</p> <p>Select all the graphics you wish to publish. We recommend to publish all standard graphics.</p> <p>Use the "&gt;&gt;", "&lt;&lt;", "&gt;" and "&lt;" buttons to select the graphics.</p> <p>Click on the "Next" button.</p>	
6.	<p>The dialog box "WinCC Web Publishing Wizard - Finish" opens.</p> <p>Click "Finish".</p>	
7.	<p>Pictures and functions that contain faulty scripts are identified from a red cross.</p> <p>Double-click on each faulty picture to open the picture in the editor "PdIPad" and to correct it.</p> <p>Once the publishing process is complete, click the "OK" button to confirm the message.</p>	



### 7.4.2 Setting up user rights, website start screen and language

#### Restriction of access

You can control the connections of the Web client to the OS Web Server by defining user rights. User rights are assigned in the editor "User Administrator". User rights are the same as those of the standard clients.

#### Settings in the editor "User Administrator"

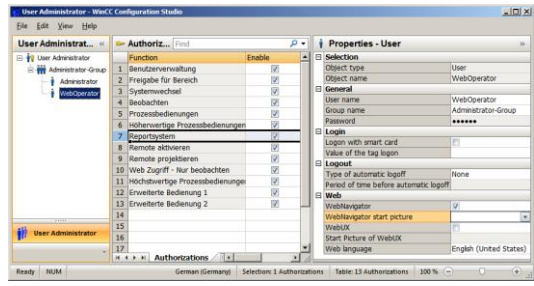
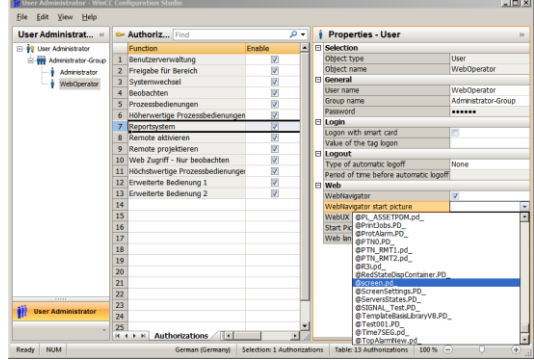
Step	Action	Remark
1.	<p>Open the editor "User Administrator" in the WinCC Explorer of the currently open OS project.</p> <p>Add the new users and/or new user groups to which you want to assign appropriate permissions.</p> <p>Also activate the option button "Web Navigator" for the user/s or user group/s and enter the website in the corresponding input fields "Start Screen" and "Language".</p>	
2.	<p>Use the "..." button to select the start screen from the published graphics.</p> <p>"... \OS Web Server\&lt;wincc-projectrelease-Name&gt;\Web Navigator\pictures"</p> <p>Select the graphic "@screen.pd_" as start screen.</p> <p>Click the "OK" button to confirm your selection.</p> <p>You can also specify a language for the control and monitoring interface of the Web clients. To do this, you must also click the corresponding button "...".</p> <p>Click the "OK" button to confirm your selection.</p>	
3.	Close the User Administration Editor.	

### 7.4.3 Configuring with the Web Configurator

#### Web Configurator tasks

The Web Configurator enables you to configure and manage the Internet Information Service (IIS) and therefore the website of the OS Web Server. The setting up is performed on the Web Server after you have downloaded the project to the Web Server. Setup and configuration are necessary to set up an operating station (OS) as an OS Web Server and to make it accessible for the Web clients via the intranet/internet.

The Web Configurator enables you to adjust the necessary firewall settings, if a firewall is enabled.

#### Requirements of the single-user system

- The PCS 7 Web Server software is installed on the single-user system
- The OS project has been downloaded to the single-user system
- All settings have been entered in the OS
- Pictures, functions and graphics are published
- User rights have been granted/applied

#### Note

For further information about the default Web page, see the chapter "Configuration on the OS Web Server" in the manual: "[SIMATIC PCS 7 Web Option for OS \(V8.2\)](#)".

**Settings in the editor "Web Navigator"**

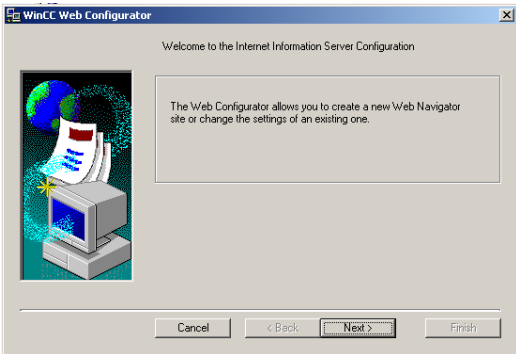
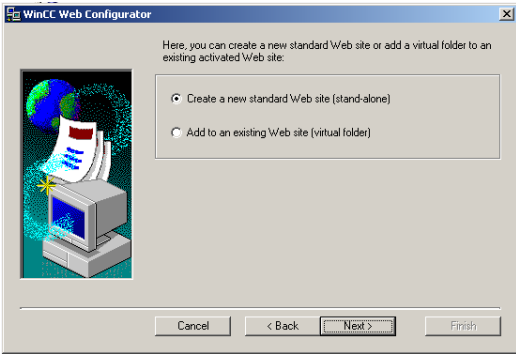
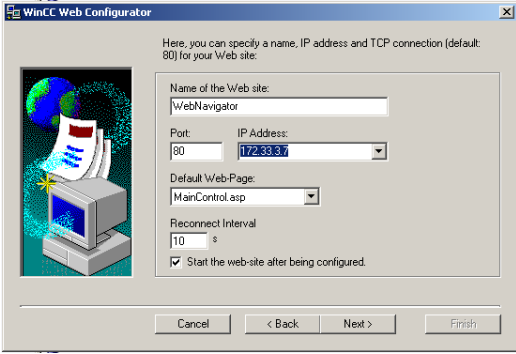
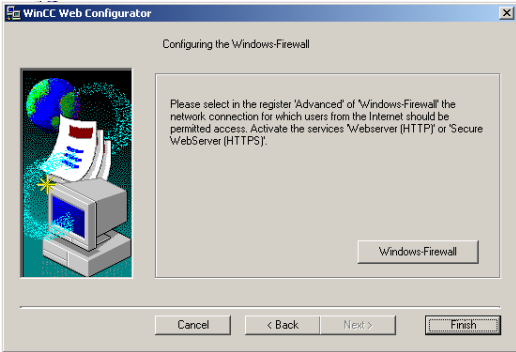
Step	Action	Remark
1.	<p>Open the OS project in WinCC Explorer on the OS Web Server.</p> <p>Using the shortcut menu of the "Web Navigator" editor, select the command "Web Configurator".</p> <p>The dialog box "WinCC Web Configurator" opens.</p> <p>Click on the "Next" button.</p>	
2.	<p>In the next window, select "Create a new standard Web site (stand-alone)".</p> <p>Click on the "Next" button.</p>	
3.	<p>Assign a name to your website in the "Name of the Web site" text box.</p> <p>Also assign the IP address and connection port of the computer using the text boxes "Port" and "IP address".</p> <p>In the "Default Web-Page" text box, select "MainControl" from the drop-down list.</p> <p>Also enter a time interval in the text box "Reconnect Interval".</p> <p>Activate the check box "Start the web-site after being configured".</p> <p>Click on the "Next" button.</p> <p>If your Windows firewall is not activated, skip to step "7".</p>	
4.	<p>Click on the "Windows Firewall" button (the button is only visible if the firewall is activated).</p>	

## 7 Expansion with the PCS 7 OS Web Option

### 7.4 Configuring the OS Web Server

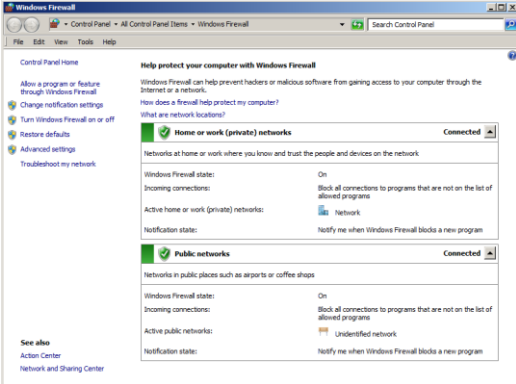
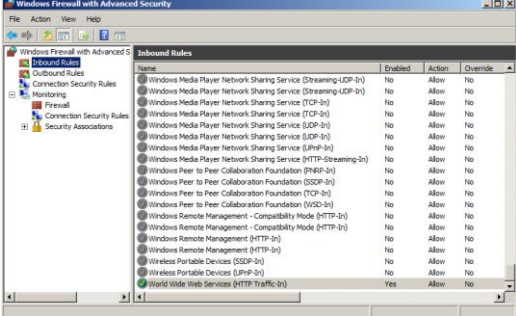
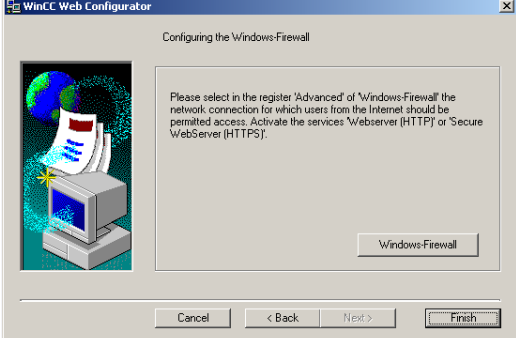
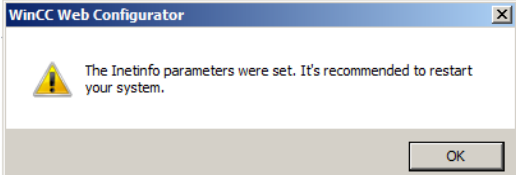
Step	Action	Remark
5.	Click the button "Advanced Settings" in the "Windows Firewall" dialog box.	
6.	Check whether the inbound rule "World Wide Web Services (HTTP Traffic-In)" is activated. If this feature is deactivated, select it and choose the command "Enable" in the shortcut menu.	
7.	Click "Finish".	
8.	Click the "OK" button. Then close WinCC Explorer and restart your computer to apply the settings.	



#### 7.4.4 Downloading and compiling the Web Server

##### Downloading the Web Server

Since the OS Web Server function is on a single-user system (ES/OS/Web Server), it is not necessary to perform a download or changes download of project data. Thanks to the "Compile OS", the necessary data are already available locally.

##### Compiling

The "Compile Changes" function can be performed in single-user systems without having to interrupt the process mode of the Web Server.

##### Note

For further information about the default Web page, see the chapter "Configuring the OS Web Server on an ES" in the manual: "[SIMATIC PCS 7 Web Option for OS \(V8.2\)](#)".

## 7.5 Settings for the Web client

### Settings for the Web content zone "Internet" or "Local Intranet"

In Internet Explorer, you must adjust/check the settings for the Web content zone, so that later you'll be able to install the plug-ins for the Web client from the OS Web server.

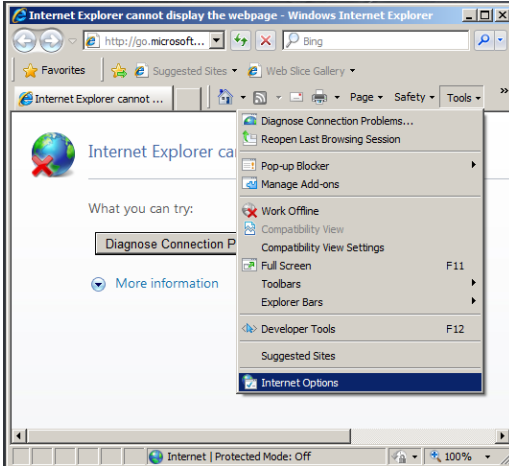
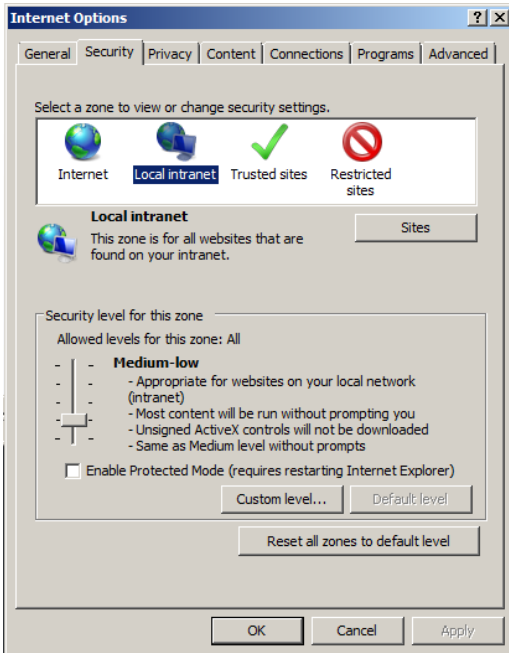
Step	Action	Remark
1.	Open Internet Explorer. Select the menu command: "Tools > Internet Options".	
2.	Click on the "Security" tab. Select the Web content zone in which the Web server resides ("Internet" or "Local intranet"). Click on the "Custom Level" button.	

7 Expansion with the PCS 7 OS Web Option

7.5 Settings for the Web client

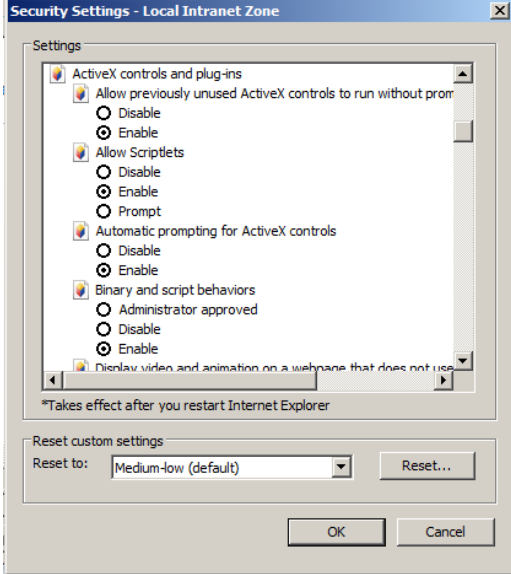
Step	Action	Remark
3.	Activate the option buttons under "Run ActiveX controls that are safe for scripting" and "Download signed ActiveX controls".	
4.	Click on each of the "OK" button for the dialog boxes "Security Settings" and "Internet Options" to close them.	

**Settings for the Web content zone "Trusted sites"**

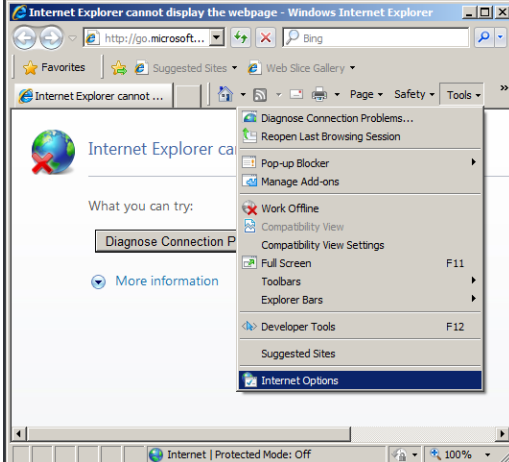
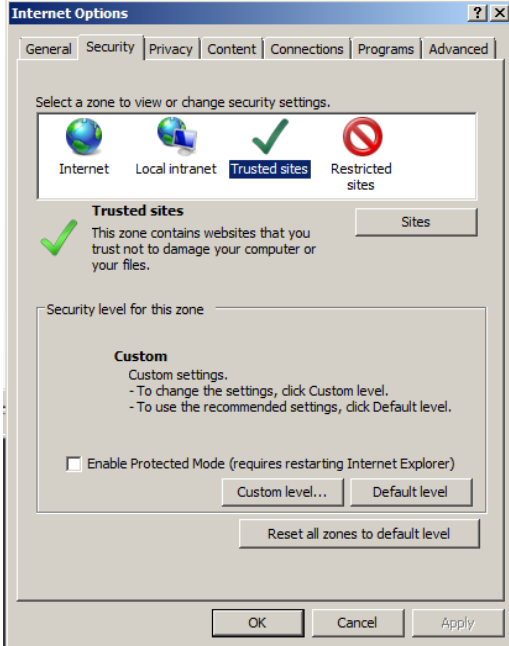
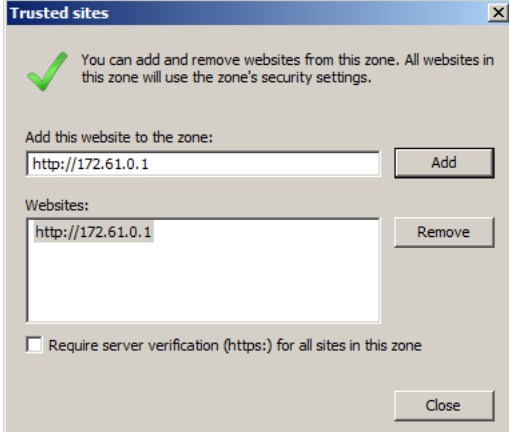
Step	Action	Remark
1.	<p>Open Internet Explorer.                      Select the menu command: "Tools &gt; Internet Options"</p>	
2.	<p>Click on the "Security" tab.                      Select the Web content zone "Trusted sites".                      Click the "Sites" button to open the dialog box.</p>	
3.	<p>In the text box "Add this website to the zone", insert the address of the OS Web server (7.4.3 Configuring with the Web Configurator &gt; Settings in the editor "Web Navigator")                      e.g. *://172.61.0.1 or <a href="http://*.microsoft.com">http://*.microsoft.com</a>                      Also deactivate the check box "Require server verification (https:)" for all sites in this zone".                      Click on the "Add" and "Close" buttons.</p>	

7 Expansion with the PCS 7 OS Web Option

7.5 Settings for the Web client

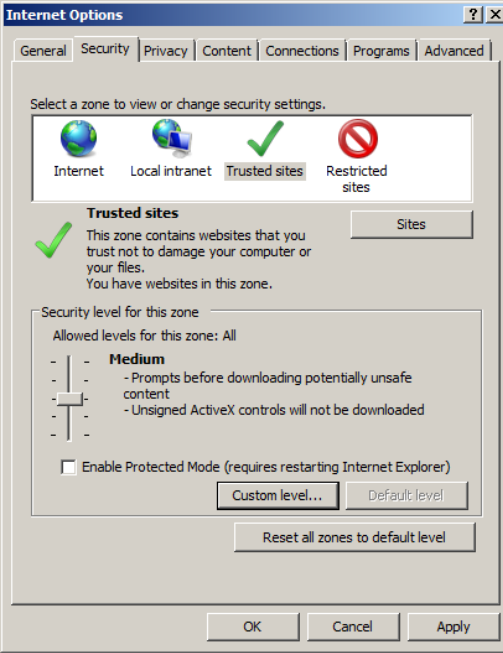
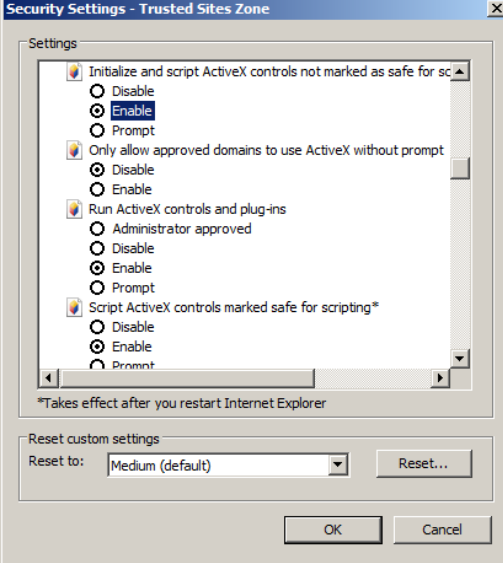
Step	Action	Remark
4.	<p>Select the Web content zone "Trusted sites".</p> <p>Click on the "Default level" button and then on the "Custom level" button.</p>	
5.	<p>In the "Security Settings" dialog box, enable the option button under "Initialize and script ActiveX controls not marked as safe for scripting".</p>	
6.	<p>Click on each of the "OK" button for the dialog boxes "Security Settings" and "Internet Options" to close them.</p>	

You have now managed to create the conditions required for a connection from of a Web client to a Web server.

## 7.6 Installing the Web client plug-ins

### Installation ways

During the installation of plug-ins for Internet Explorer, you can choose between two installation ways:

- Remote Installation - Installation via the Intranet/Internet from the Web server
- Local Installation - Installation via the Windows installer package of the Web client

In this application example, we consider the "remote installation".

### Requirements

- The OS Web server is in runtime.
- The software package "PCS 7 Web Client" is installed on the PC.
- The Web client has access to the Web server.
- You know the Web server's address.
- You know the domain name, username and password.
- The user permissions apply for the PCS 7 Web Options.
- The logon session on the PC has the rights of a primary user.

### Installation

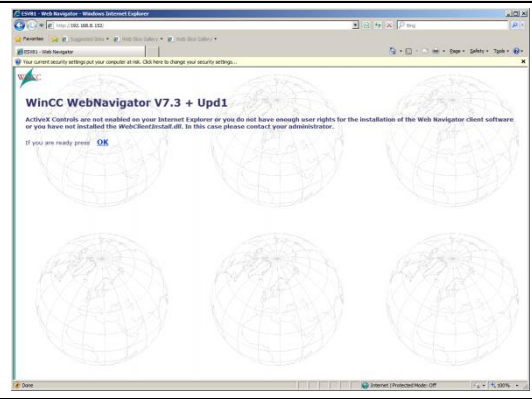
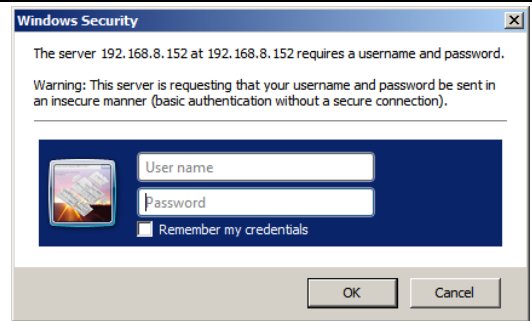
Step	Action	Remark
1.	Open Internet Explorer. Enter the web server address (http://<server name or IP>) in the "Address" text box.	
2.	In the "Enter Network Password" dialog box, enter the credentials that were set in the "User Administrator" editor on the Web server.	

## 7 Expansion with the PCS 7 OS Web Option

### 7.6 Installing the Web client plug-ins

Step	Action	Remark
3.	When you first connect, the "Security Warning" dialog box will open. Proceed by clicking on the "Install" button.	
4.	All the available plug-ins for the Web client will now be displayed in the Internet Explorer window. To install the plug-in, click on the arrow in front of the version number in the "Install" column. The following plug-ins are installed to ensure a minimum of process control: <ul style="list-style-type: none"> <li>WinCC Basic Process Control</li> <li>WinCC Advanced Process Control</li> <li>PCS 7 Basic Faceplates</li> <li>PCS 7 Advanced Faceplates</li> </ul> During installation, always follow the shown sequence.	
5.	The installation of the Web client is complete. Close Internet Explorer and reopen it in order to register for the process control. The process pictures can be called up once the Web client has established a connection to the Web server.	

#### Note

Further information about the topics "Installing a Web client", "Process control on the Web client" and "Settings" in the manual: ["SIMATIC PCS 7 Web Option for OS \(V8.2\)"](#) by reading the chapter: "Installations and Settings for the Web Client"

## 8 History

Version	Date	Change
V1.0	10/2006	First edition V6.1 SP1
V1.1	11/2006	Revised V6.1 SP1
V1.2	05/2009	Revised V6.1 SP1
V2.1	09/2008	First edition V7.0 SP1
V2.2	12/2008	Correction of table 6–2
V2.3	05/2009	Revision V7.0 SP1
V3.0	05/2009	First edition V7.1
V3.1	05/2009	Revision V7.1
V3.2	11/2009	Extension of the document for V7.1 to include the PCS 7 Web Option (tested for PCS 7 V7.1 and V7.0 SP2)
V2.4	12/2010	Note added: The configuration described in chapter 6, "ES/Master OS and Standby OS" only works in PCS 7 V7.0 SP3 if it has WinCC V6.2 SP3 HF8 or higher.
V3.3	09/2011	Note added: The configuration described in chapter 6, "ES/ Master OS and Standby OS" only works in PCS 7 V7.1 SP2 and SP3 if it has WinCC V7.0 SP2 HF5 or higher.
V4.0	10/2012	First edition PCS 7 V8.0 Upd1
V4.1	11/2012	Adaptations in the following chapters: <ul style="list-style-type: none"> <li>Chapter 7 "Expansion with the PCS 7 OS Web Option"</li> <li>Chapter 7.1 "Web configurations"</li> <li>Chapter 7.2 "Web-specific hardware and software requirements"</li> </ul> New chapter: <ul style="list-style-type: none"> <li>Chapter 7.3 "Maximum amount of Web client connections"</li> </ul>
V4.2	01/2013	Introduction in chapter 6 "ES/Master OS and Standby OS" has been editorially revised.
V4.3	05/2013	Test and declaration for PCS 7 V8.0 SP1
V4.4	09/2013	License adjustments in chapter 7.1. "Web configurations" in Figure 7–1 "Web Option in single-user system"
V5.0	02/2015	Test and declaration for PCS 7 V8.1
V6.0	06/2016	Test and declaration for PCS 7 V8.2