

# SIEMENS

## SIMATIC NET

### Industrial Ethernet switches SCALANCE XB-000

#### Operating Instructions

<u>Introduction</u>	<b>1</b>
<u>Safety notices</u>	<b>2</b>
<u>Network topologies</u>	<b>3</b>
<u>Description of the device</u>	<b>4</b>
<u>Assembly and disassembly</u>	<b>5</b>
<u>Connecting up</u>	<b>6</b>
<u>Maintenance and troubleshooting</u>	<b>7</b>
<u>Technical specifications</u>	<b>8</b>
<u>Dimension drawings</u>	<b>9</b>
<u>Approvals</u>	<b>10</b>

## Legal information

### Warning notice system

This manual contains notices you have to observe in order to ensure your personal safety, as well as to prevent damage to property. The notices referring to your personal safety are highlighted in the manual by a safety alert symbol, notices referring only to property damage have no safety alert symbol. These notices shown below are graded according to the degree of danger.

 <b>DANGER</b>
indicates that death or severe personal injury <b>will</b> result if proper precautions are not taken.

 <b>WARNING</b>
indicates that death or severe personal injury <b>may</b> result if proper precautions are not taken.

 <b>CAUTION</b>
indicates that minor personal injury can result if proper precautions are not taken.

<b>NOTICE</b>
indicates that property damage can result if proper precautions are not taken.

If more than one degree of danger is present, the warning notice representing the highest degree of danger will be used. A notice warning of injury to persons with a safety alert symbol may also include a warning relating to property damage.

### Qualified Personnel

The product/system described in this documentation may be operated only by **personnel qualified** for the specific task in accordance with the relevant documentation, in particular its warning notices and safety instructions. Qualified personnel are those who, based on their training and experience, are capable of identifying risks and avoiding potential hazards when working with these products/systems.

### Proper use of Siemens products

Note the following:

 <b>WARNING</b>
Siemens products may only be used for the applications described in the catalog and in the relevant technical documentation. If products and components from other manufacturers are used, these must be recommended or approved by Siemens. Proper transport, storage, installation, assembly, commissioning, operation and maintenance are required to ensure that the products operate safely and without any problems. The permissible ambient conditions must be complied with. The information in the relevant documentation must be observed.

### Trademarks

All names identified by ® are registered trademarks of Siemens AG. The remaining trademarks in this publication may be trademarks whose use by third parties for their own purposes could violate the rights of the owner.

### Disclaimer of Liability

We have reviewed the contents of this publication to ensure consistency with the hardware and software described. Since variance cannot be precluded entirely, we cannot guarantee full consistency. However, the information in this publication is reviewed regularly and any necessary corrections are included in subsequent editions.

# Table of contents

<b>1</b>	<b>Introduction .....</b>	<b>5</b>
1.1	On the Operating Instructions .....	5
<b>2</b>	<b>Safety notices .....</b>	<b>9</b>
<b>3</b>	<b>Network topologies .....</b>	<b>11</b>
<b>4</b>	<b>Description of the device .....</b>	<b>13</b>
4.1	Purpose .....	13
4.2	Product overview .....	14
4.3	Product properties and device views .....	17
4.3.1	SCALANCE XB004-1 .....	17
4.3.2	SCALANCE XB004-2 .....	18
4.3.3	SCALANCE XB004-1LD .....	19
4.3.4	SCALANCE XB004-2LD .....	20
4.3.5	SCALANCE XB005 .....	21
4.3.6	SCALANCE XB008 .....	22
4.3.7	SCALANCE XB004-1G .....	23
4.3.8	SCALANCE XB004-1LDG .....	24
4.3.9	SCALANCE XB005G .....	25
4.3.10	SCALANCE XB008G .....	26
4.4	TP ports (twisted pair) .....	26
4.4.1	Pin assignment .....	27
4.4.2	Functions .....	27
4.4.3	Insulation between the TP ports .....	28
4.5	FO port (fiber optic) .....	30
4.5.1	SCALANCE XB004-1 .....	30
4.5.2	SCALANCE XB004-2 .....	31
4.5.3	SCALANCE XB004-1LD .....	32
4.5.4	SCALANCE XB004-2LD .....	32
4.5.5	SCALANCE XB004-1G .....	33
4.5.6	SCALANCE XB004-1LDG .....	34
4.6	LEDs .....	35
<b>5</b>	<b>Assembly and disassembly .....</b>	<b>37</b>
5.1	Safety notices for installation .....	37
5.2	Types of installation .....	40
5.3	Fixing onto standard mounting rails .....	41
5.4	Wall mounting .....	42
5.5	Disassembly .....	44

<b>6</b>	<b>Connecting up .....</b>	<b>45</b>
6.1	Safety when connecting up.....	45
6.2	Wiring rules .....	48
6.3	Power supply .....	49
6.3.1	Power supply 24 VAC .....	49
6.3.2	Power supply 24 VDC .....	50
6.4	Grounding .....	51
6.5	Twisted pair cable .....	52
6.6	IE FC RJ-45 Plug 180.....	52
<b>7</b>	<b>Maintenance and troubleshooting .....</b>	<b>55</b>
<b>8</b>	<b>Technical specifications .....</b>	<b>57</b>
8.1	SCALANCE XB004-1 .....	57
8.2	SCALANCE XB004-2 .....	59
8.3	SCALANCE XB004-1LD .....	61
8.4	SCALANCE XB004-2LD .....	64
8.5	SCALANCE XB005 .....	66
8.6	SCALANCE XB008 .....	68
8.7	SCALANCE XB004-1G.....	72
8.8	SCALANCE XB004-1LDG.....	76
8.9	SCALANCE XB005G.....	80
8.10	SCALANCE XB008G.....	84
8.11	Mechanical stability (in operation) XB-000 .....	88
<b>9</b>	<b>Dimension drawings.....</b>	<b>89</b>
<b>10</b>	<b>Approvals.....</b>	<b>91</b>
	<b>Index.....</b>	<b>99</b>

# Introduction

## 1.1 On the Operating Instructions

### Purpose of the Operating Instructions

These Operating Instructions support you when commissioning networks with the Industrial Ethernet switches of the SCALANCE XB-000 product line.

### Validity of the Operating Instructions

These operating instructions are valid for the following devices:

Device	Article number
XB004-1	6GK5 004-1BD00-1AB2
XB004-2	6GK5 004-2BD00-1AB2
XB004-1LD	6GK5 004-1BF00-1AB2
XB004-2LD	6GK5 004-2BF00-1AB2
XB005	6GK5 005-0BA00-1AB2
XB008	6GK5 008-0BA00-1AB2
	6GK5 008-0BA10-1AB2
XB004-1G	6GK5 004-1GL00-1AB2
	6GK5 004-1GL10-1AB2
XB004-1LDG	6GK5 004-1GM00-1AB2
	6GK5 004-1GM10-1AB2
XB005G	6GK5 005-0GA00-1AB2
	6GK5 005-0GA10-1AB2
XB008G	6GK5 008-0GA00-1AB2
	6GK5 008-0GA10-1AB2

### See also

SIMATIC NET Industrial TP and Fiber Optic Networks (<https://support.automation.siemens.com/WW/view/en/1172207>)

<https://siemens.com/scalance> (<https://siemens.com/scalance>)

### Further documentation

In the system manuals "Industrial Ethernet / PROFINET Industrial Ethernet" and "Industrial Ethernet / PROFINET passive network components", you will find information on other SIMATIC NET products that you can operate along with the devices of this product line in an Industrial Ethernet network.

There, you will find among other things optical performance data of the communications partner that you require for the installation.

You will find the system manuals here:

- On the data medium that ships with some products:
  - Product CD / product DVD
  - SIMATIC NET Manual Collection
- On the Internet pages of Siemens Industry Online Support:
  - Industrial Ethernet / PROFINET Industrial Ethernet System Manual (<https://support.industry.siemens.com/cs/ww/en/view/27069465>)
  - Industrial Ethernet / PROFINET Passive Network Components System Manual (<https://support.industry.siemens.com/cs/ww/en/view/84922825>)

## SIMATIC NET manuals

You will find the SIMATIC NET manuals here:

- On the data medium that ships with some products:
  - Product CD / product DVD
  - SIMATIC NET Manual Collection
- On the Internet pages of Siemens Industry Online Support (<https://support.industry.siemens.com/cs/ww/en/ps/15247>).

## SIMATIC NET glossary

Explanations of many of the specialist terms used in this documentation can be found in the SIMATIC NET glossary.

You will find the SIMATIC NET glossary here:

- SIMATIC NET Manual Collection or product DVD  
The DVD ships with certain SIMATIC NET products.
- On the Internet under the following address:  
50305045 (<https://support.industry.siemens.com/cs/ww/en/view/50305045>)

## Security information

Siemens provides products and solutions with industrial security functions that support the secure operation of plants, systems, machines and networks.

In order to protect plants, systems, machines and networks against cyber threats, it is necessary to implement – and continuously maintain – a holistic, state-of-the-art industrial security concept. Siemens' products and solutions constitute one element of such a concept.

Customers are responsible for preventing unauthorized access to their plants, systems, machines and networks. Such systems, machines and components should only be connected to an enterprise network or the internet if and to the extent such a connection is necessary and only when appropriate security measures (e.g. firewalls and/or network segmentation) are in place.

For additional information on industrial security measures that may be implemented, please visit <https://www.siemens.com/industrialsecurity> (<https://www.siemens.com/industrialsecurity>)

Siemens' products and solutions undergo continuous development to make them more secure. Siemens strongly recommends that product updates are applied as soon as they are available and that the latest product versions are used. Use of product versions that are no longer supported, and failure to apply the latest updates may increase customers' exposure to cyber threats.

To stay informed about product updates, subscribe to the Siemens Industrial Security RSS Feed under <https://www.siemens.com/industrialsecurity> (<https://www.siemens.com/industrialsecurity>)

## Catalogs

You will find the article numbers for the Siemens products of relevance here in the following catalogs:

- SIMATIC NET Industrial Communication / Industrial Identification, catalog IK PI
- SIMATIC Products for Totally Integrated Automation and Micro Automation, catalog ST 70
- Industry Mall - catalog and ordering system for automation and drive technology, Online catalog (<https://mall.industry.siemens.com/goos/WelcomePage.aspx?regionUrl=/de&language=en>)

You can request the catalogs and additional information from your Siemens representative.

## Device defective

If a fault develops, send the device to your SIEMENS representative for repair. Repairs on-site are not possible.

## Recycling and disposal



The products are low in pollutants, can be recycled and meet the requirements of the WEEE directive 2012/19/EU for the disposal of electrical and electronic equipment.

Do not dispose of the products at public disposal sites.

For environmentally friendly recycling and the disposal of your old device contact a certified disposal company for electronic scrap or your Siemens contact (Product return (<https://support.industry.siemens.com/cs/ww/en/view/109479891>)).

Note the different national regulations.

## Trademarks

The following and possibly other names not identified by the registered trademark sign ® are registered trademarks of Siemens AG:

SCALANCE, C-PLUG, OLM

## Electrostatic discharge



### NOTICE

#### Electrostatic sensitive devices (ESD)

Electronic modules contain electrostatic sensitive components

These components can easily be destroyed if handled incorrectly.

Note the following instructions to avoid damage.

- Touch electronic modules only when you absolutely need to work on them.
- If electronic modules need to be touched, the body of the person involved must first be electrostatically discharged and grounded.
- Do not bring electronic modules in contact with electrically isolating materials such as plastic film, isolating table top pads or clothing made of synthetic fibers.
- Place the modules only on conductive surfaces.
- Pack, store and transport electronic modules and components only in conductive packaging such as metalized plastic or metal containers, conductive foam or household aluminum foil.



# Safety notices

## Read the safety notices

Note the following safety notices. These relate to the entire working life of the device.

You should also read the safety notices relating to handling in the individual sections, particularly in the sections "Installation" and "Connecting up".

**CAUTION**

To prevent injury and damage, read the manual before using the device.

## Safety notices on use in hazardous areas

### General safety notices relating to protection against explosion

**WARNING****EXPLOSION HAZARD**

Do not open the device when the supply voltage is turned on.

### Safety instructions for use in hazardous locations according to UL/FM HazLoc

If you use the device under UL or FM HazLoc conditions, you must also adhere to the following safety instructions in addition to the general safety instructions for protection against explosion:

This equipment is suitable for use in Class I, Division 2, Groups A, B, C and D or non-hazardous locations only.

This equipment is suitable for use in Class I, Zone 2, Group IIC or non-hazardous locations only.



## Network topologies

Switching technology allows extensive networks to be set up with numerous nodes and simplifies network expansion.

### Which topologies can be implemented?

Using the IE switches of the SCALANCE XB-000 product line, you can implement star topologies.

---

#### Note

Keep to the maximum permitted cable lengths of the devices you are using. You will find the permitted cable lengths in the section "Technical specifications (Page 57)".

---

### Star topology

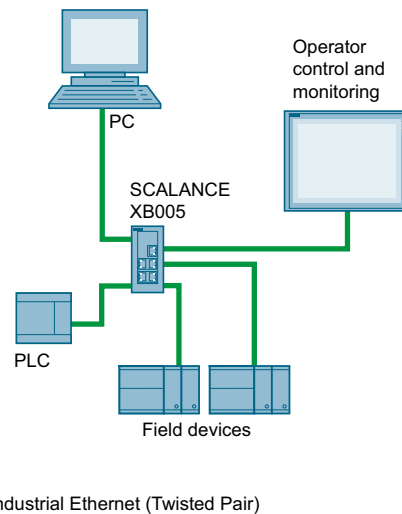

Figure 3-1 Example of an electrical star topology with SCALANCE XB005

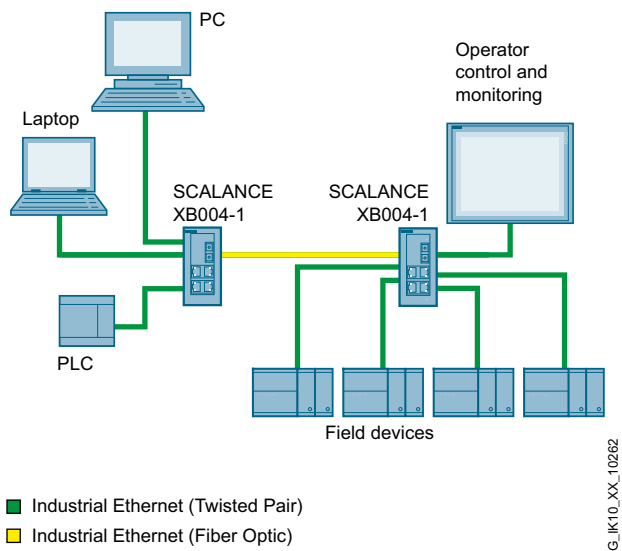

Figure 3-2 Example of an electrical/optical star topology with SCALANCE XB004-1

## Description of the device

### 4.1 Purpose

#### What is possible?

The IE switches of the SCALANCE XB-000 product line allow the cost-effective installation of Industrial Ethernet bus and star structures with switching functionality.

With the following IE switches, there are also electrical/optical media transitions:

- SCALANCE XB004-1
- SCALANCE XB004-2
- SCALANCE XB004-1LD
- SCALANCE XB004-2LD
- SCALANCE XB004-1G
- SCALANCE XB004-1LDG

---

#### Note

It is not possible to use IE switches of the SCALANCE XB-000 product line in a redundant ring because they do not support redundancy.

---

#### Note

If devices are supplied over long 24 V power supply lines or networks, measures are necessary to prevent interference by strong electromagnetic pulses on the supply lines. These can result, for example, due to lightning or switching of large inductive loads.

One of the tests used to attest the immunity of these devices to electromagnetic interference is the "surge immunity test" according to EN 61000-4-5. This test requires overvoltage protection for the power supply lines. A suitable device is, for example, the Dehn Blitzductor BVT AVD 24 V type no. 918 422 or a comparable protective element. An example of a suitable device for AC operation is the Blitzductor BXT ML2 BDS 48, art. no. 920 245, in combination with the basic unit BXT BAS, art. no. 920 300, or a comparable protective element.

Manufacturer:

DEHN+SÖHNE GmbH+Co.KG Hans Dehn Str.1 Postfach 1640 D-92306 Neumarkt, Germany

---

## 4.2 Product overview

Table 4-1 Overview of the product characteristics

	XB004-1	XB004-2	XB004-1LD	XB004-2LD	XB005	XB008	XB004-1G	XB004-1LDG	XB005G	XB008G
SIMATIC environment	+	+	+	+	+	+	+	+	+	+
Diagnostics LED	+	+	+	+	+	+	+	+	+	+
24 VDC	+	+	+	+	+	+	+	+	+	+
24 VAC	+ <sup>1)</sup>	-	+ <sup>1)</sup>	-	+ <sup>1)</sup>	+ <sup>1)</sup>	-	-	-	-
2 x 24 VDC	-	-	-	-	-	-	-	-	-	-
Signaling contact + on-site operation	-	-	-	-	-	-	-	-	-	-
Diagnostics: Web, SNMP, PROFINET	-	-	-	-	-	-	-	-	-	-
C-PLUG	-	-	-	-	-	-	-	-	-	-
Ring redundancy with RM	-	-	-	-	-	-	-	-	-	-
Passive ring redundancy	-	-	-	-	-	-	-	-	-	-
Standby redundancy	-	-	-	-	-	-	-	-	-	-
IRT capability	-	-	-	-	-	-	-	-	-	-
Fast learning	-	-	-	-	-	-	-	-	-	-
Passive listening	-	-	-	-	-	-	-	-	-	-
Log table	-	-	-	-	-	-	-	-	-	-
SNTP + SICLOCK	-	-	-	-	-	-	-	-	-	-
Cut Through	-	-	-	-	-	-	-	-	-	-

<sup>1)</sup> Note the hardware version (Page 57) or the article number.

Table 4-2 Overview of the connection options

	XB004-1	XB004-2	XB004-1LD	XB004-2LD	XB005	XB008	XB004-1G	XB004-1LDG	XB005G	XB008G
TP (RJ-45) Fast Ethernet 10 / 100 Mbps	4	4	4	4	5	8	-	-	-	-
Fiber multi-mode (SC) Fast Ethernet 100 Mbps	1	2	0	0	-	-	-	-	-	-
Single-mode fiber (SC) Fast Ethernet 100 Mbps	0	0	1	2	-	-	-	-	-	-

	XB004-1	XB004-2	XB004-1LD	XB004-2LD	XB005	XB008	XB004-1G	XB004-1LDG	XB005G	XB008G
TP (RJ-45) Gigabit Ethernet 10 / 100 / 1000 Mbps	-	-	-	-	-	-	4	4	5	8
Fiber multi-mode (SC) Gigabit Ethernet 1000 Mbps	-	-	-	-	-	-	1	0	-	-
Fiber single mode (SC) Gigabit Ethernet 1000 Mbps	-	-	-	-	-	-	0	1	-	-

## Unpacking and checking

<p> <b>WARNING</b></p> <p><b>Do not use any parts that show evidence of damage</b></p> <p>If you use damaged parts, there is no guarantee that the device will function according to the specification.</p> <p>If you use damaged parts, this can lead to the following problems:</p> <ul style="list-style-type: none"> <li>• Injury to persons</li> <li>• Loss of the approvals</li> <li>• Violation of the EMC regulations</li> <li>• Damage to the device and other components</li> </ul> <p>Use only undamaged parts.</p>
---

1. Make sure that the package is complete.
2. Check all the parts for transport damage.

## Components of the product

The following components are supplied with a SCALANCE XB-000:

- IE switch SCALANCE XB-000
- 3-pin terminal block (power supply)
- Product information

## 4.2 Product overview

## Accessories

Component	Length	Packaging unit	Order number	Suitable for XB-000 Fast Ethernet	Suitable for XB-000G Gigabit Ethernet
IE TP Cord RJ-45/RJ-45, CAT 6, TP cable 4x2, fitted with 2 RJ-45 plugs	0.5 m	1	6XV1870-3QE50	+	+
IE TP Cord RJ-45/RJ-45, CAT 6, TP cable 4x2, fitted with 2 RJ-45 plugs	1 m	1	6XV1870-3QH10	+	+
IE TP Cord RJ-45/RJ-45, CAT 6, TP cable 4x2, fitted with 2 RJ-45 plugs	2 m	1	6XV1870-3QH20	+	+
IE TP Cord RJ-45/RJ-45, CAT 6, TP cable 4x2, fitted with 2 RJ-45 plugs	6 m	1	6XV1870-3QH60	+	+
IE TP Cord RJ-45/RJ-45, CAT 6, TP cable 4x2, fitted with 2 RJ-45 plugs	10 m	1	6XV1870-3QN10	+	+
IE FC Stripping Tool	-	1	6GK1901-1GA00	+	+
IE FC blade cassettes (5 mm)	-	1	6GK1901-1GB01	+	+
IE FC TP standard cable GP 2x2	-	1	6XV1840-2AH10	+	-
IE FC TP standard cable GP 4x2	-	1	6XV1878-2A	(+)	+
IE FC TP trailing cable	-	1	6XV1840-3AH10	+	-
IE FC TP marine cable	-	1	6XV1840-4AH10	+	-
IE FC TP trailing cable GP	-	1	6XV1870-2D	+	-
IE FC TP flexible cable GP 2x2	-	1	6XV1870-2B	+	-
IE FC TP flexible cable GP 4x2	-	1	6XV1878-2B	(+)	+
IE FC TP FRNC cable GP	-	1	6XV1871-2F	+	-
IE FC TP festoon cable GP	-	1	6XV1871-2S	+	-
IE FC TP food cable	-	1	6XV1871-2L	+	-
IE TP torsion cable	-	1	6XV1870-2F	+	-
FO standard cable 50/125, fitted with 2x2 SC connectors, pulling aid	80 m	1	6XV1873-6AN80	+	+
FO standard cable 50/125, fitted with 2x2 SC connectors, pulling aid	100 m	1	6XV1873-6AT10	+	+
FO standard cable 50/125, fitted with 2x2 SC connectors, pulling aid	150 m	1	6XV1873-6AT15	+	+
FO standard cable 50/125, fitted with 2x2 SC connectors, pulling aid	200 m	1	6XV1873-6AT20	+	+
FO standard cable 50/125, fitted with 2x2 SC connectors, pulling aid	300 m	1	6XV1873-6AT30	+	+
FO standard cable GP (50/125)	-	1	6XV1873-2A	+	+
FO trailing cable (50/125)	-	1	6XV1873-2C	+	+
FO trailing cable GP (50/125)	-	1	6XV1873-2D	+	+
FO ground cable (50/125)	-	1	6XV1873-2G	+	+
FO FRNC cable (50/125)	-	1	6XV1873-2B	+	+
IE FC RJ-45 Plug 180 2x2	-	1	6GK1901-1BB10-2AA0	+	-
IE FC RJ-45 Plug 4x2	-	1	6GK1901-1BB11-2AA0	(+)	+
IE FC RJ-45 Plug 180 2x2	-	10	6GK1901-1BB10-2AB0	+	-



Component	Length	Packaging unit	Order number	Suitable for XB-000 Fast Ethernet	Suitable for XB-000G Gigabit Ethernet
IE FC RJ-45 Plug 4x2	-	10	6GK1901-1BB11-2AB0	(+)	+
IE FC RJ-45 Plug 180 2x2	-	50	6GK1901-1BB10-2AE0	+	-
IE FC RJ-45 Plug 4x2	-	50	6GK1901-1BB11-2AE0	(+)	+

**Note**

For the devices with Fast Ethernet, you can use cables and connectors with 2x2 lines. The use of 4x2 lines is also possible but not absolutely necessary. These products are indicated by (+).

## 4.3 Product properties and device views

### 4.3.1 SCALANCE XB004-1

#### Possible attachments

The SCALANCE XB004-1 has four RJ-45 jacks and an SC socket for the connection of end devices or other network segments.

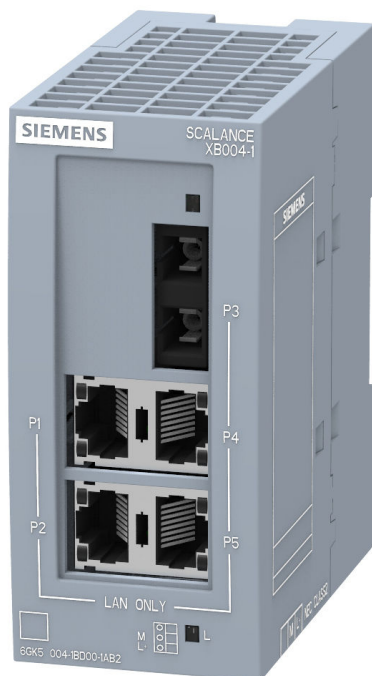

Figure 4-1 SCALANCE XB004-1

### 4.3.2 SCALANCE XB004-2

#### Possible attachments

The SCALANCE XB004-2 has four RJ-45 jacks and two SC sockets for the connection of end devices or other network segments.



Figure 4-2 SCALANCE XB004-2

### 4.3.3 SCALANCE XB004-1LD

#### Possible attachments

The SCALANCE XB004-1LD has four RJ-45 jacks and an SC socket for the connection of end devices or other network segments.



Figure 4-3 SCALANCE XB004-1LD

#### 4.3.4 SCALANCE XB004-2LD

##### Possible connections

The SCALANCE XB004-2LD has four RJ-45 jacks and two SC sockets for the connection of end devices or other network segments.



Figure 4-4 SCALANCE XB004-2LD

### 4.3.5 SCALANCE XB005

#### Possible connections

The SCALANCE XB005 has five RJ-45 jacks for connection of end devices or other network segments.

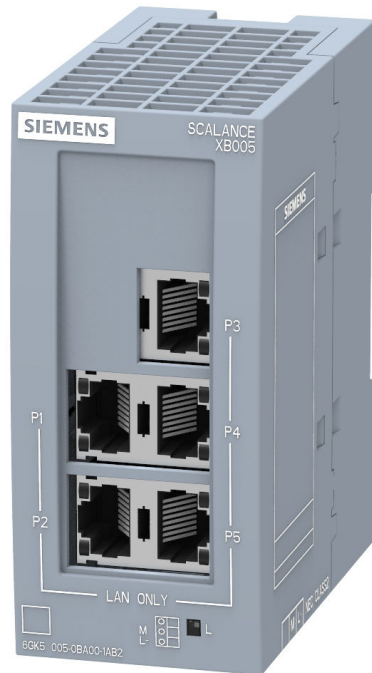

Figure 4-5 SCALANCE XB005

### 4.3.6 SCALANCE XB008

#### Possible connections

The SCALANCE XB008 has eight RJ-45 jacks for the connection of end devices or other network segments.



Figure 4-6 SCALANCE XB008

### 4.3.7 SCALANCE XB004-1G

#### Possible attachments

The SCALANCE XB004-1G has four RJ-45 jacks capable of Gigabit and an SC socket for the connection of end devices or other network segments.



Figure 4-7 SCALANCE XB004-1G

### 4.3.8 SCALANCE XB004-1LDG

#### Possible attachments

The SCALANCE XB004-1LDG has four RJ-45 jacks capable of Gigabit and an SC socket for the connection of end devices or other network segments.



Figure 4-8 SCALANCE XB004-1LDG



### 4.3.9 SCALANCE XB005G

#### Possible attachments

The SCALANCE XB005G has five RJ-45 jacks capable of Gigabit for connection of end devices or other network segments.



Figure 4-9 SCALANCE XB005G

### 4.3.10 SCALANCE XB008G

#### Possible attachments

The SCALANCE XB008G has eight RJ-45 jacks capable of Gigabit for the connection of end devices or other network segments.



Figure 4-10 SCALANCE XB008G

## 4.4 TP ports (twisted pair)

---

#### Note

##### Strain relief for the Ethernet cables

In order to avoid mechanical stress on the Ethernet cables and resulting interruption of the contact, fasten the cables at a short distance from the connector using a cable guide or busbar.

---

### 4.4.1 Pin assignment

With IE switches of the SCALANCE XB-000 product line, the twisted-pair ports are designed as RJ-45 jacks with MDI-X pin assignment (Medium Dependent Interface Autocrossover) of a network component.

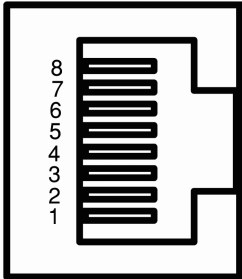

Pin number	Assignment for SCALANCE XB-000	Assignment for SCALANCE XB-000G
Pin 8	n. c.	D4-
Pin 7	n. c.	D4+
Pin 6	TD-	D2-
Pin 5	n. c.	D3-
Pin 4	n. c.	D3+
Pin 3	TD+	D2+
Pin 2	RD-	D1-
Pin 1	RD+	D1+

#### Note

TP cords or TP-XP cords with a maximum length of 10 m can be connected to the TP port with the RJ-45 jack.

With the IE FC cables and IE FC RJ-45 plug 180, an overall cable length of a maximum of 100 m is permitted between two devices depending on the cable type.

### 4.4.2 Functions

#### Autonegotiation

With the autonegotiation mechanism, repeaters and end devices can automatically determine the transmission speed and the transmission mode of the partner port. This makes it possible to configure different devices automatically.

#### 4.4 TP ports (twisted pair)

Two components connected to a link segment can exchange information about the data transfer and can adapt their settings to each other. The mode with the highest possible speed is set.

---

**Note**

Devices not supporting autonegotiation must be set to 1000 Mbps/ half duplex, 100 Mbps/ half duplex or 10 Mbps half duplex.

---

**Note**

The IE switches of the SCALANCE XB-000 product line are plug-and-play devices that require no settings during commissioning.

---

#### Auto polarity exchange

If the pair of receiving cables is connected incorrectly (RD+ and RD- interchanged), the polarity is adapted automatically.

#### MDI / MDI-X autocrossover function

With the MDI/MDI-X autocrossover function, the send and receive contacts of an Ethernet port are assigned automatically. The assignment depends on the cable with which the communications partner is connected. This means that it does not matter whether the port is connected using a patch cable or crossover cable. This prevents malfunctions resulting from mismatching send and receive lines. This makes installation much easier for the user.

The IE switches of the SCALANCE XB-000 product line all support the MDI/MDIX autocrossover function.

---

**Note**

Please note that the direct connection of two ports on the IE switch or accidental connection over several IE switches causes an illegal loop. Such a loop can lead to network overload and network failures.

---

#### 4.4.3 Insulation between the TP ports

The insulation between the TP ports is based on the number of TP ports.

The SCALANCE XB004-1 group includes the following devices:

- SCALANCE XB004-1
- SCALANCE XB004-1LD
- SCALANCE XB004-1G
- SCALANCE XB004-1LDG

The SCALANCEXB004-2 group includes the following devices:

- SCALANCE XB004-2
- SCALANCE XB004-2LD

The SCALANCE XB005 group includes the following devices:

- SCALANCE XB005
- SCALANCE XB005G

The SCALANCE XB008 group includes the following devices:

- SCALANCE XB008
- SCALANCE XB008G

### **SCALANCE XB004-1**

There are two TP port groups:

Group1: P1 and P4

Group2: P2 and P5

Between ports of different port groups, an insulation voltage of 1.5 kV is adhered to (corresponds to IEEE802.3, Chapter 33.4.1.1, Environment B), e.g. between P1 and P2.

The requirements for Environment A are met between ports of the same group, e.g. between P1 and P4.

### **SCALANCE XB004-2**

There are two TP port groups:

Group1: P2 and P5

Group2: P3 and P6

Between ports of different port groups, an insulation voltage of 1.5 kV is adhered to (corresponds to IEEE802.3, Chapter 33.4.1.1, Environment B), e.g. between P2 and P3.

The requirements for Environment A are met between ports of the same group, e.g. between P2 and P5.

### **SCALANCE XB005**

There are three TP port groups:

Group1: P1 and P4

Group2: P2 and P5

Group3: P3

Between ports of different port groups, an insulation voltage of 1.5 kV is adhered to (corresponds to IEEE802.3, Chapter 33.4.1.1, Environment B), e.g. between P1 and P2.

The requirements for Environment A are met between ports of the same group, e.g. between P2 and P5.

## SCALANCE XB008

There are four TP port groups:

Group1: P1 and P5

Group2: P2 and P6

Group3: P3 and P7

Group4: P4 and P8

Between ports of different port groups, an insulation voltage of 1.5 kV is adhered to (corresponds to IEEE802.3, Chapter 33.4.1.1, Environment B), e.g. between P2 and P4.

The requirements for Environment A are met between ports of the same group, e.g. between P1 and P5.

## 4.5 FO port (fiber optic)

### NOTICE

#### Failure of the data traffic due to contamination of optical plug-in connections

Optical sockets and plugs are sensitive to contamination of the end face. Contamination can lead to the failure of the optical transmission network. Take the following precautions to avoid functional impairments:

- Clean the end face of field-assembled connectors carefully before connecting. No residues of processing may remain on the connector.
- Only remove the dust caps of optical transceivers and pre-configured cables shortly before connecting the cables.
- Close unused optical sockets and plugs as well as pluggable transceivers and slots with the supplied protective caps.

### 4.5.1 SCALANCE XB004-1

#### Transmission rate

The transmission rate of the optical Fast Ethernet port is 100 Mbps.

#### Transmission mode

The transmission mode for 100Base-FX is specified in the IEEE 802.3 standard.

Since the full duplex mode and the transmission rate cannot be modified for optical transmission, autonegotiation cannot be used.

### Transmission medium

Data transmission is over multimode fiber-optic cable (FOC). The wavelength is 1310 nm. The FO cables are compatible with multimode FO cables with 1300 nm.

Multimode fiber-optic cables are used with a core of 50 or 62.5  $\mu\text{m}$ ; the light source is an LED.

The outer diameter of the FOC is 125  $\mu\text{m}$ .

### Range

The maximum transmission range (segment length) with a signal attenuation of the fiber-optic cable of  $\leq 1$  dB/km at 1310 nm is:

- with 62.5/125  $\mu\text{m}$  fiber multimode SIMATIC NET cable: 4 km
- with 50.0/125  $\mu\text{m}$  fiber multimode SIMATIC NET cable: 5 km

### Connectors

The cables are connected to SC sockets.

## 4.5.2 SCALANCE XB004-2

### Transmission rate

The transmission speed of the optical Fast Ethernet ports is 100 Mbps.

### Transmission mode

The transmission mode for 100Base-FX is specified in the IEEE 802.3 standard.

Since the full duplex mode and the transmission rate cannot be modified for optical transmission, autonegotiation cannot be used.

### Transmission medium

Data transmission is over multimode fiber-optic cable (FOC). The wavelength is 1310 nm. The FO cables are compatible with multimode FO cables with 1300 nm.

Multimode fiber-optic cables are used with a core of 50 or 62.5  $\mu\text{m}$ ; the light source is an LED.

The outer diameter of the FOC is 125  $\mu\text{m}$ .

### Range

The maximum transmission range (segment length) with a signal attenuation of the fiber-optic cable of  $\leq 1$  dB/km at 1310 nm is:

- with 62.5/125  $\mu\text{m}$  fiber multimode SIMATIC NET cable: 4 km
- with 50.0/125  $\mu\text{m}$  fiber multimode SIMATIC NET cable: 5 km

#### 4.5 FO port (fiber optic)

##### Connectors

The cables are connected to SC sockets.

### 4.5.3 SCALANCE XB004-1LD

##### Transmission rate

The transmission rate of the optical Fast Ethernet port is 100 Mbps.

##### Transmission mode

The transmission mode for 100Base-LX is specified in the IEEE 802.3 standard.

Since the full duplex mode and the transmission rate cannot be modified for optical transmission, autonegotiation cannot be used.

##### Transmission medium

Data transmission is over single-mode fiber-optic cable (FO cable). The transceiver wavelength is 1310 nm. The FO cables are compatible with single-mode FO cables with 1300 nm.

Single-mode fiber-optic cables with a core diameter of 9 µm are used. The outer diameter of the FOC is 125 µm.

##### Sender

The light source is an "eye safe" class 1 laser with a wavelength of 1310 nm.

##### Range

The maximum transmission range (segment length) is 26 km for a signal attenuation of the fiber-optic cable of  $\leq 0.5$  dB/km.

##### Connectors

The cables are connected to SC sockets.

### 4.5.4 SCALANCE XB004-2LD

##### Transmission rate

The transmission speed of the optical Fast Ethernet ports is 100 Mbps.



### Transmission mode

The transmission mode for 100Base-LX is specified in the IEEE 802.3 standard.

Since the full duplex mode and the transmission rate cannot be modified for optical transmission, autonegotiation cannot be used.

### Transmission medium

Data transmission is over single-mode fiber-optic cable (FO cable). The transceiver wavelength is 1310 nm. The FO cables are compatible with single-mode FO cables with 1300 nm.

Single-mode fiber-optic cables with a core diameter of 9 µm are used. The outer diameter of the FOC is 125 µm.

### Sender

The light source is an "eye safe" class 1 laser with a wavelength of 1310 nm.

### Range

The maximum transmission range (segment length) is 26 km for a signal attenuation of the fiber-optic cable of  $\leq 0.5$  dB/km.

### Connectors

The cables are connected to SC sockets.

## 4.5.5 SCALANCE XB004-1G

### Transmission rate

The transmission rate of the optical Fast Ethernet port is 1000 Mbps.

### Transmission mode

The transmission mode for 1000Base-SX is specified in the IEEE 802.3z standard.

Since the full duplex mode and the transmission rate cannot be modified for optical transmission, autonegotiation cannot be used.

### Transmission medium

Data transmission is over multimode fiber-optic cable (FOC). The wavelength is 850 nm.

Multimode fiber-optic cable with a core diameter of 50 µm is used. Fiber-optic cables with a core diameter of 62.5 µm are not recommended for 1000Base-SX because this reduces the maximum segment length drastically.

#### 4.5 FO port (fiber optic)

The outer diameter of the FOC is 125 µm.

#### Sender

The light source is an "eye safe" class 1 laser with a wavelength of 850 nm (EN60825-1).

#### Range

Depending on the fiber-optic cable used, the maximum transmission range (segment length) is 750 m when using SIMATIC NET fiber-optic multimode cable with SC duplex connectors or 550 m when using a standard multimode FO cable.

#### Connectors

The cables are connected to SC sockets.

### 4.5.6 SCALANCE XB004-1LDG

#### Transmission rate

The transmission rate of the optical Fast Ethernet port is 1000 Mbps.

#### Transmission mode

The transmission mode for 1000Base-LH is specified in the IEEE 802.3z standard.

Since the full duplex mode and the transmission rate cannot be modified for optical transmission, autonegotiation cannot be used.

#### Transmission medium

Data transmission is over single-mode fiber-optic cable (FO cable). The transceiver wavelength is 1310 nm. The FO cables are compatible with single-mode FO cables with 1300 nm.

Single-mode fiber-optic cables with a core diameter of 9 µm are used. The outer diameter of the FOC is 125 µm.

#### Sender

The light source is an "eye safe" class 1 laser with a wavelength of 1310 nm.

#### Range

The maximum transmission range (segment length) is 10 km for a signal attenuation of the fiber-optic cable of  $\leq 0.5$  dB/km.

## Connectors

The cables are connected to SC sockets.

## 4.6 LEDs

### Power LED 'L' (green LED)

The power LED shows the status of the power supply.

LED color	LED status	Meaning
Green	Lit	Power supply is connected
-	Off	Power supply is not connected or the applied voltage is too low. Refer also to the section "Possible sources of errors and eliminating errors (Page 55)"

### Port LED 'P' (green LED)

The port LEDs indicate the status of the ports. The port LEDs are located directly on the port.

LED color	LED status	Meaning
Green	Lit	Link exists, no data reception at port
Green	Flashing	Link exists, data reception at port
Green	Flashing / flash on and off in sequence	Test phase during power on

4.6 LEDs

# Assembly and disassembly

## 5.1 Safety notices for installation

### Safety notices

When installing the device, keep to the safety notices listed below.

 <b>WARNING</b>
If the device is installed in a cabinet, the inner temperature of the cabinet corresponds to the ambient temperature of the device.

 <b>WARNING</b>
If the cable or conduit entry point exceeds 70 °C or the branching point of conductors exceeds 80 °C, special precautions must be taken. If the equipment is operated in an air ambient in excess of 60 °C, only use cables with admitted maximum operating temperature of at least 80 °C.

<b>NOTICE</b>
<b>Improper mounting</b>
Improper mounting may damage the device or impair its operation.
<ul style="list-style-type: none"> <li>• Before mounting the device, always ensure that there is no visible damage to the device.</li> <li>• Mount the device using suitable tools. Observe the information in the respective section about mounting.</li> </ul>

### Safety notices on use in hazardous areas

#### General safety notices relating to protection against explosion

 <b>WARNING</b>
<b>EXPLOSION HAZARD</b>
Replacing components may impair suitability for Class 1, Division 2 or Zone 2.

 <b>WARNING</b>
The device is intended for indoor use only.

 **WARNING**

The device may only be operated in an environment of contamination class 1 or 2 (see EN/IEC 60664-1, GB/T 16935.1).

 **WARNING**

Substitution of components may impair suitability of the equipment.

 **WARNING**

When used in hazardous environments corresponding to Class I, Division 2 or Class I, Zone 2, the device must be installed in a cabinet or a suitable enclosure.

**Notes for use in hazardous locations according to ATEX, IECEx, UKEX and CCC Ex**

If you use the device under ATEX, IECEx, UKEX or CCC Ex conditions you must also keep to the following safety instructions in addition to the general safety instructions for protection against explosion:

 **WARNING**

To comply with EU Directive 2014/34 EU (ATEX 114), UK-Regulation SI 2016/1107 or the conditions of IECEx or CCC-Ex, the housing or cabinet must meet the requirements of at least IP54 (according to EN/IEC 60529, GB/T 4208) in compliance with EN IEC/IEC 60079-7, GB 3836.8.

 **WARNING**

The equipment shall only be used in an area of not more than pollution degree 2, as defined in EN/IEC 60664-1, GB/T 16935.1.

**Safety notices when using according to FM**

If you use the device under FM conditions you must also keep to the following safety notices in addition to the general safety notices for protection against explosion:

 **WARNING**

**EXPLOSION HAZARD**

The equipment is intended to be installed within an enclosure/control cabinet. The inner service temperature of the enclosure/control cabinet corresponds to the ambient temperature of the module. Use cables with a maximum permitted operating temperature of at least 20 °C higher than the maximum ambient temperature.

 **WARNING**

Wall mounting is only permitted if the requirements for the housing, the installation regulations, the clearance and separating regulations for the control cabinets or housings are adhered to. The control cabinet cover or housing must be secured so that it can only be opened with a tool. An appropriate strain-relief assembly for the cable must be used.

 **WARNING**

Wall mounting outside of the control cabinet or housing does not fulfill the requirements of the FM approval.

**Note**

You must not install the device on a wall in hazardous areas.

**Safety notices when using the device as industrial control equipment according to UL 61010-2-201**

If you use the device under UL 61010-2-201 conditions you must also keep to the following safety notices in addition to the general safety notices for protection against explosion:

 **WARNING**

**Open equipment**

The devices are "open equipment" according to the standard IEC 61010-2-201 or UL 61010-2-201 / CSA C22.2 No. 61010-2-201. To fulfill requirements for safe operation with regard to mechanical stability, flame retardation, stability, and protection against contact, the following alternative types of installation are specified:

- Installation in a suitable cabinet.
- Installation in a suitable enclosure.
- Installation in a suitably equipped, enclosed control room.

 **WARNING**

If the cable or housing socket exceeds 70 °C or the branching point of the cables exceeds 60 °C, special precautions must be taken. If the equipment is operated in an air ambient in excess of 40 °C, only use cables with admitted maximum operating temperature of at least 80 °C.

## 5.2 Types of installation

The devices can be installed in the following ways:

- Installation on a 35 mm DIN rail
- Wall mounting

 <b>WARNING</b>
--

If the module is operated in an ambient temperature between 50 °C and 60 °C, the temperature of the module housing may be higher than 60 °C. The device must therefore be installed so that it is only accessible to service personnel or users that are aware of the reason for restricted access and the required safety measures at an ambient temperature of 50 °C to 60 °C.
--

### Installation clearance

Keep to the minimum clearances so that the convection ventilation of the device is not blocked.

- Below at least 10 cm
- Above at least 10 cm

### See also

SIMATIC NET Industrial Ethernet TP and Fiber Optic Networks (<http://support.automation.siemens.com/WW/view/en/8763736>)



## 5.3 Fixing onto standard mounting rails

### Mounting

To install the device on a 35 mm DIN rail, follow the steps below:

1. Place the housing guide of the device on the top edge of the DIN rail.
2. Push the device down against rail until it locks in place.

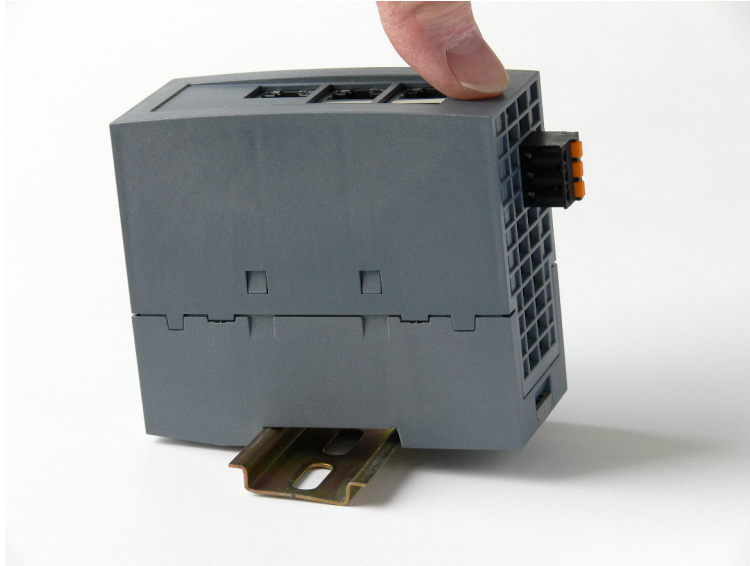

Figure 5-1 Installation on a 35 mm DIN rail

3. Fit the connectors for the power supply. See also section "Power supply (Page 49)"
4. Insert the terminal block into the sockets on the device.

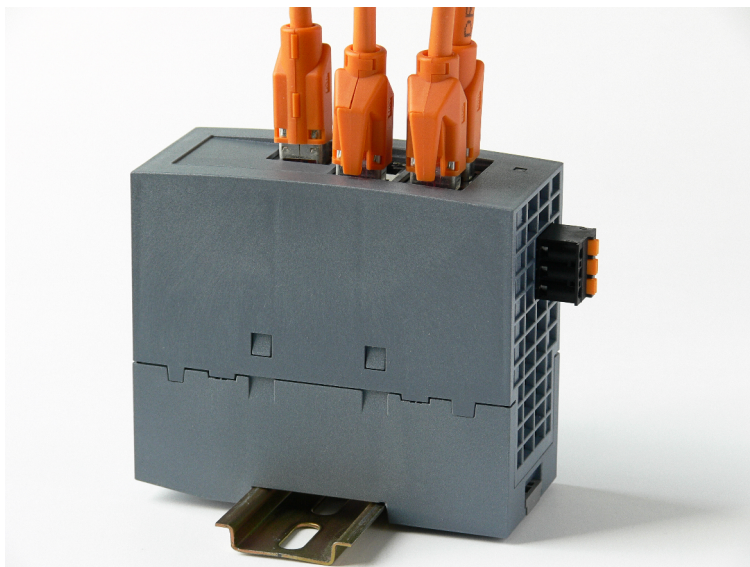

Figure 5-2 SCALANCE XB-000 mounted on the 35 mm DIN rail

## Removal

To remove the device from the DIN rail, follow the steps below:

1. Disconnect all connected cables.
2. Pull out the terminal block for the power supply.
3. Lever the catch on the underside of the device approximately 5 mm out using a screwdriver
4. Pull the lower part of the device away from the DIN rail.

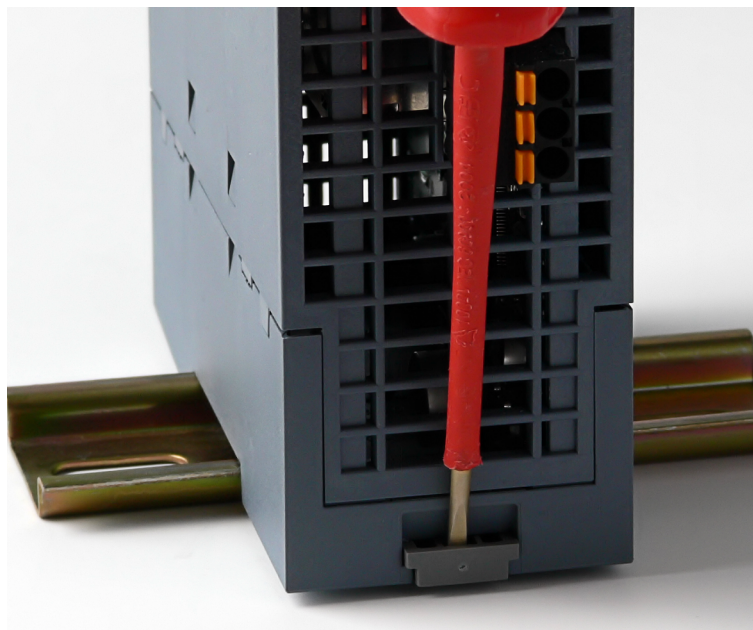

Figure 5-3 Removal from a 35 mm DIN rail

## 5.4 Wall mounting

To mount the device on a wall, you require the following:

- 2 wall plugs, 6 mm in diameter and 30 mm long
- 2 washers
- 2 screws 3.5 mm in diameter and 35 mm long

To mount the device on a wall, follow the steps below:

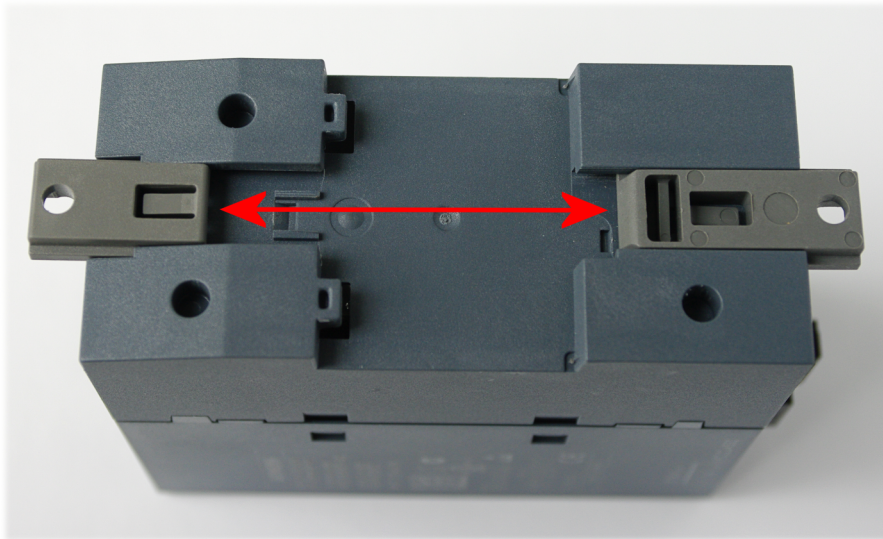

Figure 5-4 Preparation for wall mounting

1. Push out the two catches on the rear of the device.
2. Prepare the drill holes for wall mounting. For the precise dimensions, refer to the section "Dimension drawings (Page 89)".
3. Fit the connectors for the power supply. See also section "Power supply (Page 49)".
4. Insert the terminal block into the socket on the device.
5. Screw the device to the wall.



Figure 5-5 Wall mounting of the SCALANCE XB-000

---

**Note**

The wall mounting must be capable of supporting at least four times the weight of the device.

---

## 5.5 Disassembly



**WARNING**

**Improper disassembly**

Improper disassembly may result in a risk of explosion in hazardous areas.

For proper disassembly, observe the following:

- Before starting work, ensure that the electricity is switched off.
- Secure remaining connections so that no damage can occur as a result of disassembly if the system is accidentally started up.

## Connecting up

### 6.1 Safety when connecting up

#### Safety notices

When connecting up the device, keep to the safety notices listed below.

 <b>WARNING</b>
<p><b>Power supply</b></p> <p>The device is designed for operation with a directly connectable safety extra low voltage (SELV) from a limited power source (LPS).</p> <p>The power supply therefore needs to meet at least one of the following conditions:</p> <ul style="list-style-type: none"> <li>• Only safety extra low voltage (SELV) with limited power source (LPS) complying with IEC 60950-1 / EN 60950-1 / VDE 0805-1 or IEC 62368-1 / EN 62368-1 / VDE 62368-1 may be connected to the power supply terminals.</li> <li>• The power supply unit for the device must meet NEC Class 2 according to the National Electrical Code (r) (ANSI / NFPA 70).</li> </ul> <p>If the equipment is connected to a redundant power supply (two separate power supplies), both must meet these requirements.</p>

<p><b>NOTICE</b></p>
<p><b>Failure of the data traffic due to contamination of optical plug-in connections</b></p> <p>Optical sockets and plugs are sensitive to contamination of the end face. Contamination can lead to the failure of the optical transmission network. Take the following precautions to avoid functional impairments:</p> <ul style="list-style-type: none"> <li>• Clean the end face of field-assembled connectors carefully before connecting. No residues of processing may remain on the connector.</li> <li>• Only remove the dust caps of optical transceivers and pre-configured cables shortly before connecting the cables.</li> <li>• Close unused optical sockets and plugs as well as pluggable transceivers and slots with the supplied protective caps.</li> </ul>

## Safety notices on use in hazardous areas

### General safety notices relating to protection against explosion

 **WARNING**

**EXPLOSION HAZARD**

Do not connect or disconnect cables to or from the device when a flammable or combustible atmosphere is present.

 **WARNING**

**Unsuitable cables or connectors**

Risk of explosion in hazardous areas

- Only use connectors that meet the requirements of the relevant type of protection.
- If necessary, tighten the connector screw connections, device fastening screws, grounding screws, etc. according to the specified torques.
- Close unused cable openings for electrical connections.
- Check the cables for a tight fit after installation.

 **WARNING**

**Lack of equipotential bonding**

If there is no equipotential bonding in hazardous areas, there is a risk of explosion due to equalizing current or ignition sparks.

- Ensure that equipotential bonding is available for the device.

 **WARNING**

**Unprotected cable ends**

There is a risk of explosion due to unprotected cable ends in hazardous areas.

- Protect unused cable ends according to IEC/EN 60079-14.

 **WARNING**

**Improper installation of shielded cables**

There is a risk of explosion due to equalizing currents between the hazardous area and the non-hazardous area.

- Ground shielded cables that cross hazardous areas at one end only.
- Lay a potential equalization conductor when grounding at both ends.

**⚠ WARNING****Insufficient isolation of intrinsically safe and non-intrinsically safe circuits**

Risk of explosion in hazardous areas

- When connecting intrinsically safe and non-intrinsically safe circuits, ensure that the galvanic isolation is performed properly in compliance with local regulations (e.g. IEC 60079-14).
- Observe the device approvals applicable for your country.

**Notes for use in hazardous locations according to ATEX, IECEx, UKEX and CCC Ex**

If you use the device under ATEX, IECEx, UKEX or CCC Ex conditions you must also keep to the following safety instructions in addition to the general safety instructions for protection against explosion:

**⚠ WARNING****Transient overvoltages**

Take measures to prevent transient overvoltages of more than 40% of the rated voltage (or more than 119 V). This is the case if you only operate devices with SELV (safety extra-low voltage).

**⚠ WARNING****Suitable cables at high ambient temperatures in hazardous area**

At an ambient temperature of  $\geq 60$  °C, use heat-resistant cables designed for an ambient temperature at least 20 °C higher. The cable entries used on the enclosure must comply with the IP degree of protection required by EN IEC / IEC 60079-0, GB 3836.1.

**Safety instructions for use in hazardous locations according to UL/FM HazLoc**

If you use the device under UL or FM HazLoc conditions, you must also adhere to the following safety instructions in addition to the general safety instructions for protection against explosion:

**⚠ WARNING****EXPLOSION HAZARD**

You may only connect or disconnect cables carrying electricity when the power supply is switched off or when the device is in an area without inflammable gas concentrations.

**Safety notices when using the device according to ATEX/IECEx and FM**

If you use the device under ATEX/IECEx or FM conditions, you must also observe the following safety notices in addition to the general safety notices for protection against explosion:

**⚠ WARNING**  
 Do not remove or replace while circuit is live when a flammable or combustible atmosphere is present.

**⚠ WARNING**  
**Safety notice for connecting with a LAN ID (Local Area Network)**  
 A LAN or LAN segment with all the interconnected devices should be contained completely in a single low voltage power distribution in a building. The LAN is designed either for "Environment A" according to IEEE802.3 or "Environment 0" according to IEC TR 62102.  
 Do not connect any electrical connectors directly to the telephone network (telephone network voltage) or a WAN (Wide Area Network).

## 6.2 Wiring rules

When wiring use cables with the following AWG categories or cross sections.

Wiring rules for ...		Screw/spring-loaded terminals
connectable cable cross sections for flexible cables ...	without wire end ferrule	0.25 - 2.5 mm <sup>2</sup> AWG: 24 - 13
	with wire end ferrule with plastic ferrule**	0.25 - 2.5 mm <sup>2</sup> AWG: 24 - 13
	with wire end ferrule without plastic ferrule**	0.25 - 2.5 mm <sup>2</sup> AWG: 24 - 13
	with TWIN wire end ferrule**	0.5 - 1 mm <sup>2</sup> AWG: 20 - 17
Stripped length of the cable		8 - 10 mm
Wire end ferrule according to DIN 46228 with plastic ferrule**		8 - 10 mm

\* AWG: American Wire Gauge

\*\* See note "Wire end ferrules"

### Note

#### Wire end ferrules

Use crimp shapes with smooth surfaces, such as provided by square and trapeze shaped crimp cross sections.

Crimp shapes with wave-shaped profile are unsuitable.



## 6.3 Power supply

The power supply is connected via a plug-in terminal block with three terminals on the underside of the SCALANCE XB-000. The device is also connected to the functional grounding via this terminal block. You can find additional information in the section Grounding (Page 51). The power supply is non-floating.

---

### Note

The device can be disconnected from the power supply by removing the terminal block.

---

### Note

The devices correspond to overvoltage category I.

---

### 6.3.1 Power supply 24 VAC

You can operate the following devices as of a certain hardware version or with a certain article number (Page 57) with a 24 V AC power supply:

- XB004-1
- XB004-1LD
- XB005
- XB008 (6GK5 008-0BA10-1AB2)

The following figure shows the position of the power supply and the assignment of the terminal block.

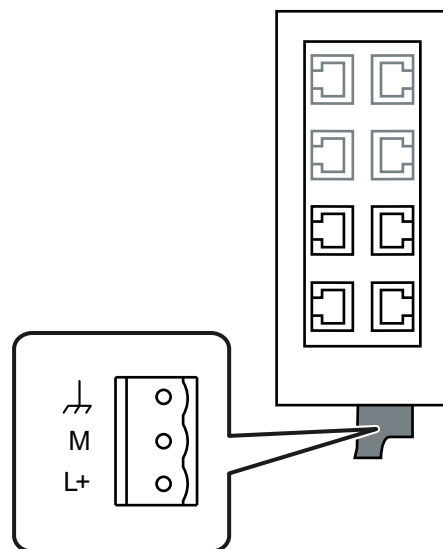

Pin number	Assignment
Pin 1	Functional ground

6.3 Power supply

Pin 2	M (24 VAC, 50/60 Hz)
Pin 3	L+ (24 VAC, 50/60 Hz)

 **WARNING**

**Incorrect power supply**

The power supply unit for supplying the devices must comply with NEC Class 2 or LPS (voltage range 19.2 - 28.8 V, current requirements 350 mA).

Do not operate the devices with AC voltages higher than 28.8 VAC.

**6.3.2 Power supply 24 VDC**

You can operate the following devices with a 24 V DC power supply:

- XB004-1
- XB004-2
- XB004-1LD
- XB004-2LD
- XB005
- XB008
- XB004-1G
- XB004-1LDG
- XB005G
- XB008G

The following figure shows the position of the power supply and the assignment of the terminal block.

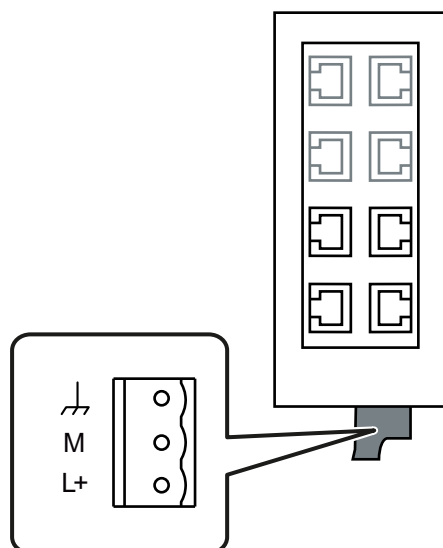

Pin number	Assignment
Pin 1	Functional ground
Pin 2	M (chassis ground)
Pin 3	L+ (24 VDC)

**⚠ WARNING**

**Incorrect power supply**

The power supply unit for supplying the devices must comply with NEC Class 2 or LPS (voltage range 19.2 - 28.8 V, current requirements 350 mA).

Do not operate the devices with DC voltages higher than 28.8 VDC.

Do not operate the device with an AC voltage:

- XB008 (6GK5 008-0BA00-1AB2)
- XB004-1G
- XB004-1LDG
- XB005G
- XB008G

## 6.4 Grounding

### Protective/functional ground

The connection of the reference potential surface with the protective earth system is normally in the cabinet close to the power feed-in. This earth conducts fault currents to ground safely and according to DIN/VDE 0100 is a protective earth to protect people, animals and property from too high contact voltages.

Apart from the protective earth, there is functional ground in the cabinet. According to EN60204-1 (DIN/VDE 0113 T1) electrical circuits must be grounded. The chassis (0 V) is grounded at one defined point. Here, once again the grounding is implemented with the lowest leakage resistance to ground in the vicinity of the power feed-in.

With automation components, functional ground also ensures interference-free operation of a controller. Via the functional ground, interference currents coupled in via the connecting cables and EMC interferences are discharged to ground.

### Functional grounding with SCALANCE XB-000

Grounding is not mandatory for operation of the SCALANCE XB-000 but it increases the resistance of the data transmission against interference. The functional ground must be implemented with low impedance.

Follow these steps to connect the functional ground:

1. Connect pin 1 of the terminal block of the power supply with a short cable ( $\leq 150$  mm) to the DIN rail.
2. Connect the DIN rail to the functional grounding in the control cabinet.

## 6.5 Twisted pair cable

### Recommendation

- Cable quality at least CAT 5
- Standard cables and IE FC RJ-45 Plug 180 connectors that can be assembled in the field for connection to the LAN over greater distances.
- To connect the device over a short distance, preassembled cables e.g. TP Cord RJ-45 0.5m

## 6.6 IE FC RJ-45 Plug 180

The rugged node connectors are designed for industry with PROFINET-compliant connectors and provide additional strain and bending relief with a locking mechanism on the casing.

### Fitting the IE FC RJ45 Plug 180 to the IE FC Standard Cable

You will find the notes on installation in the instructions that ship with the IE FC RJ45 Plug 180.

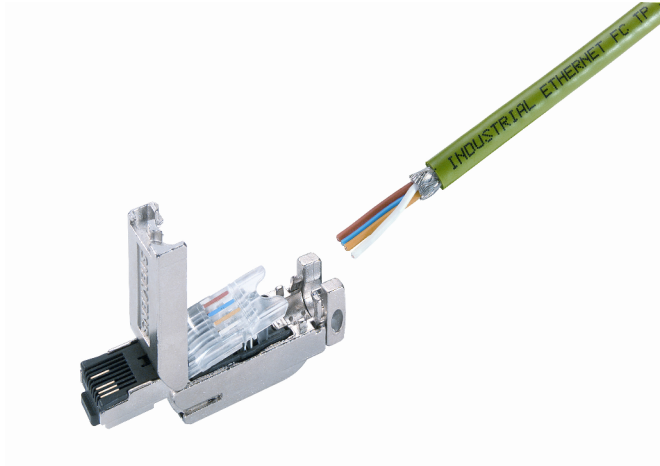

Figure 6-1 IE FC 45 Plug 180

### Plugging in the IE FC RJ45 Plug 180

Plug the IE FC RJ45 Plug 180 into the twisted-pair port of the device until it locks in place.



Figure 6-2 Plugging in the IE FC RJ45 Plug 180

When using Ethernet cables with IE FastConnect RJ-45 plugs on devices without securing collars, the cables must be supported on a cable guide close to the device.

### Pulling the IE FC RJ45 Plug 180

Press on the locking lever of the IE FC RJ45 Plug 180 gently to remove the plug.

If there is not enough space to release the lock with your hand, you can also use a 2.5 mm screwdriver. You can then remove the IE FC RJ45 Plug 180 from the RJ-45 jack.



 <b>WARNING</b>
<b>Unauthorized repair of devices in explosion-proof design</b> Risk of explosion in hazardous areas <ul style="list-style-type: none"><li>• Repair work may only be performed by personnel authorized by Siemens.</li></ul>

 <b>WARNING</b>
<b>Impermissible accessories and spare parts</b> Risk of explosion in hazardous areas <ul style="list-style-type: none"><li>• Only use original accessories and original spare parts.</li><li>• Observe all relevant installation and safety instructions described in the manuals for the device or supplied with the accessories or spare parts.</li></ul>



 <b>CAUTION</b>
<b>Hot surfaces</b> Risk of burns during maintenance work on parts with a surface temperature above 70 °C (158 °F). <ul style="list-style-type: none"><li>• Take appropriate protective measures, for example, wear protective gloves.</li><li>• Once maintenance work is complete, restore the touch protection measures.</li></ul>

<b>NOTICE</b>
<b>Cleaning the housing</b> If the device is not in a hazardous area, only clean the outer parts of the housing with a dry cloth. If the device is in a hazardous area, use a slightly damp cloth for cleaning. Do not use solvents.

## Fuses

The IE switches of the SCALANCE XB-000 product line have a resettable fuse / PTC. If the fuse triggers (all LEDs are off despite correctly applied power supply), the device should be disconnected from the power supply for approximately 30 minutes before turning it on again.

### **LED display when voltage is too low**

If the power supply is too low, then the internal power supply will switch off causing the Power LED and all port LEDs to go off. The functionality of the SCALANCE XB-000 is no longer available. A power supply of at least 19.2 V is necessary for correct operation.

### **Device defective**

If a fault develops, please send the device to your SIEMENS service center for repair. Repairs on-site are not possible.



# Technical specifications

## 8.1 SCALANCE XB004-1

Table 8-1 Technical specifications of the SCALANCE XB004-1

Technical specifications		
<b>Article number</b>		
SCALANCE XB004-1	6GK5 004-1BD00-1AB2	
<b>Attachment to Industrial Ethernet</b>		
Quantity	4	
Design	RJ-45 jacks with MDI-X pinning	
Properties	Half / full duplex	
Transmission rate	10/100 Mbps	
<b>Optical connectors</b>		
Quantity	1	
Design	SC socket	
Properties	Full duplex acc. to 100Base-FX	
Transmission rate	100 Mbps	
<b>Permitted cable lengths (Industrial Ethernet)</b>		
	<b>Alternative combinations per length range</b>	
0 to 55 m	<ul style="list-style-type: none"> <li>Max. 55 m IE TP Torsion Cable with IE FC RJ45 Plug 180</li> <li>Max. 45 m IE TP Torsion Cable with IE FC RJ45 + 10 m TP Cord via IE FC RJ45 Outlet</li> </ul>	
0 to 85 m	<ul style="list-style-type: none"> <li>Max. 85 m IE FC TP Marine/Trailing Cable with IE FC RJ45 Plug 180</li> <li>Max. 75 m IE FC TP Marine/Trailing Cable + 10 m TP Cord via IE FC RJ45 Outlet</li> </ul>	
0 to 100 m	<ul style="list-style-type: none"> <li>Max. 100 m IE FC TP Standard Cable with IE FC RJ45 Plug 180</li> <li>Max. 90 m IE FC TP Standard Cable + 10 m TP Cord via IE FC RJ45 Outlet</li> </ul>	
<b>Optical parameters</b>		
Cable type	Multimode glass FO cable, cable cross sections 62.5/125 µm and 50/125 µm	
Permitted cable length (glass FO cable)	Cable cross-section	Permitted cable length
	• 62.5/125 µm	• 0 to 4,000 m
	• 50/125 µm	• 0 to 5,000 m
<b>Electrical data</b>		
Power supply	Rated voltage	24 V AC, 50/60 Hz <sup>1)</sup>
		24 V DC
	Voltage range	19.2 to 28.8 V AC/DC Safety Extra Low Voltage (SELV)
	Design	3-terminal plug-in block
Current consumption	Typically 24 V AC	230 mA
	Typically 24 V DC	105 mA

<b>Technical specifications</b>		
Effective power loss	Typically 24 V AC	5.5 VA
	Typically 24 V DC	2.5 W
Overvoltage protection at input	PTC resettable fuse (0.5 A / 60 V)	
<b>Permitted ambient conditions</b>		
Ambient temperature	During operation	-10 °C to +60 °C
	During storage	-40 °C to +80 °C
	During transportation	-40 °C to +80 °C
Relative humidity	During operation	≤ 95 % no condensation
Operating altitude	During operation	≤ 2,000 m above sea level at max. +60 °C ambient temperature
		< 3,000 m above sea level at max. +55 °C ambient temperature
		< 4,000 m above sea level at max. +50 °C ambient temperature
<b>Design, dimensions and weight</b>		
Immunity	EN 61000-6-2	
Emission	EN 61000-6-4	
Degree of protection	IP20	
MTBF (EN/IEC 61709; 40 °C)	134 years	
Housing material	Polycarbonate (plastic)	
Weight	165 g	
Dimensions (W x H x D)	45 x 100 x 87 mm	
Installation options	<ul style="list-style-type: none"> <li>• Mounting on a DIN rail</li> <li>• Wall mounting</li> </ul>	
<b>Switching properties</b>		
Aging time	300 seconds / 45 seconds <sup>1)</sup>	
Max. number of learnable MAC addresses	1024	
Response to LLDP frames	Blocking	
Response to spanning tree BPDU frames	Forwarding	
CoS acc. to IEEE 802.1Q	Yes	
QoS priority queues	2 / 4 <sup>1)</sup>	
IEEE 802.1Q tags (VLAN ID, priority) transparent forwarding	Yes	
Maximum frame size	1536 bytes	
Forwarding of PRP frames (Parallel Redundancy Protocol)	Yes	

<sup>1)</sup> as of hardware version 4

**Note**

The number of IE switches of the SCALANCE XB-000 product line connected in a line influences the frame delay.

When a frame passes through IE switches of the SCALANCE XB-000 product line, it is delayed by the store and forward function of the switch

- with a 64 byte frame length by approx. 10 microseconds (at 100 Mbps)
- with a 1500 byte frame length by approx. 130 microseconds (at 100 Mbps)

This means the more devices of the SCALANCE XB-000 product line that the frame passes through, the longer the frame propagation time.

**Hardware version**

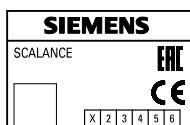

You will find the hardware version of your device on the type plate. On the type plate, the hardware version is printed as a placeholder "X".

Example: X 2 3 4 5 6

In this case, "X" would be the placeholder for hardware version 1.

## 8.2 SCALANCE XB004-2

Table 8-2 Technical specifications of the SCALANCE XB004-2

Technical specifications	
<b>Article number</b>	
SCALANCE XB004-2	6GK5 004-2BD00-1AB2
<b>Attachment to Industrial Ethernet</b>	
Quantity	4
Design	RJ-45 jacks with MDI-X pinning
Properties	Half / full duplex
Transmission rate	10/100 Mbps
<b>Optical connectors</b>	
Quantity	2
Design	SC socket
Properties	Full duplex acc. to 100Base-FX
Transmission rate	100 Mbps
<b>Permitted cable lengths (Industrial Ethernet)</b>	<b>Alternative combinations per length range</b>
0 to 55 m	<ul style="list-style-type: none"> <li>• Max. 55 m IE TP Torsion Cable with IE FC RJ45 Plug 180</li> <li>• Max. 45 m IE TP Torsion Cable with IE FC RJ45 + 10 m TP Cord via IE FC RJ45 Outlet</li> </ul>
0 to 85 m	<ul style="list-style-type: none"> <li>• Max. 85 m IE FC TP Marine/Trailing Cable with IE FC RJ45 Plug 180</li> <li>• Max. 75 m IE FC TP Marine/Trailing Cable + 10 m TP Cord via IE FC RJ45 Outlet</li> </ul>

<b>Technical specifications</b>		
0 to 100 m	<ul style="list-style-type: none"> <li>• Max. 100 m IE FC TP Standard Cable with IE FC RJ45 Plug 180</li> <li>• Max. 90 m IE FC TP Standard Cable + 10 m TP Cord via IE FC RJ45 Outlet</li> </ul>	
<b>Optical parameters</b>		
Cable type	Multimode glass FO cable, cable cross sections 62.5/125 µm and 50/125 µm	
Permitted cable length (glass FO cable)	Cable cross-section	Permitted cable length
	<ul style="list-style-type: none"> <li>• 62.5/125 µm</li> <li>• 50/125 µm</li> </ul>	<ul style="list-style-type: none"> <li>• 0 to 4,000 m</li> <li>• 0 to 5,000 m</li> </ul>
<b>Electrical data</b>		
Power supply	Rated voltage	24 V DC
	Voltage range	19.2 to 28.8 V DC Safe Extra Low Voltage (SELV)
	Design	3-terminal plug-in block
Current consumption	Typically 24 V DC	165 mA
Effective power loss	Typically 24 V DC	4 W
Overvoltage protection at input	PTC resettable fuse (0.5 A / 60 V)	
<b>Permitted ambient conditions</b>		
Ambient temperature	During operation	-10 °C to +60 °C
	During storage	-40 °C to +80 °C
	During transportation	-40 °C to +80 °C
Relative humidity	During operation	≤ 95 % no condensation
Operating altitude	During operation	≤ 2,000 m above sea level at max. +60 °C ambient temperature
		< 3,000 m above sea level at max. +55 °C ambient temperature
		< 4,000 m above sea level at max. +50 °C ambient temperature
<b>Design, dimensions and weight</b>		
Immunity	EN 61000-6-2	
Emission	EN 61000-6-4	
Degree of protection	IP20	
MTBF (EN/IEC 61709; 40 °C)	95 years	
Housing material	Polycarbonate (plastic)	
Weight	205 g	
Dimensions (W x H x D)	45 x 100 x 87 mm	
Installation options	<ul style="list-style-type: none"> <li>• Mounting on a DIN rail</li> <li>• Wall mounting</li> </ul>	
<b>Switching properties</b>		
Aging time	45 seconds	
Max. number of learnable MAC addresses	1024	
Response to LLDP frames	Blocking	
Response to spanning tree BPDU frames	Forwarding	

Technical specifications	
CoS acc. to IEEE 802.1Q	Yes
QoS priority queues	4
IEEE 802.1Q tags (VLAN ID, priority) transparent forwarding	Yes
Maximum frame size	1536 bytes
Forwarding of PRP frames (Parallel Redundancy Protocol)	Yes

#### Note

The number of IE switches of the SCALANCE XB-000 product line connected in a line influences the frame delay.

When a frame passes through IE switches of the SCALANCE XB-000 product line, it is delayed by the store and forward function of the switch

- with a 64 byte frame length by approx. 10 microseconds (at 100 Mbps)
- with a 1500 byte frame length by approx. 130 microseconds (at 100 Mbps)

This means the more devices of the SCALANCE XB-000 product line that the frame passes through, the longer the frame propagation time.

## 8.3 SCALANCE XB004-1LD

Table 8-3 Technical specifications of the SCALANCE XB004-1LD

Technical specifications	
<b>Article number</b>	
SCALANCE XB004-1LD	6GK5 004-1BF00-1AB2
<b>Attachment to Industrial Ethernet</b>	
Quantity	4
Design	RJ-45 jacks with MDI-X pinning
Properties	Half / full duplex
Transmission rate	10/100 Mbps
<b>Optical connectors</b>	
Quantity	1
Design	SC sockets
Properties	Full duplex acc. to 100Base-LX
Transmission rate	100 Mbps
<b>Permitted cable lengths (Industrial Ethernet)</b>	<b>Alternative combinations per length range</b>
0 to 55 m	<ul style="list-style-type: none"> <li>• Max. 55 m IE TP Torsion Cable with IE FC RJ45 Plug 180</li> <li>• Max. 45 m IE TP Torsion Cable with IE FC RJ45 + 10 m TP Cord via IE FC RJ45 Outlet</li> </ul>

<b>Technical specifications</b>		
0 to 85 m	<ul style="list-style-type: none"> <li>Max. 85 m IE FC TP Marine/Trailing Cable with IE FC RJ45 Plug 180</li> <li>Max. 75 m IE FC TP Marine/Trailing Cable + 10 m TP Cord via IE FC RJ45 Outlet</li> </ul>	
0 to 100 m	<ul style="list-style-type: none"> <li>Max. 100 m IE FC TP Standard Cable with IE FC RJ45 Plug 180</li> <li>Max. 90 m IE FC TP Standard Cable + 10 m TP Cord via IE FC RJ45 Outlet</li> </ul>	
<b>Optical parameters</b>		
Cable type	Single mode glass FO cable	
Cable cross-section	9/125 µm	
Permitted cable length	0 to 26,000 m	
Attenuation	≤ 0.5 dB/km at 1310 nm 14 dB max. permitted FO cable attenuation with 2 dB link power margin	
<b>Electrical data</b>		
Power supply	Rated voltage	24 V AC, 50/60 Hz <sup>1)</sup>
		24 V DC
	Voltage range	19.2 to 28.8 V AC/DC Safety Extra Low Voltage (SELV)
	Design	3-terminal plug-in block
Current consumption	Typically 24 V AC	210 mA
	Typically 24 V DC	95 mA
Effective power loss	Typically 24 V AC	5.1 VA
	Typically 24 V DC	2.3 W
Overvoltage protection at input	PTC resettable fuse (0.5 A / 60 V)	
<b>Permitted ambient conditions</b>		
Ambient temperature	During operation	-10 °C to +60 °C
	During storage	-40 °C to +80 °C
	During transportation	-40 °C to +80 °C
Relative humidity	During operation	≤ 95 % no condensation
Operating altitude	During operation	≤ 2,000 m above sea level at max. +60 °C ambient temperature
		< 3,000 m above sea level at max. +55 °C ambient temperature
		< 4,000 m above sea level at max. +50 °C ambient temperature
<b>Design, dimensions and weight</b>		
Immunity	EN 61000-6-2	
Emission	EN 61000-6-4	
Degree of protection	IP20	
MTBF (EN/IEC 61709; 40 °C)	130 years	
Housing material	Polycarbonate (plastic)	
Weight	165 g	
Dimensions (W x H x D)	45 x 100 x 87 mm	

### Technical specifications

Installation options	<ul style="list-style-type: none"> <li>• Mounting on a DIN rail</li> <li>• Wall mounting</li> </ul>
----------------------	---

### Switching properties

Aging time	300 seconds / 45 seconds <sup>1)</sup>
Max. number of learnable MAC addresses	1024
Response to LLDP frames	Blocking
Response to spanning tree BPDU frames	Forwarding
CoS acc. to IEEE 802.1Q	Yes
QoS priority queues	2 / 4 <sup>1)</sup>
IEEE 802.1Q tags (VLAN ID, priority) transparent forwarding	Yes
Maximum frame size	1536 bytes
Forwarding of PRP frames (Parallel Redundancy Protocol)	Yes

<sup>1)</sup> as of hardware version 4

### Note

The number of IE switches of the SCALANCE XB-000 product line connected in a line influences the frame delay.

When a frame passes through IE switches of the SCALANCE XB-000 product line, it is delayed by the store and forward function of the switch

- with a 64 byte frame length by approx. 10 microseconds (at 100 Mbps)
- with a 1500 byte frame length by approx. 130 microseconds (at 100 Mbps)

This means the more devices of the SCALANCE XB-000 product line that the frame passes through, the longer the frame propagation time.

### Hardware version

You will find the hardware version of your device on the type plate. On the type plate, the hardware version is printed as a placeholder "X".

Example: X 2 3 4 5 6

In this case, "X" would be the placeholder for hardware version 1.

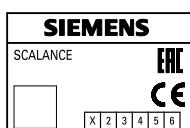

## 8.4 SCALANCE XB004-2LD

### Hardware version

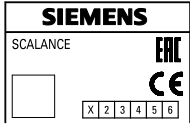

You will find the hardware version of your device on the type plate. On the type plate, the hardware version is printed as a placeholder "X".

Example: X 2 3 4 5 6

In this case, "X" would be the placeholder for hardware version 1.

Table 8-4 Technical specifications of the SCALANCE XB004-2LD

Technical specifications		
<b>Article number</b>		
SCALANCE XB004-2LD	6GK5 004-2BF00-1AB2	
<b>Connection to Industrial Ethernet</b>		
Quantity	4	
Design	RJ-45 jacks with MDI-X pinning	
Properties	Half / full duplex	
Transmission rate	10/100 Mbps	
<b>Optical connectors</b>		
Quantity	2	
Design	SC sockets	
Properties	Full duplex acc. to 100Base-LX	
Transmission rate	100 Mbps	
<b>Permitted cable lengths (Industrial Ethernet)</b>	<b>Alternative combinations per length range</b>	
0 to 55 m	<ul style="list-style-type: none"> <li>Max. 55 m IE TP Torsion Cable with IE FC RJ45 Plug 180</li> <li>Max. 45 m IE TP Torsion Cable with IE FC RJ45 + 10 m TP Cord via IE FC RJ45 Outlet</li> </ul>	
0 to 85 m	<ul style="list-style-type: none"> <li>Max. 85 m IE FC TP Marine/Trailing Cable with IE FC RJ45 Plug 180</li> <li>Max. 75 m IE FC TP Marine/Trailing Cable + 10 m TP Cord via IE FC RJ45 Outlet</li> </ul>	
0 to 100 m	<ul style="list-style-type: none"> <li>Max. 100 m IE FC TP Standard Cable with IE FC RJ45 Plug 180</li> <li>Max. 90 m IE FC TP Standard Cable + 10 m TP Cord via IE FC RJ45 Outlet</li> </ul>	
<b>Optical parameters</b>		
Cable type	Single mode glass FO cable	
Cable cross-section	9/125 µm	
Permitted cable length	0 to 26,000 m	
Attenuation	≤ 0.5 dB/km at 1310 nm 14 dB max. permitted FO cable attenuation with 2 dB link power margin	
<b>Electrical data</b>		
Power supply	Rated voltage	24 V DC
	Voltage range	19.2 to 28.8 V DC Safe Extra Low Voltage (SELV)
	Design	3-terminal plug-in block



<b>Technical specifications</b>		
Current consumption	Typically 24 V DC	165 mA
Effective power loss	Typically 24 V DC	4 W
Overvoltage protection at input		PTC resettable fuse (0.5 A / 60 V)
<b>Permitted ambient conditions</b>		
Ambient temperature	During operation	-10 °C to +60 °C
	During storage	-40 °C to +80 °C
	During transportation	-40 °C to +80 °C
Relative humidity	During operation	≤ 95% without condensation
Operating altitude	During operation	≤ 2,000 m above sea level at max. +60 °C ambient temperature
		< 3,000 m above sea level at max. +55 °C ambient temperature
		< 4,000 m above sea level at max. +50 °C ambient temperature
<b>Design, dimensions and weight</b>		
Immunity	EN 61000-6-2	
Emission	EN 61000-6-4	
Degree of protection	IP20	
MTBF (EN/IEC 61709; 40 °C)	95 years	
Housing material	Polycarbonate (plastic)	
Weight	205 g	
Dimensions (W x H x D)	45 x 100 x 87 mm	
Installation options	<ul style="list-style-type: none"> <li>• Mounting on a DIN rail</li> <li>• Wall mounting</li> </ul>	
<b>Switching properties</b>		
Aging time	300 seconds / 45 seconds <sup>1)</sup>	
Max. number of learnable MAC addresses	1024	
Response to LLDP frames	Blocking	
Response to spanning tree BPDU frames	Forwarding	
CoS acc. to IEEE 802.1Q	Yes	
QoS priority queues	2 / 4 <sup>1)</sup>	
IEEE 802.1Q tags (VLAN ID, priority) transparent forwarding	Yes	
Maximum frame size	1536 bytes	
Forwarding of PRP frames (Parallel Redundancy Protocol)	Yes	

8.5 SCALANCE XB005

<sup>1)</sup> as of hardware version 4

**Note**

The number of IE switches of the SCALANCE XB-000 product line connected in a line influences the frame delay.

When a frame passes through IE switches of the SCALANCE XB-000 product line, it is delayed by the store and forward function of the switch

- with a 64 byte frame length by approx. 10 microseconds (at 100 Mbps)
- with a 1500 byte frame length by approx. 130 microseconds (at 100 Mbps)

This means the more devices of the SCALANCE XB-000 product line that the frame passes through, the longer the frame propagation time.

## 8.5 SCALANCE XB005

Table 8-5 Technical specifications of the SCALANCE XB005

Technical specifications		
Article number		
SCALANCE XB005	6GK5 005-0BA00-1AB2	
Attachment to Industrial Ethernet		
Quantity	5	
Design	RJ-45 jacks with MDI-X pinning	
Properties	Half / full duplex	
Transmission rate	10/100 Mbps	
Permitted cable lengths (Industrial Ethernet)	Alternative combinations per length range	
0 to 55 m	<ul style="list-style-type: none"> <li>• Max. 55 m IE TP Torsion Cable with IE FC RJ45 Plug 180</li> <li>• Max. 45 m IE TP Torsion Cable with IE FC RJ45 + 10 m TP Cord via IE FC RJ45 Outlet</li> </ul>	
0 to 85 m	<ul style="list-style-type: none"> <li>• Max. 85 m IE FC TP Marine/Trailing Cable with IE FC RJ45 Plug 180</li> <li>• Max. 75 m IE FC TP Marine/Trailing Cable + 10 m TP Cord via IE FC RJ45 Outlet</li> </ul>	
0 to 100 m	<ul style="list-style-type: none"> <li>• Max. 100 m IE FC TP Standard Cable with IE FC RJ45 Plug 180</li> <li>• Max. 90 m IE FC TP Standard Cable + 10 m TP Cord via IE FC RJ45 Outlet</li> </ul>	
Electrical data		
Power supply	Rated voltage	24 V AC, 50/60 Hz <sup>1)</sup>
		24 V DC
	Voltage range	19.2 to 28.8 V AC/DC Safety Extra Low Voltage (SELV)
	Design	3-terminal plug-in block
Current consumption	Typically 24 V AC	150 mA
	Typically 24 V DC	65 mA

<b>Technical specifications</b>		
Effective power loss	Typically 24 V AC	3.6 VA
	Typically 24 V DC	1.6 W
Overvoltage protection at input	PTC resettable fuse (0.5 A / 60 V)	
<b>Permitted ambient conditions</b>		
Ambient temperature	During operation	-10 °C to +60 °C
	During storage	-40 °C to +80 °C
	During transportation	-40 °C to +80 °C
Relative humidity	During operation	≤ 95 % no condensation
Operating altitude	During operation	≤ 2,000 m above sea level at max. +60 °C ambient temperature
		< 3,000 m above sea level at max. +55 °C ambient temperature
		< 4,000 m above sea level at max. +50 °C ambient temperature
<b>Design, dimensions and weight</b>		
Immunity	EN 61000-6-2	
Emission	EN 61000-6-4	
Degree of protection	IP20	
MTBF (EN/IEC 61709; 40 °C)	175 years	
Housing material	Polycarbonate (plastic)	
Weight	165 g	
Dimensions (W x H x D)	45 x 100 x 87 mm	
Installation options	<ul style="list-style-type: none"> <li>• Mounting on a DIN rail</li> <li>• Wall mounting</li> </ul>	
<b>Switching properties</b>		
Aging time	300 seconds / 45 seconds <sup>1)</sup>	
Max. number of learnable MAC addresses	1024	
Response to LLDP frames	Blocking	
Response to spanning tree BPDU frames	Forwarding	
CoS acc. to IEEE 802.1Q	Yes	
QoS priority queues	2 / 4 <sup>1)</sup>	
IEEE 802.1Q tags (VLAN ID, priority) transparent forwarding	Yes	
Maximum frame size	1536 bytes	
Forwarding of PRP frames (Parallel Redundancy Protocol)	Yes	

8.6 SCALANCE XB008

<sup>1)</sup> as of hardware version 5

**Note**

The number of IE switches of the SCALANCE XB-000 product line connected in a line influences the frame delay.

When a frame passes through IE switches of the SCALANCE XB-000 product line, it is delayed by the store and forward function of the switch

- with a 64 byte frame length by approx. 10 microseconds (at 100 Mbps)
- with a 1500 byte frame length by approx. 130 microseconds (at 100 Mbps)

This means the more devices of the SCALANCE XB-000 product line that the frame passes through, the longer the frame propagation time.

**Hardware version**

You will find the hardware version of your device on the type plate. On the type plate, the hardware version is printed as a placeholder "X".

Example: X 2 3 4 5 6

In this case, "X" would be the placeholder for hardware version 1.

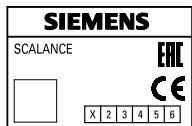

**8.6 SCALANCE XB008**

**Note**

Note the article number in the technical specifications.

Table 8-6 Technical specifications of the SCALANCE XB008 (6GK5 008-0BA00-1AB2)

Technical specifications	
<b>Article number</b>	
SCALANCE XB008	6GK5 008-0BA00-1AB2
<b>Attachment to Industrial Ethernet</b>	
Quantity	8
Design	RJ-45 jacks with MDI-X pinning
Properties	Half / full duplex
Transmission rate	10/100 Mbps
<b>Permitted cable lengths (Industrial Ethernet)</b>	<b>Alternative combinations per length range</b>
0 to 55 m	<ul style="list-style-type: none"> <li>• Max. 55 m IE TP Torsion Cable with IE FC RJ45 Plug 180</li> <li>• Max. 45 m IE TP Torsion Cable with IE FC RJ45 + 10 m TP Cord via IE FC RJ45 Outlet</li> </ul>
0 to 85 m	<ul style="list-style-type: none"> <li>• Max. 85 m IE FC TP Marine/Trailing Cable with IE FC RJ45 Plug 180</li> <li>• Max. 75 m IE FC TP Marine/Trailing Cable + 10 m TP Cord via IE FC RJ45 Outlet</li> </ul>

<b>Technical specifications</b>		
0 to 100 m		<ul style="list-style-type: none"> <li>• Max. 100 m IE FC TP Standard Cable with IE FC RJ45 Plug 180</li> <li>• Max. 90 m IE FC TP Standard Cable + 10 m TP Cord via IE FC RJ45 Outlet</li> </ul>
<b>Electrical data</b>		
Power supply	Rated voltage	24 V DC
	Voltage range	19.2 to 28.8 V DC Safe Extra Low Voltage (SELV)
	Design	3-terminal plug-in block
Current consumption	Typical	150 mA
Power loss at 24 V DC	Typical	3.40 W
Overvoltage protection at input		PTC resettable fuse (0.6 A / 60 V)
<b>Permitted ambient conditions</b>		
Ambient temperature	During operation	-10 °C to +60 °C
	During storage	-40 °C to +80 °C
	During transportation	-40 °C to +80 °C
Relative humidity	During operation	≤ 95 % no condensation
Operating altitude	During operation	≤ 2,000 m above sea level at max. +60 °C ambient temperature
		< 3,000 m above sea level at max. +55 °C ambient temperature
		< 4,000 m above sea level at max. +50 °C ambient temperature
<b>Design, dimensions and weight</b>		
Immunity	EN 61000-6-2	
Emission	EN 61000-6-4	
Degree of protection	IP20	
MTBF (EN/IEC 61709; 40 °C)	214 years	
Housing material	Polycarbonate (plastic)	
Weight	180 g	
Dimensions (W x H x D)	45 x 100 x 87 mm	
Installation options	<ul style="list-style-type: none"> <li>• Mounting on a DIN rail</li> <li>• Wall mounting</li> </ul>	
<b>Switching properties</b>		
Aging time	300 seconds	
Max. number of learnable MAC addresses	1024	
Response to LLDP frames	Blocking	
Response to spanning tree BPDU frames	Forwarding	
CoS acc. to IEEE 802.1Q	Yes	
QoS priority queues	2	
IEEE 802.1Q tags (VLAN ID, priority) transparent forwarding	Yes	

8.6 SCALANCE XB008

Technical specifications	
Maximum frame size	1536 bytes
Forwarding of PRP frames (Parallel Redundancy Protocol)	Yes
<b>Note</b>	
The number of IE switches of the SCALANCE XB-000 product line connected in a line influences the frame delay.	
When a frame passes through IE switches of the SCALANCE XB-000 product line, it is delayed by the store and forward function of the switch	
<ul style="list-style-type: none"> <li>with a 64 byte frame length by approx. 10 microseconds (at 100 Mbps)</li> <li>with a 1500 byte frame length by approx. 130 microseconds (at 100 Mbps)</li> </ul>	
This means the more devices of the SCALANCE XB-000 product line that the frame passes through, the longer the frame propagation time.	

Table 8-7 Technical specifications of the SCALANCE XB008 (6GK5 008-0BA10-1AB2)

Technical specifications		
Article number		
SCALANCE XB008	6GK5 008-0BA10-1AB2	
Attachment to Industrial Ethernet		
Quantity	8	
Design	RJ-45 jacks with MDI-X pinning	
Properties	Half / full duplex	
Transmission rate	10/100 Mbps	
Permitted cable lengths (Industrial Ethernet)	Alternative combinations per length range	
0 to 55 m	<ul style="list-style-type: none"> <li>Max. 55 m IE TP Torsion Cable with IE FC RJ45 Plug 180</li> <li>Max. 45 m IE TP Torsion Cable with IE FC RJ45 + 10 m TP Cord via IE FC RJ45 Outlet</li> </ul>	
0 to 85 m	<ul style="list-style-type: none"> <li>Max. 85 m IE FC TP Marine/Trailing Cable with IE FC RJ45 Plug 180</li> <li>Max. 75 m IE FC TP Marine/Trailing Cable + 10 m TP Cord via IE FC RJ45 Outlet</li> </ul>	
0 to 100 m	<ul style="list-style-type: none"> <li>Max. 100 m IE FC TP Standard Cable with IE FC RJ45 Plug 180</li> <li>Max. 90 m IE FC TP Standard Cable + 10 m TP Cord via IE FC RJ45 Outlet</li> </ul>	
Electrical data		
Power supply	Rated voltage	24 V AC, 50/60 Hz
		24 V DC
	Voltage range	19.2 to 28.8 V AC/DC Safety Extra Low Voltage (SELV)
	Design	3-terminal plug-in block
Current consumption	Typically 24 V AC	140 mA
	Typically 24 V DC	75 mA
Effective power loss	Typically 24 V AC	3.36 W
	Typically 24 V DC	1.80 W

<b>Technical specifications</b>		
Overvoltage protection at input		PTC resettable fuse (0.6 A / 60 V)
<b>Permitted ambient conditions</b>		
Ambient temperature	During operation	-10 °C to +60 °C
	During storage	-40 °C to +80 °C
	During transportation	-40 °C to +80 °C
Relative humidity	During operation	≤ 95 % no condensation
Operating altitude	During operation	≤ 2,000 m above sea level at max. +60 °C ambient temperature
		< 3,000 m above sea level at max. +55 °C ambient temperature
		< 4,000 m above sea level at max. +50 °C ambient temperature
<b>Design, dimensions and weight</b>		
Immunity	EN 61000-6-2	
Emission	EN 61000-6-4	
Degree of protection	IP20	
MTBF (EN/IEC 61709; 40 °C)	214 years	
Housing material	Polycarbonate (plastic)	
Weight	180 g	
Dimensions (W x H x D)	45 x 100 x 87 mm	
Installation options	<ul style="list-style-type: none"> <li>• Mounting on a DIN rail</li> <li>• Wall mounting</li> </ul>	
<b>Switching properties</b>		
Aging time	45 seconds	
Max. number of learnable MAC addresses	1024	
Response to LLDP frames	Blocking	
Response to spanning tree BPDU frames	Forwarding	
CoS acc. to IEEE 802.1Q	Yes	
QoS priority queues	4	
IEEE 802.1Q tags (VLAN ID, priority) transparent forwarding	Yes	
Maximum frame size	1536 bytes	
Forwarding of PRP frames (Parallel Redundancy Protocol)	Yes	

8.7 SCALANCE XB004-1G

**Note**

The number of IE switches of the SCALANCE XB-000 product line connected in a line influences the frame delay.

When a frame passes through IE switches of the SCALANCE XB-000 product line, it is delayed by the store and forward function of the switch

- with a 64 byte frame length by approx. 10 microseconds (at 100 Mbps)
- with a 1500 byte frame length by approx. 130 microseconds (at 100 Mbps)

This means the more devices of the SCALANCE XB-000 product line that the frame passes through, the longer the frame propagation time.

## 8.7 SCALANCE XB004-1G

**Note**

Note the article number in the technical specifications.

Table 8-8 Technical specifications of the SCALANCE XB004-1G (6GK5 004-1GL00-1AB2)

<b>Technical specifications</b>	
<b>Article number</b>	
SCALANCE XB004-1G	6GK5 004-1GL00-1AB2
<b>Attachment to Industrial Ethernet</b>	
Quantity	4
Design	RJ-45 jacks with MDI-X pinning
Properties	Half / full duplex
Transmission rate	10 / 100 / 1000 Mbps
<b>Optical connectors</b>	
Quantity	1
Design	SC socket
Properties	Full duplex acc. to 1000Base-SX
Transmission rate	1000 Mbps
<b>Permitted cable lengths (Industrial Ethernet)</b>	<b>Alternative combinations per length range</b>
0 to 55 m	<ul style="list-style-type: none"> <li>• Max. 55 m IE TP Torsion Cable 4x2 with IE FC RJ45 Plug 180 4x2</li> <li>• Max. 45 m IE TP Torsion Cable 4x2 with IE FC RJ45 + 10 m TP Cord 4x2 via IE FC RJ45 Outlet</li> </ul>
0 to 85 m	<ul style="list-style-type: none"> <li>• Max. 85 m IE FC TP Marine/Trailing Cable 4x2 with IE FC RJ45 Plug 180 4x2</li> <li>• Max. 75 m IE FC TP Marine/Trailing Cable 4x2 + 10 m TP Cord 4x2 via IE FC RJ45 Outlet</li> </ul>



Technical specifications		
0 to 100 m		<ul style="list-style-type: none"> <li>Max. 100 m IE FC TP Standard Cable 4x2 with IE FC RJ45 Plug 180 4x2</li> <li>Max. 90 m IE FC TP Standard Cable 4x2 + 10 m TP Cord 4x2 via IE FC RJ45 Outlet</li> </ul>
Optical parameters		
Cable type	Multimode glass FO cable	
Cable cross-section	50/125 µm	
Permitted cable length	0 to 750 m	
Electrical data		
Power supply	Rated voltage	24 V DC
	Voltage range	19.2 to 28.8 V DC Safe Extra Low Voltage (SELV)
	Design	3-terminal plug-in block
Current consumption	Typical	650 mA
Power loss at 24 V DC	Typical	15.6 W
Overvoltage category	CAT II	
Overvoltage protection at input	PTC resettable fuse (1.0 A / 60 V)	
Permitted ambient conditions		
Ambient temperature	During operation	-10 °C to +60 °C
	During storage	-40 °C to +80 °C
	During transportation	-40 °C to +80 °C
Relative humidity	During operation	≤ 95 % no condensation
Operating altitude	During operation	≤ 2,000 m above sea level at max. +60 °C ambient temperature
		< 3,000 m above sea level at max. +55 °C ambient temperature
		< 4,000 m above sea level at max. +50 °C ambient temperature
Design, dimensions and weight		
Immunity	EN 61000-6-2	
Emission	EN 61000-6-4	
Degree of protection	IP20	
MTBF (EN/IEC 61709; 40 °C)	146 years	
Housing material	Polycarbonate (plastic)	
Weight	210 g	
Dimensions (W x H x D)	45 x 100 x 87 mm	
Installation options	<ul style="list-style-type: none"> <li>Mounting on a DIN rail</li> <li>Wall mounting</li> </ul>	
Switching properties		
Aging time	300 seconds	
Max. number of learnable MAC addresses	8192	
Response to LLDP frames	Blocking	
Response to spanning tree BPDU frames	Forwarding	

8.7 SCALANCE XB004-1G

Technical specifications	
CoS acc. to IEEE 802.1Q	Yes
QoS priority queues	4
IEEE 802.1Q tags (VLAN ID, priority) transparent forwarding	Yes
Maximum frame size	1536 bytes
Forwarding of PRP frames (Parallel Redundancy Protocol)	Yes

**Note**

The number of IE switches of the SCALANCE XB-000 product line connected in a line influences the frame delay.

When a frame passes through IE switches of the SCALANCE XB-000 product line, it is delayed by the store and forward function of the switch

- with a 64 byte frame length by approx. 10 microseconds (at 100 Mbps)
- with a 1500 byte frame length by approx. 130 microseconds (at 100 Mbps)

This means the more devices of the SCALANCE XB-000 product line that the frame passes through, the longer the frame propagation time.

Table 8-9 Technical specifications of the SCALANCE XB004-1G (6GK5 004-1GL10-1AB2)

Technical specifications	
<b>Article number</b>	
SCALANCE XB004-1G	6GK5 004-1GL10-1AB2
<b>Attachment to Industrial Ethernet</b>	
Quantity	4
Design	RJ-45 jacks with MDI-X pinning
Properties	Half / full duplex
Transmission rate	10 / 100 / 1000 Mbps
<b>Optical connectors</b>	
Quantity	1
Design	SC socket
Properties	Full duplex acc. to 1000Base-SX
Transmission rate	1000 Mbps
<b>Permitted cable lengths (Industrial Ethernet)</b>	<b>Alternative combinations per length range</b>
0 to 55 m	<ul style="list-style-type: none"> <li>• Max. 55 m IE TP Torsion Cable 4x2 with IE FC RJ45 Plug 180 4x2</li> <li>• Max. 45 m IE TP Torsion Cable 4x2 with IE FC RJ45 + 10 m TP Cord 4x2 via IE FC RJ45 Outlet</li> </ul>
0 to 85 m	<ul style="list-style-type: none"> <li>• Max. 85 m IE FC TP Marine/Trailing Cable 4x2 with IE FC RJ45 Plug 180 4x2</li> <li>• Max. 75 m IE FC TP Marine/Trailing Cable 4x2 + 10 m TP Cord 4x2 via IE FC RJ45 Outlet</li> </ul>

Technical specifications		
0 to 100 m		<ul style="list-style-type: none"> <li>Max. 100 m IE FC TP Standard Cable 4x2 with IE FC RJ45 Plug 180 4x2</li> <li>Max. 90 m IE FC TP Standard Cable 4x2 + 10 m TP Cord 4x2 via IE FC RJ45 Outlet</li> </ul>
Optical parameters		
Cable type		Multimode glass FO cable
Cable cross-section		50/125 µm
Permitted cable length		0 to 750 m
Electrical data		
Power supply	Rated voltage	24 V DC
	Voltage range	19.2 to 28.8 V DC Safe Extra Low Voltage (SELV)
	Design	3-terminal plug-in block
Current consumption	Typical	155 mA
Power loss at 24 V DC	Typical	3.7 W
Overvoltage category		CAT II
Overvoltage protection at input		PTC resettable fuse (1.0 A / 60 V)
Permitted ambient conditions		
Ambient temperature	During operation	-10 °C to +60 °C
	During storage	-40 °C to +85 °C
	During transportation	-40 °C to +85 °C
Relative humidity	During operation	≤ 95 % no condensation
Operating altitude	During operation	≤ 2,000 m above sea level at max. +60 °C ambient temperature < 3,000 m above sea level at max. +55 °C ambient temperature < 4,000 m above sea level at max. +50 °C ambient temperature
Design, dimensions and weight		
Immunity		EN 61000-6-2
Emission		EN 61000-6-4
Degree of protection		IP20
MTBF (EN/IEC 61709; 40 °C)		148 years
Housing material		Polycarbonate (plastic)
Weight		210 g
Dimensions (W x H x D)		45 x 100 x 87 mm
Installation options		<ul style="list-style-type: none"> <li>Mounting on a DIN rail</li> <li>Wall mounting</li> </ul>
Switching properties		
Aging time		45 seconds
Max. number of learnable MAC addresses		16000
Response to LLDP frames		Blocking
Response to spanning tree BPDU frames		Forwarding

8.8 SCALANCE XB004-1LDG

Technical specifications	
CoS acc. to IEEE 802.1Q	Yes
QoS priority queues	8
IEEE 802.1Q tags (VLAN ID, priority) transparent forwarding	Yes
Maximum frame size	1536 bytes
Forwarding of PRP frames (Parallel Redundancy Protocol)	Yes

**Note**

The number of IE switches of the SCALANCE XB-000 product line connected in a line influences the frame delay.

When a frame passes through IE switches of the SCALANCE XB-000 product line, it is delayed by the store and forward function of the switch

- with a 64 byte frame length by approx. 10 microseconds (at 100 Mbps)
- with a 1500 byte frame length by approx. 130 microseconds (at 100 Mbps)

This means the more devices of the SCALANCE XB-000 product line that the frame passes through, the longer the frame propagation time.

## 8.8 SCALANCE XB004-1LDG

**Note**

Note the article number in the technical specifications.

Table 8-10 Technical specifications of the SCALANCE XB004-1LDG (6GK5 004-1GM00-1AB2)

Technical specifications	
<b>Article number</b>	
SCALANCE XB004-1LDG	6GK5 004-1GM00-1AB2
<b>Connection to Industrial Ethernet</b>	
Quantity	4
Design	RJ-45 jacks with MDI-X pinning
Properties	Half / full duplex
Transmission rate	10 / 100 / 1000 Mbps
<b>Optical connectors</b>	
Quantity	1
Design	SC sockets
Properties	Full duplex acc. to 1000Base-LH
Transmission rate	1000 Mbps

<b>Technical specifications</b>		
<b>Permitted cable lengths (Industrial Ethernet)</b>	<b>Alternative combinations per length range</b>	
0 to 55 m	<ul style="list-style-type: none"> <li>• Max. 55 m IE TP Torsion Cable 4x2 with IE FC RJ45 Plug 180 4x2</li> <li>• Max. 45 m IE TP Torsion Cable 4x2 with IE FC RJ45 + 10 m TP Cord 4x2 via IE FC RJ45 Outlet</li> </ul>	
0 to 85 m	<ul style="list-style-type: none"> <li>• Max. 85 m IE FC TP Marine/Trailing Cable 4x2 with IE FC RJ45 Plug 180 4x2</li> <li>• Max. 75 m IE FC TP Marine/Trailing Cable 4x2 + 10 m TP Cord 4x2 via IE FC RJ45 Outlet</li> </ul>	
0 to 100 m	<ul style="list-style-type: none"> <li>• Max. 100 m IE FC TP Standard Cable 4x2 with IE FC RJ45 Plug 180 4x2</li> <li>• Max. 90 m IE FC TP Standard Cable 4x2 + 10 m TP Cord 4x2 via IE FC RJ45 Outlet</li> </ul>	
<b>Optical parameters</b>		
Cable type	Single mode glass FO cable	
Cable cross-section	9/125 µm	
Permitted cable length	0 to 10,000 m	
Attenuation	≤ 0.5 dB/km at 1310 nm 13 dB max. permitted FO cable attenuation with 2 dB link power margin	
<b>Electrical data</b>		
Power supply	Rated voltage	24 V DC
	Voltage range	19.2 to 28.8 V DC Safe Extra Low Voltage (SELV)
	Design	3-terminal plug-in block
Current consumption	Typical	650 mA
Power loss at 24 V DC	Typical	15.6 W
Overvoltage category	CAT II	
Overvoltage protection at input	PTC resettable fuse (1.0 A / 60 V)	
<b>Permitted ambient conditions</b>		
Ambient temperature	During operation	-10 °C to +60 °C
	During storage	-40 °C to +80 °C
	During transportation	-40 °C to +80 °C
Relative humidity	During operation	≤ 95% without condensation
Operating altitude	During operation	≤ 2,000 m above sea level at max. +60 °C ambient temperature
		< 3,000 m above sea level at max. +55 °C ambient temperature
		< 4,000 m above sea level at max. +50 °C ambient temperature
<b>Design, dimensions and weight</b>		
Immunity	EN 61000-6-2	
Emission	EN 61000-6-4	
Degree of protection	IP20	
MTBF (EN/IEC 61709; 40 °C)	146 years	
Housing material	Polycarbonate (plastic)	

8.8 SCALANCE XB004-1LDG

Technical specifications	
Weight	210 g
Dimensions (W x H x D)	45 x 100 x 87 mm
Installation options	<ul style="list-style-type: none"> <li>• Mounting on a DIN rail</li> <li>• Wall mounting</li> </ul>
Switching properties	
Aging time	300 seconds
Max. number of learnable MAC addresses	8192
Response to LLDP frames	Blocking
Response to spanning tree BPDU frames	Forwarding
CoS acc. to IEEE 802.1Q	Yes
QoS priority queues	4
IEEE 802.1Q tags (VLAN ID, priority)	Yes
transparent forwarding	
Maximum frame size	1536 bytes
Forwarding of PRP frames (Parallel Redundancy Protocol)	Yes

**Note**

The number of IE switches of the SCALANCE XB-000 product line connected in a line influences the frame delay.

When a frame passes through IE switches of the SCALANCE XB-000 product line, it is delayed by the store and forward function of the switch

- with a 64 byte frame length by approx. 10 microseconds (at 100 Mbps)
- with a 1500 byte frame length by approx. 130 microseconds (at 100 Mbps)

This means the more devices of the SCALANCE XB-000 product line that the frame passes through, the longer the frame propagation time.

Table 8-11 Technical specifications of the SCALANCE XB004-1LDG (6GK5 004-1GM10-1AB2)

Technical specifications	
Article number	
SCALANCE XB004-1LDG	6GK5 004-1GM10-1AB2
Connection to Industrial Ethernet	
Number	4
Design	RJ-45 jacks with MDI-X pinning
Properties	Half / full duplex
Transmission rate	10 / 100 / 1000 Mbps
Optical connectors	
Number	1
Design	SC sockets

<b>Technical specifications</b>		
Properties	Full duplex acc. to 1000Base-LH	
Transmission rate	1000 Mbps	
<b>Permitted cable lengths (Industrial Ethernet)</b>	<b>Alternative combinations per length range</b>	
0 to 55 m	<ul style="list-style-type: none"> <li>• Max. 55 m IE TP Torsion Cable 4x2 with IE FC RJ45 Plug 180 4x2</li> <li>• Max. 45 m IE TP Torsion Cable 4x2 with IE FC RJ45 + 10 m TP Cord 4x2 via IE FC RJ45 Outlet</li> </ul>	
0 to 85 m	<ul style="list-style-type: none"> <li>• Max. 85 m IE FC TP Marine/Trailing Cable 4x2 with IE FC RJ45 Plug 180 4x2</li> <li>• Max. 75 m IE FC TP Marine/Trailing Cable 4x2 + 10 m TP Cord 4x2 via IE FC RJ45 Outlet</li> </ul>	
0 to 100 m	<ul style="list-style-type: none"> <li>• Max. 100 m IE FC TP Standard Cable 4x2 with IE FC RJ45 Plug 180 4x2</li> <li>• Max. 90 m IE FC TP Standard Cable 4x2 + 10 m TP Cord 4x2 via IE FC RJ45 Outlet</li> </ul>	
<b>Optical parameters</b>		
Cable type	Single mode glass FO cable	
Cable cross-section	9/125 µm	
Permitted cable length	0 to 10,000 m	
Attenuation	≤ 0.5 dB/km at 1310 nm 13 dB max. permitted FO cable attenuation with 2 dB link power margin	
<b>Electrical data</b>		
Power supply	Rated voltage	24 V DC
	Voltage range	19.2 to 28.8 V DC Safe Extra Low Voltage (SELV)
	Design	3-terminal plug-in block
Current consumption	Typical	155 mA
Power loss at 24 V DC	Typical	3.7 W
Overvoltage category	CAT II	
Overvoltage protection at input	PTC resettable fuse (1.0 A / 60 V)	
<b>Permitted ambient conditions</b>		
Ambient temperature	During operation	-10 °C to +60 °C
	During storage	-40 °C to +85 °C
	During transportation	-40 °C to +85 °C
Relative humidity	During operation	≤ 95% without condensation
Operating altitude	During operation	≤ 2,000 m above sea level at max. +60 °C ambient temperature
		< 3,000 m above sea level at max. +55 °C ambient temperature
		< 4,000 m above sea level at max. +50 °C ambient temperature
<b>Design, dimensions and weight</b>		
Immunity	EN 61000-6-2	
Emission	EN 61000-6-4	
Degree of protection	IP20	

8.9 SCALANCE XB005G

Technical specifications	
MTBF (EN/IEC 61709; 40 °C)	162 years
Housing material	Polycarbonate (plastic)
Weight	168 g
Dimensions (W x H x D)	45 x 100 x 87 mm
Installation options	<ul style="list-style-type: none"> <li>• Mounting on a DIN rail</li> <li>• Wall mounting</li> </ul>
Switching properties	
Aging time	45 seconds
Max. number of learnable MAC addresses	16000
Response to LLDP frames	Blocking
Response to spanning tree BPDU frames	Forwarding
CoS acc. to IEEE 802.1Q	Yes
QoS priority queues	8
IEEE 802.1Q tags (VLAN ID, priority) transparent forwarding	Yes
Maximum frame size	1536 bytes
Forwarding of PRP frames (Parallel Redundancy Protocol)	Yes

**Note**

The number of IE switches of the SCALANCE XB-000 product line connected in a line influences the frame delay.

When a frame passes through IE switches of the SCALANCE XB-000 product line, it is delayed by the store and forward function of the switch

- with a 64 byte frame length by approx. 10 microseconds (at 100 Mbps)
- with a 1500 byte frame length by approx. 130 microseconds (at 100 Mbps)

This means the more devices of the SCALANCE XB-000 product line that the frame passes through, the longer the frame propagation time.

## 8.9 SCALANCE XB005G

**Note**

Note the article number in the technical specifications.



Table 8-12 Technical specifications of the SCALANCE XB005G (6GK5 005-0GA00-1AB2)

<b>Technical specifications</b>		
<b>Article number</b>		
SCALANCE XB005G	6GK5 005-0GA00-1AB2	
<b>Attachment to Industrial Ethernet</b>		
Quantity	5	
Design	RJ-45 jacks with MDI-X pinning	
Properties	Half / full duplex	
Transmission rate	10 / 100 / 1000 Mbps	
<b>Permitted cable lengths (Industrial Ethernet)</b>	<b>Alternative combinations per length range</b>	
0 to 55 m	<ul style="list-style-type: none"> <li>Max. 55 m IE TP Torsion Cable 4x2 with IE FC RJ45 Plug 180 4x2</li> <li>Max. 45 m IE TP Torsion Cable 4x2 with IE FC RJ45 + 10 m TP Cord 4x2 via IE FC RJ45 Outlet</li> </ul>	
0 to 85 m	<ul style="list-style-type: none"> <li>Max. 85 m IE FC TP Marine/Trailing Cable 4x2 with IE FC RJ45 Plug 180 4x2</li> <li>Max. 75 m IE FC TP Marine/Trailing Cable 4x2 + 10 m TP Cord 4x2 via IE FC RJ45 Outlet</li> </ul>	
0 to 100 m	<ul style="list-style-type: none"> <li>Max. 100 m IE FC TP Standard Cable 4x2 with IE FC RJ45 Plug 180 4x2</li> <li>Max. 90 m IE FC TP Standard Cable 4x2 + 10 m TP Cord 4x2 via IE FC RJ45 Outlet</li> </ul>	
<b>Electrical data</b>		
Power supply	Rated voltage	24 V DC
	Voltage range	19.2 to 28.8 V DC Safe Extra Low Voltage (SELV)
	Design	3-terminal plug-in block
Current consumption	Typical	550 mA
Power loss at 24 V DC	Typical	13.2 W
Overvoltage category	CAT II	
Overvoltage protection at input	PTC resettable fuse (1.0 A / 60 V)	
<b>Permitted ambient conditions</b>		
Ambient temperature	During operation	-10 °C to +60 °C
	During storage	-40 °C to +80 °C
	During transportation	-40 °C to +80 °C
Relative humidity	During operation	≤ 95 % no condensation
Operating altitude	During operation	≤ 2,000 m above sea level at max. +60 °C ambient temperature
		< 3,000 m above sea level at max. +55 °C ambient temperature
		< 4,000 m above sea level at max. +50 °C ambient temperature
<b>Design, dimensions and weight</b>		
Immunity	EN 61000-6-2	
Emission	EN 61000-6-4	
Degree of protection	IP20	
MTBF (EN/IEC 61709; 40 °C)	168 years	

8.9 SCALANCE XB005G

Technical specifications	
Housing material	Polycarbonate (plastic)
Weight	220 g
Dimensions (W x H x D)	45 x 100 x 87 mm
Installation options	<ul style="list-style-type: none"> <li>• Mounting on a DIN rail</li> <li>• Wall mounting</li> </ul>
Switching properties	
Aging time	300 seconds
Max. number of learnable MAC addresses	8192
Response to LLDP frames	Blocking
Response to spanning tree BPDU frames	Forwarding
CoS acc. to IEEE 802.1Q	Yes
QoS priority queues	4
IEEE 802.1Q tags (VLAN ID, priority) transparent forwarding	Yes
Maximum frame size	1536 bytes
Forwarding of PRP frames (Parallel Redundancy Protocol)	Yes

**Note**

The number of IE switches of the SCALANCE XB-000 product line connected in a line influences the frame delay.

When a frame passes through IE switches of the SCALANCE XB-000 product line, it is delayed by the store and forward function of the switch

- with a 64 byte frame length by approx. 10 microseconds (at 100 Mbps)
- with a 1500 byte frame length by approx. 130 microseconds (at 100 Mbps)

This means the more devices of the SCALANCE XB-000 product line that the frame passes through, the longer the frame propagation time.

Table 8-13 Technical specifications of the SCALANCE XB005G (6GK5 005-0GA10-1AB2)

Technical specifications	
<b>Article number</b>	
SCALANCE XB005G	6GK5 005-0GA10-1AB2
<b>Attachment to Industrial Ethernet</b>	
Quantity	5
Design	RJ-45 jacks with MDI-X pinning
Properties	Half / full duplex
Transmission rate	10 / 100 / 1000 Mbps
<b>Permitted cable lengths (Industrial Ethernet)</b>	<b>Alternative combinations per length range</b>

Technical specifications	
0 to 55 m	<ul style="list-style-type: none"> <li>Max. 55 m IE TP Torsion Cable 4x2 with IE FC RJ45 Plug 180 4x2</li> <li>Max. 45 m IE TP Torsion Cable 4x2 with IE FC RJ45 + 10 m TP Cord 4x2 via IE FC RJ45 Outlet</li> </ul>
0 to 85 m	<ul style="list-style-type: none"> <li>Max. 85 m IE FC TP Marine/Trailing Cable 4x2 with IE FC RJ45 Plug 180 4x2</li> <li>Max. 75 m IE FC TP Marine/Trailing Cable 4x2 + 10 m TP Cord 4x2 via IE FC RJ45 Outlet</li> </ul>
0 to 100 m	<ul style="list-style-type: none"> <li>Max. 100 m IE FC TP Standard Cable 4x2 with IE FC RJ45 Plug 180 4x2</li> <li>Max. 90 m IE FC TP Standard Cable 4x2 + 10 m TP Cord 4x2 via IE FC RJ45 Outlet</li> </ul>

Electrical data		
Power supply	Rated voltage	24 V DC
	Voltage range	19.2 to 28.8 V DC Safe Extra Low Voltage (SELV)
	Design	3-terminal plug-in block
Current consumption	Typical	140 mA
Power loss at 24 V DC	Typical	3.4 W
Overvoltage category		CAT II
Overvoltage protection at input		PTC resettable fuse (1.0 A / 60 V)

Permitted ambient conditions		
Ambient temperature	During operation	-10 °C to +60 °C
	During storage	-40 °C to +85 °C
	During transportation	-40 °C to +85 °C
Relative humidity	During operation	≤ 95 % no condensation
Operating altitude	During operation	≤ 2,000 m above sea level at max. +60 °C ambient temperature
		< 3,000 m above sea level at max. +55 °C ambient temperature
		< 4,000 m above sea level at max. +50 °C ambient temperature

Design, dimensions and weight	
Immunity	EN 61000-6-2
Emission	EN 61000-6-4
Degree of protection	IP20
MTBF (EN/IEC 61709; 40 °C)	232 years
Housing material	Polycarbonate (plastic)
Weight	172 g
Dimensions (W x H x D)	45 x 100 x 87 mm
Installation options	<ul style="list-style-type: none"> <li>Mounting on a DIN rail</li> <li>Wall mounting</li> </ul>

Switching properties	
Aging time	45 seconds
Max. number of learnable MAC addresses	16000
Response to LLDP frames	Blocking

8.10 SCALANCE XB008G

Technical specifications	
Response to spanning tree BPDU frames	Forwarding
CoS acc. to IEEE 802.1Q	Yes
QoS priority queues	8
IEEE 802.1Q tags (VLAN ID, priority)	Yes
transparent forwarding	
Maximum frame size	1536 bytes
Forwarding of PRP frames (Parallel Redundancy Protocol)	Yes

**Note**

The number of IE switches of the SCALANCE XB-000 product line connected in a line influences the frame delay.

When a frame passes through IE switches of the SCALANCE XB-000 product line, it is delayed by the store and forward function of the switch

- with a 64 byte frame length by approx. 10 microseconds (at 100 Mbps)
- with a 1500 byte frame length by approx. 130 microseconds (at 100 Mbps)

This means the more devices of the SCALANCE XB-000 product line that the frame passes through, the longer the frame propagation time.

## 8.10 SCALANCE XB008G

**Note**

Note the article number in the technical specifications.

Table 8-14 Technical specifications of the SCALANCE XB008G (6GK5 008-0GA00-1AB2)

Technical specifications	
<b>Article number</b>	
SCALANCE XB008G	6GK5 008-0GA00-1AB2
<b>Attachment to Industrial Ethernet</b>	
Quantity	8
Design	RJ-45 jacks with MDI-X pinning
Properties	Half / full duplex
Transmission rate	10 / 100 / 1000 Mbps
<b>Permitted cable lengths (Industrial Ethernet)</b>	<b>Alternative combinations per length range</b>

**Technical specifications**

0 to 55 m	<ul style="list-style-type: none"> <li>Max. 55 m IE TP Torsion Cable 4x2 with IE FC RJ45 Plug 180 4x2</li> <li>Max. 45 m IE TP Torsion Cable 4x2 with IE FC RJ45 + 10 m TP Cord 4x2 via IE FC RJ45 Outlet</li> </ul>
0 to 85 m	<ul style="list-style-type: none"> <li>Max. 85 m IE FC TP Marine/Trailing Cable 4x2 with IE FC RJ45 Plug 180 4x2</li> <li>Max. 75 m IE FC TP Marine/Trailing Cable 4x2 + 10 m TP Cord 4x2 via IE FC RJ45 Outlet</li> </ul>
0 to 100 m	<ul style="list-style-type: none"> <li>Max. 100 m IE FC TP Standard Cable 4x2 with IE FC RJ45 Plug 180 4x2</li> <li>Max. 90 m IE FC TP Standard Cable 4x2 + 10 m TP Cord 4x2 via IE FC RJ45 Outlet</li> </ul>

**Electrical data**

Power supply	Rated voltage	24 V DC
	Voltage range	19.2 to 28.8 V DC Safe Extra Low Voltage (SELV)
	Design	3-terminal plug-in block
Current consumption	Typical	650 mA
Power loss at 24 V DC	Typical	15.6 W
Overvoltage category		CAT II
Overvoltage protection at input		PTC resettable fuse (1.0 A / 60 V)

**Permitted ambient conditions**

Ambient temperature	During operation	-10 °C to +60 °C
	During storage	-40 °C to +80 °C
	During transportation	-40 °C to +80 °C
Relative humidity	During operation	≤ 95 % no condensation
Operating altitude	During operation	≤ 2,000 m above sea level at max. +60 °C ambient temperature
		< 3,000 m above sea level at max. +55 °C ambient temperature
		< 4,000 m above sea level at max. +50 °C ambient temperature

**Design, dimensions and weight**

Immunity	EN 61000-6-2
Emission	EN 61000-6-4
Degree of protection	IP20
MTBF (EN/IEC 61709; 40 °C)	138 years
Housing material	Polycarbonate (plastic)
Weight	260 g
Dimensions (W x H x D)	45 x 100 x 87 mm
Installation options	<ul style="list-style-type: none"> <li>Mounting on a DIN rail</li> <li>Wall mounting</li> </ul>

**Switching properties**

Aging time	300 seconds
Max. number of learnable MAC addresses	8192
Response to LLDP frames	Blocking

8.10 SCALANCE XB008G

Technical specifications	
Response to spanning tree BPDU frames	Forwarding
CoS acc. to IEEE 802.1Q	Yes
QoS priority queues	4
IEEE 802.1Q tags (VLAN ID, priority) transparent forwarding	Yes
Maximum frame size	1536 bytes
Forwarding of PRP frames (Parallel Redundancy Protocol)	Yes

**Note**

The number of IE switches of the SCALANCE XB-000 product line connected in a line influences the frame delay.

When a frame passes through IE switches of the SCALANCE XB-000 product line, it is delayed by the store and forward function of the switch

- with a 64 byte frame length by approx. 10 microseconds (at 100 Mbps)
- with a 1500 byte frame length by approx. 130 microseconds (at 100 Mbps)

This means the more devices of the SCALANCE XB-000 product line that the frame passes through, the longer the frame propagation time.

Table 8-15 Technical specifications of the SCALANCE XB008G (6GK5 008-0GA10-1AB2)

Technical specifications	
<b>Article number</b>	
SCALANCE XB008G	6GK5 008-0GA10-1AB2
<b>Attachment to Industrial Ethernet</b>	
Quantity	8
Design	RJ-45 jacks with MDI-X pinning
Properties	Half / full duplex
Transmission rate	10 / 100 / 1000 Mbps
<b>Permitted cable lengths (Industrial Ethernet)</b>	<b>Alternative combinations per length range</b>
0 to 55 m	<ul style="list-style-type: none"> <li>• Max. 55 m IE TP Torsion Cable 4x2 with IE FC RJ45 Plug 180 4x2</li> <li>• Max. 45 m IE TP Torsion Cable 4x2 with IE FC RJ45 + 10 m TP Cord 4x2 via IE FC RJ45 Outlet</li> </ul>
0 to 85 m	<ul style="list-style-type: none"> <li>• Max. 85 m IE FC TP Marine/Trailing Cable 4x2 with IE FC RJ45 Plug 180 4x2</li> <li>• Max. 75 m IE FC TP Marine/Trailing Cable 4x2 + 10 m TP Cord 4x2 via IE FC RJ45 Outlet</li> </ul>
0 to 100 m	<ul style="list-style-type: none"> <li>• Max. 100 m IE FC TP Standard Cable 4x2 with IE FC RJ45 Plug 180 4x2</li> <li>• Max. 90 m IE FC TP Standard Cable 4x2 + 10 m TP Cord 4x2 via IE FC RJ45 Outlet</li> </ul>
<b>Electrical data</b>	

<b>Technical specifications</b>		
Power supply	Rated voltage	24 V DC
	Voltage range	19.2 to 28.8 V DC Safe Extra Low Voltage (SELV)
	Design	3-terminal plug-in block
Current consumption	Typical	190 mA
Power loss at 24 V DC	Typical	4.6 W
Overvoltage category		CAT II
Overvoltage protection at input		PTC resettable fuse (1.0 A / 60 V)
<b>Permitted ambient conditions</b>		
Ambient temperature	During operation	-10 °C to +60 °C
	During storage	-40 °C to +85 °C
	During transportation	-40 °C to +85 °C
Relative humidity	During operation	≤ 95 % no condensation
Operating altitude	During operation	≤ 2,000 m above sea level at max. +60 °C ambient temperature
		< 3,000 m above sea level at max. +55 °C ambient temperature
		< 4,000 m above sea level at max. +50 °C ambient temperature
<b>Design, dimensions and weight</b>		
Immunity	EN 61000-6-2	
Emission	EN 61000-6-4	
Degree of protection	IP20	
MTBF (EN/IEC 61709; 40 °C)	217 years	
Housing material	Polycarbonate (plastic)	
Weight	188 g	
Dimensions (W x H x D)	45 x 100 x 87 mm	
Installation options	<ul style="list-style-type: none"> <li>• Mounting on a DIN rail</li> <li>• Wall mounting</li> </ul>	
<b>Switching properties</b>		
Aging time	45 seconds	
Max. number of learnable MAC addresses	16000	
Response to LLDP frames	Blocking	
Response to spanning tree BPDU frames	Forwarding	
CoS acc. to IEEE 802.1Q	Yes	
QoS priority queues	8	
IEEE 802.1Q tags (VLAN ID, priority) transparent forwarding	Yes	
Maximum frame size	1536 bytes	
Forwarding of PRP frames (Parallel Redundancy Protocol)	Yes	

8.11 Mechanical stability (in operation) XB-000

**Note**

The number of IE switches of the SCALANCE XB-000 product line connected in a line influences the frame delay.

When a frame passes through IE switches of the SCALANCE XB-000 product line, it is delayed by the store and forward function of the switch

- with a 64 byte frame length by approx. 10 microseconds (at 100 Mbps)
- with a 1500 byte frame length by approx. 130 microseconds (at 100 Mbps)

This means the more devices of the SCALANCE XB-000 product line that the frame passes through, the longer the frame propagation time.

## 8.11 Mechanical stability (in operation) XB-000

### Mechanical stability (in operation)

Device	DIN EN 60068-2-6 vibration	DIN EN 60068-2-6 vibration ship building	DIN EN 60068-2-27 shock
	5 - 8.51 Hz: 7.0 mm <sup>PP</sup> 8.51 - 150 Hz: 10 m/s <sup>2</sup> 1 oct/min, 20 sweeps	2 - 13.2 Hz: 2.0 mm <sup>PP</sup> 13.2 - 100 Hz: 7 m/s <sup>2</sup> 2 min/oct, 1 sweep	150 m/s <sup>2</sup> , 11 ms duration 6 shocks per axis
XB004-1	●	●	●
XB004-2	●	●	●
XB004-1LD	●	●	●
XB004-2LD	●	●	●
XB005	●	●	●
XB008	●	●	●

Device	DIN EN 60068-2-6 vibration	DIN EN 60068-2-6 vibration	DIN EN 60068-2-6 vibration ship building	DIN EN 60068-2-27 shock	DIN EN 60068-2-29 permanent shock
	5 - 8.51 Hz: 7.0 mm <sup>PP</sup> 8.51 - 150 Hz: 10 m/s <sup>2</sup> 1 oct/min, 20 sweeps	5 - 8.51 Hz: 7.0 mm <sup>PP</sup> 8.51 - 500 Hz: 10 m/s <sup>2</sup> 1 oct/min, 20 sweeps	2 - 13.2 Hz: 2.0 mm <sup>PP</sup> 13.2 - 100 Hz: 7 m/s <sup>2</sup> 2 min/oct, 1 sweep	150 m/s <sup>2</sup> , 11 ms duration 6 shocks per axis	250 m/s <sup>2</sup> , 6 ms duration 1000 shocks per axis
XB004-1G	●	●	●	●	●
XB004-1LDG	●	●	●	●	●
XB005G	●	●	●	●	●
XB008G	●	●	●	●	●



## Dimension drawings

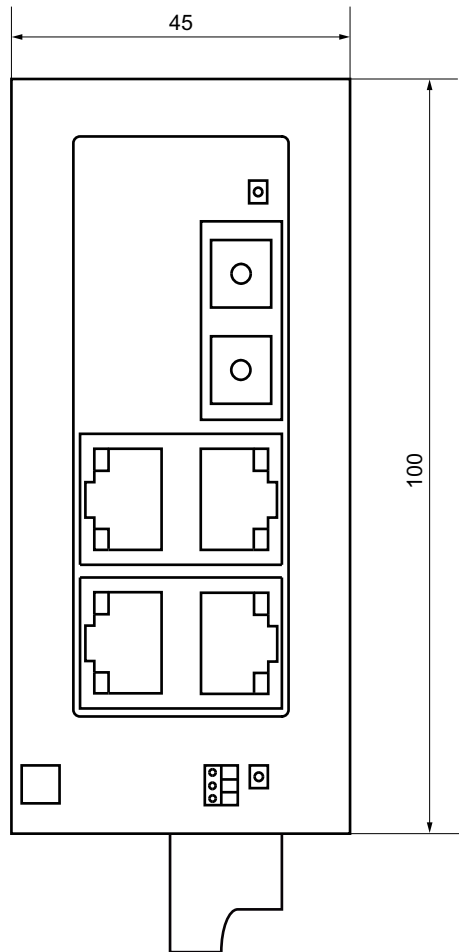

Figure 9-1 Dimension drawing, front view (example: SCALANCE XB004-1)

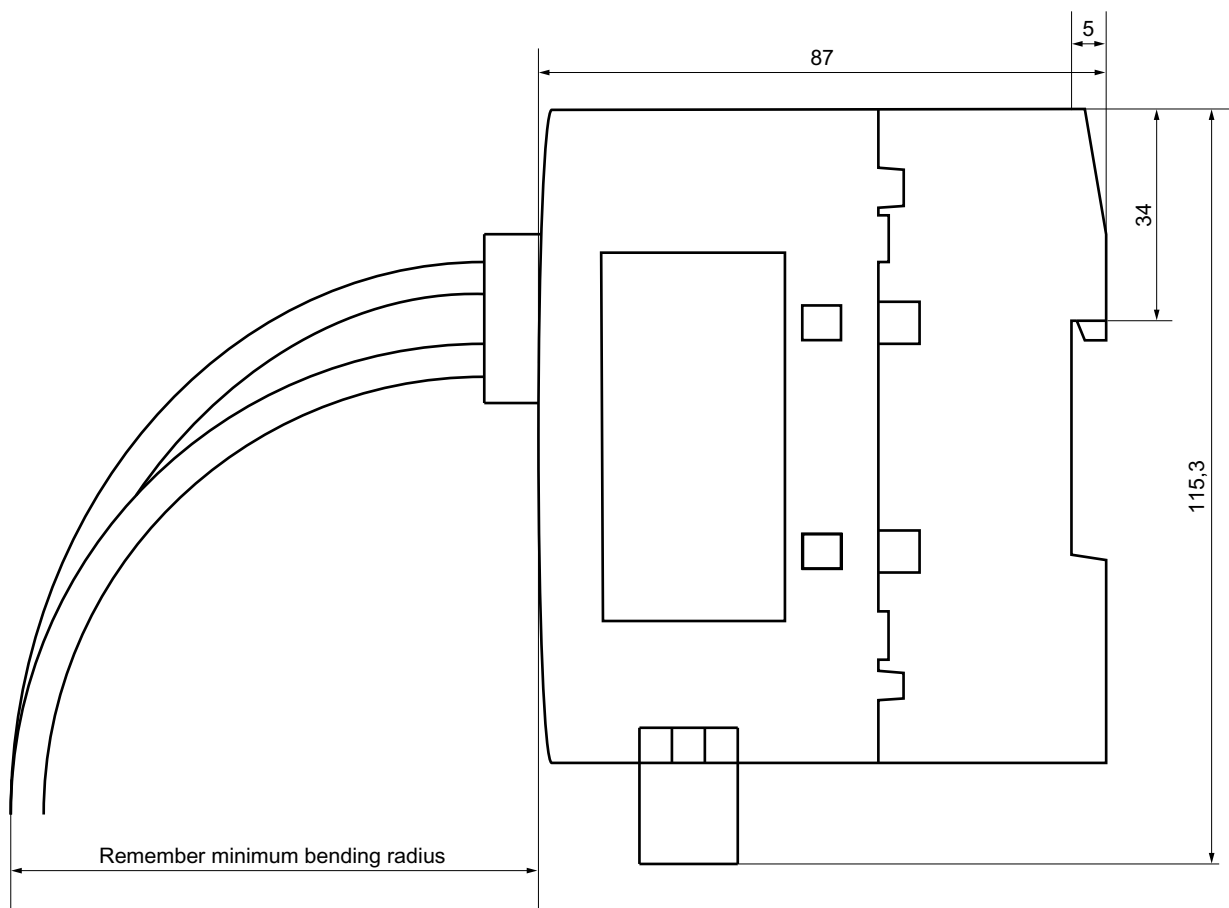

Figure 9-2 Dimension drawing, side view (example: SCALANCE XB004-1)

---

**Note**

The minimum bending radius of the optical and electrical signal cables used must not be fallen below.

---

Example:

SIMATIC NET FO standard cable - bending radius  $\geq 70$  mm

## Approvals

The SIMATIC NET products described in these Operating Instructions have the approvals listed below.

---

### Note

#### Issued approvals on the type plate of the device

The specified approvals apply only when the corresponding mark is printed on the product. You can check which of the following approvals have been granted for your product by the markings on the type plate.

---

### Current approvals on the Internet

You will find the current approvals for the product on the Internet pages of Siemens Industry Online Support (<https://support.industry.siemens.com/cs/ww/en/ps/15273/cert>).

### Notes for the manufacturers of machines

The devices are not machines in the sense of the EC Machinery Directive. There is therefore no declaration of conformity relating to the EC Machinery Directive 2006/42/EC for these devices.

If the devices are part of the equipment of a machine, they must be included into the EU declaration of conformity procedure by the manufacturer of the machine.

### EC declaration of conformity



The SIMATIC NET products described in these operating instructions meet the requirements and safety objectives of the following EC directives and comply with the harmonized European standards (EN) which are published in the official documentation of the European Union and here.

- **2014/34/EU (ATEX explosion protection directive)**  
Directive of the European Parliament and the Council of 26 February 2014 on the approximation of the laws of the member states concerning equipment and protective systems intended for use in potentially explosive atmospheres, official journal of the EU L96, 29/03/2014, pages. 309-356
- **2014/30/EU (EMC)**  
EMC directive of the European Parliament and of the Council of February 26, 2014 on the approximation of the laws of the member states relating to electromagnetic compatibility; official journal of the EU L96, 29/03/2014, pages. 79-106
- **2011/65/EU (RoHS)**  
Directive of the European Parliament and of the Council of 8 June 2011 on the restriction of the use of certain hazardous substances in electrical and electronic equipment, official journal of the EC L174, 01/07/2011, pages 88-110

You will find the EC declaration of conformity for these products on the Internet pages of Siemens Industry Online Support (<https://support.industry.siemens.com/cs/ww/en/ps/15273/cert>).

The EC Declaration of Conformity is available for all responsible authorities at:

Siemens Aktiengesellschaft

Digital Industries  
DE-76181 Karlsruhe  
Germany

## UK Declaration of Conformity



The UK declaration of conformity is available to all responsible authorities at:

Siemens Aktiengesellschaft  
Digital Industries  
Process Automation  
DE-76181 Karlsruhe  
Germany

### Importer UK:

Siemens plc,  
Manchester M20 2UR

You can find the current UK Declaration of Conformity for these products on the Internet pages under Siemens Industry Online Support (<https://support.industry.siemens.com/cs/ww/en/ps/15273/cert>).

The SIMATIC NET products described in this document meet the requirements of the following directives:

- UK-Regulation  
SI 2016/1107 Equipment and Protective Systems Intended for use in Potentially Explosive Atmospheres Regulations 2016, and related amendments
- EMC Regulation  
SI 2016/1091 Electromagnetic Compatibility Regulations 2016, and related amendments
- RoHS Regulation  
SI 2012/3032 Restriction of the Use of Certain Hazardous Substances in Electrical and Electronic Equipment Regulations 2012, and related amendments

## ATEX, IECEx, UKEX and CCC Ex certification

<p><b>! WARNING</b></p> <p><b>Risk of explosion in hazardous areas</b></p> <p>When using SIMATIC NET products in hazardous area zone 2, make absolutely sure that the associated conditions in the following document are adhered to:</p> <p>"SIMATIC NET Product Information Use of subassemblies/modules in a Zone 2 Hazardous Area".</p> <p>You will find this document</p> <ul style="list-style-type: none"> <li>• on the data medium that ships with some devices.</li> <li>• on the Internet pages under Siemens Industry Online Support (<a href="https://support.industry.siemens.com/cs/ww/en/view/78381013">https://support.industry.siemens.com/cs/ww/en/view/78381013</a>).</li> </ul> <p>Enter the document identification number "C234" as the search term.</p>
--

The markings of the electrical devices are:



II 3 G Ex ec IIC T4 Gc  
 DEKRA 18ATEX0025 X  
 DEKRA 21UKEX0001 X  
 IECEx DEK 18.0017X  
 Importer UK:  
 Siemens plc,  
 Manchester  
 M20 2UR  
 (Ex na IIC T4 Gc, not on the nameplate)  
 2020322310002626  
 2020322310002915  
 2020322310002987

The products meet the requirements of the following standards:

- EN/IEC 60079-7, GB 3836.8
- EN IEC/IEC 60079-0, GB 3836.1

You will find the current versions of the standards in the currently valid certificates.

### Note for devices with CLASS 1 LASER

Important note on products certified according to Type Examination Certificate KEMA 07ATEX0145 X as of Issue 95 / DEKRA 18ATEX0025 X and IECEx Certificate of Conformity DEK 14.0025X as of Issue 43 / DEK 18.0017X and containing Class 1 optical radiation sources.

---

#### Note

##### CLASS 1 LASER

The device contains optical radiation sources which comply with the limits of Class 1 according to IEC 60825-1. Fiber-optic cables connected to these optical radiation sources may therefore be routed either to or through hazardous areas requiring Category 2G, 3G, 2D or 3D equipment.

---

### EMC (electromagnetic compatibility)

The SIMATIC NET products described in these operating instructions meet the electromagnetic compatibility requirements according to the EU Directive 2014/30/EU as well as the UK-Regulation SI 2016/1091 and their associated amendments.

Applied standards:

- EN 61000-6-2 Electromagnetic compatibility (EMC) - Part 6-2: Generic standards - Immunity for industrial environments
- EN 61000-6-4 Electromagnetic compatibility (EMC) - Part 6-4: Generic standards - Emission standard for industrial environments

You will find the current versions of the standards in the currently valid EC/UK Declaration of Conformity.

### RoHS

The SIMATIC NET products described in these operating instructions meet the requirements on the restriction of the use of certain hazardous substances in electrical and electronic equipment according to the EU Directive 2011/65/EU as well as the UK-Regulation SI 2012/3032 and their associated amendments.

Applied standard:

- EN IEC 63000

### FM

The product meets the requirements of the standards:

- Factory Mutual Approval Standard Class Number 3611
- FM Hazardous (Classified) Location Electrical Equipment:  
Non Incendive / Class I / Division 2 / Groups A,B,C,D / T4 and  
Non Incendive / Class I / Zone 2 / Group IIC / T4

## cULus Approval for Information Technology Equipment



cULus Listed I. T. E.

Underwriters Laboratories Inc. complying with

- UL 60950-1 (Information Technology Equipment)
- CSA C22.2 No. 60950-1-03

Report no. E115352

## cULus approval for industrial control equipment

cULus Listed IND. CONT. EQ.

Underwriters Laboratories Inc. complying with

- UL 61010-2-201
- CAN/CSA-IEC 61010-2-201

Report no. E85972

## cULus for Hazardous Locations

ANSI/ISA 12.12.01-2007, CSA C22.2 No. 213-M1987

CL. 1, Div. 2 GP. A.B.C.D T..

CL. 1, Zone 2, GP, IIC, T..

(T.. = For detailed information on the temperature class, refer to the type plate)

## Note for Australia - RCM

The product meets the requirements of the RCM standard.

Applied standards:

- AS/NZS CISPR11 (Industrial, scientific and medical equipment - Radio-frequency disturbance characteristics - Limits and methods of measurement).
- EN 61000-6-4 Electromagnetic compatibility (EMC) - Part 6-4: Generic standards - Emission standard for industrial environments

You will find the current versions of the standards in the currently valid RCM SDoCs (Self-Declaration of Conformity).

### Marking for the customs union



EAC (Eurasian Conformity)

Eurasian Economic Union of Russia, Belarus, Armenia, Kazakhstan and Kyrgyzstan

Declaration of conformity according to the technical regulations of the customs union (TR ZU)

### MSIP 요구사항 - For Korea only

#### A급 기기(업무용 방송통신기자재)

이 기기는 업무용(A급) 전자파 적합기기로서 판매자 또는 사용자는 이 점을 주의하시기 바라며, 가정 외의 지역에서 사용하는 것을 목적으로 합니다.

### FDA and IEC marking

The following devices meet the FDA and IEC requirements listed below:

Device	CLASS 1 LASER Product
XB004-1	●
XB004-2	●
XB004-1LD	●
XB004-2LD	●
XB005	-
XB008	-
XB004-1G	●
XB004-1LDG	●
XB005G	-
XB008G	-



Figure 10-1 FDA and IEC marking

<p><b>⚠ CAUTION</b></p> <p>Use of controls or adjustments or performance of procedures other than those specified herein may result in hazardous radiation exposure.</p>
--



## Installation guidelines

The devices meet the requirements if you adhere to the installation and safety instructions contained in this documentation and in the following documentation when installing and operating the devices.

- "Industrial Ethernet / PROFINET Industrial Ethernet" System Manual (<https://support.industry.siemens.com/cs/ww/en/view/27069465>)
- "Industrial Ethernet / PROFINET - Passive Network Components" System Manual (<https://support.industry.siemens.com/cs/ww/en/view/84922825>)
- "EMC Installation Guidelines" configuration manual (<https://support.industry.siemens.com/cs/ww/en/view/60612658>)



### WARNING

#### Personal injury and property damage can occur

The installation of expansions that are not approved for SIMATIC NET products or their target systems may violate the requirements and regulations for safety and electromagnetic compatibility.

Only use expansions that are approved for the system.

### Note

The test was performed with a device and a connected communications partner that also meets the requirements of the standards listed above.

When operating the device with a communications partner that does not comply with these standards, adherence to the corresponding values cannot be guaranteed.



# Index

## A

Accessories, 16  
Approvals, 91  
Article numbers, 5, 57, 59, 61, 64, 66, 68, 70, 72, 74, 76, 78, 81, 82, 84, 86  
Attachment to Industrial Ethernet, 57, 59, 61, 66, 68, 70, 72, 74, 81, 82, 84, 86  
Auto polarity exchange, 28  
Autonegotiation, 28

## C

CE mark, 91  
Class 1 laser, 32, 33, 34  
Components of the product, 15  
Connection to Industrial Ethernet, 64, 76, 78

## D

defective, 56  
Design, dimensions and weight, 58, 60, 62, 65, 67, 69, 71, 73, 75, 77, 79, 81, 83, 85, 87  
Dimension drawing, 89  
    Bending radius, 90  
    From above, 89  
    Side view, 90

## E

Electrical data, 57, 60, 62, 64, 66, 69, 70, 73, 75, 77, 79, 81, 83, 85, 86  
Electrical/optical star topology, 12  
Error  
    LED display when voltage is too low, 56  
ESD directives, 8

## F

FO port, 30, 31  
    SCALANCE XB004-1G, 33  
    SCALANCE XB004-1LDG, 34  
    SCALANCE XB004-2, 31  
    SCALANCE XB004-2LD, 32  
    SCALANCE XB004-1, 30  
    SCALANCE XB004-1LD, 32

## G

Glossary, 6

## I

IE FC RJ-45 Plug 180, 52  
    Mounting, 53  
    Plugging in, 53  
    Pulling, 53  
Insulation between the TP ports, 28  
    SCALANCE XB004-1, 29  
    SCALANCE XB004-2, 29  
    SCALANCE XB005, 29  
    SCALANCE XB008, 30

## L

LED display, 56  
    Port LEDs, 35  
    Power LED, 35

## M

MDI / MDIX autocrossover function, 28  
Mounting, 40  
    Installation on a DIN rail, 41  
    Types of installation, 40  
    Wall mounting, 42

## N

Network topology, 11  
    Star topology, 11

## O

Optical connectors, 57, 59, 61, 64, 72, 74, 76, 78  
Optical parameters, 57, 60, 62, 64, 73, 75, 77, 79

## P

Permitted ambient conditions, 58, 60, 62, 65, 67, 69, 71, 73, 75, 77, 79, 81, 83, 85, 87

Permitted cable lengths, 57, 59, 61, 64, 66, 68, 70, 72, 74, 77, 79, 81, 82, 84, 86

Pin assignment, 27

Possible attachments

SCALANCE XB004-1G, 23

SCALANCE XB004-1LDG, 24

SCALANCE XB005G, 25

SCALANCE XB008G, 26

SCALANCE XB004-1, 17

SCALANCE XB004-1LD, 19

SCALANCE XB004-2, 18

Possible connections

SCALANCE XB004-2LD, 20

SCALANCE XB005, 21

SCALANCE XB008, 22

Product characteristics, 14

## R

Reduced voltage, 56

## S

Safety notices

for installation, 37

general, 9

Use in hazardous areas, 9, 37, 45

when connecting up, 45

SCALANCE XB004-1G

Article numbers, 72, 74

Attachment to Industrial Ethernet, 72, 74

Design, dimensions and weight, 73, 75

Electrical data, 73, 75

Frame delay time, 74, 76

Optical connectors, 72, 74

Optical parameters, 73, 75

Permitted ambient conditions, 73, 75

Permitted cable lengths, 72, 74

Switching properties, 73, 75

SCALANCE XB004-1LDG

Article numbers, 76, 78

Connection to Industrial Ethernet, 76, 78

Design, dimensions and weight, 77, 79

Electrical data, 77, 79

Frame delay time, 78, 80

Optical connectors, 76, 78

Optical parameters, 77, 79

Permitted ambient conditions, 77, 79

Permitted cable lengths, 77, 79

Switching properties, 78, 80

SCALANCE XB004-2

Article numbers, 59

Attachment to Industrial Ethernet, 59

Design, dimensions and weight, 60

Electrical data, 60

Frame delay time, 61

Optical connectors, 59

Optical parameters, 60

Permitted ambient conditions, 60

Permitted cable lengths, 59

Switching properties, 60

SCALANCE XB004-2LD

Article numbers, 64

Connection to Industrial Ethernet, 64

Design, dimensions and weight, 65

Electrical data, 64

Frame delay time, 66

Optical connectors, 64

Optical parameters, 64

Permitted ambient conditions, 65

Permitted cable lengths, 64

Switching properties, 65

SCALANCE XB005G

Article numbers, 81, 82

Attachment to Industrial Ethernet, 81, 82

Design, dimensions and weight, 81, 83

Electrical data, 81, 83

Frame delay time, 82, 84

Permitted ambient conditions, 81, 83

Permitted cable lengths, 81, 82

Switching properties, 82, 83

SCALANCE XB008G

Article numbers, 84, 86

Attachment to Industrial Ethernet, 84, 86

Design, dimensions and weight, 85, 87

Electrical data, 85, 86

Frame delay time, 86, 88

Permitted ambient conditions, 85, 87

Permitted cable lengths, 84, 86

Switching properties, 85, 87

SCALANCE XB004-1

Article numbers, 57

Attachment to Industrial Ethernet, 57

Design, dimensions and weight, 58

Electrical data, 57

Frame delay time, 59

Optical connectors, 57

Optical parameters, 57

Permitted ambient conditions, 58

Permitted cable lengths, 57

Switching properties, 58

- SCALANCE XB004-1LD
  - Article numbers, 61
  - Attachment to Industrial Ethernet, 61
  - Design, dimensions and weight, 62
  - Electrical data, 62
  - Frame delay time, 63
  - Optical connectors, 61
  - Optical parameters, 62
  - Permitted ambient conditions, 62
  - Permitted cable lengths, 61
  - Switching properties, 63
- SCALANCE XB005
  - Article numbers, 66
  - Attachment to Industrial Ethernet, 66
  - Design, dimensions and weight, 67
  - Electrical data, 66
  - Frame delay time, 68
  - Permitted ambient conditions, 67
  - Permitted cable lengths, 66
  - Switching properties, 67
- SCALANCE XB008
  - Article numbers, 68, 70
  - Attachment to Industrial Ethernet, 68, 70
  - Design, dimensions and weight, 69, 71
  - Electrical data, 69, 70
  - Frame delay time, 70, 72
  - Permitted ambient conditions, 69, 71
  - Permitted cable lengths, 68, 70
  - Switching properties, 69, 71
- SIMATIC NET glossary, 6
- SIMATIC NET manual, 6
- Switching properties, 58, 60, 63, 65, 67, 69, 71, 73, 75, 78, 80, 82, 83, 85, 87
- System manual, 6, 97

## T

- Technical specifications, 57, 59, 61, 64, 66, 68, 70, 72, 74, 76, 78, 81, 82, 84, 86
  - SCALANCE XB004-1G, 72, 74
  - SCALANCE XB004-1LDG, 76, 78
  - SCALANCE XB004-2, 59
  - SCALANCE XB004-2LD, 64
  - SCALANCE XB005G, 81, 82
  - SCALANCE XB008G, 84, 86
  - SCALANCE XB004-1, 57
  - SCALANCE XB004-1LD, 61
  - SCALANCE XB005, 66
  - SCALANCE XB008, 68, 70
- Twisted pair cable, 52

