



Edition

05/2022

EQUIPMENT MANUAL

SIMATIC

S7-1500 / ET 200MP

Digital input module
DI 32x24VDC HF (6ES7521-1BL00-0AB0)

support.industry.siemens.com

SIEMENS

SIMATIC

S7-1500/ET 200MP DI 32x24VDC HF digital input module (6ES7521-1BL00-0AB0)

Equipment Manual

Preface

S7-1500/ET 200MP
Documentation Guide

1

Product overview

2

Wiring

3

Parameters/address space

4

Interrupts/diagnostics
alarms

5

Technical specifications

6

Dimensional drawing

A



Parameter data records

B

Legal information

Warning notice system

This manual contains notices you have to observe in order to ensure your personal safety, as well as to prevent damage to property. The notices referring to your personal safety are highlighted in the manual by a safety alert symbol, notices referring only to property damage have no safety alert symbol. These notices shown below are graded according to the degree of danger.

 DANGER
indicates that death or severe personal injury will result if proper precautions are not taken.
 WARNING
indicates that death or severe personal injury may result if proper precautions are not taken.
 CAUTION
indicates that minor personal injury can result if proper precautions are not taken.
NOTICE
indicates that property damage can result if proper precautions are not taken.

If more than one degree of danger is present, the warning notice representing the highest degree of danger will be used. A notice warning of injury to persons with a safety alert symbol may also include a warning relating to property damage.

Qualified Personnel

The product/system described in this documentation may be operated only by **personnel qualified** for the specific task in accordance with the relevant documentation, in particular its warning notices and safety instructions. Qualified personnel are those who, based on their training and experience, are capable of identifying risks and avoiding potential hazards when working with these products/systems.

Proper use of Siemens products

Note the following:

 WARNING
Siemens products may only be used for the applications described in the catalog and in the relevant technical documentation. If products and components from other manufacturers are used, these must be recommended or approved by Siemens. Proper transport, storage, installation, assembly, commissioning, operation and maintenance are required to ensure that the products operate safely and without any problems. The permissible ambient conditions must be complied with. The information in the relevant documentation must be observed.

Trademarks

All names identified by ® are registered trademarks of Siemens AG. The remaining trademarks in this publication may be trademarks whose use by third parties for their own purposes could violate the rights of the owner.

Disclaimer of Liability

We have reviewed the contents of this publication to ensure consistency with the hardware and software described. Since variance cannot be precluded entirely, we cannot guarantee full consistency. However, the information in this publication is reviewed regularly and any necessary corrections are included in subsequent editions.

Preface

Purpose of the documentation

This manual supplements the S7-1500/ET 200MP (<https://support.industry.siemens.com/cs/ww/en/view/59191792>) system manual.

Functions that relate in general to the systems are described in this system manual.

The information provided in this manual and in the system/function manuals supports you in commissioning the systems.

Changes compared to previous version

Compared to the previous version, this manual contains the following changes:

- Clock synchronization possible in counting mode. In the technical specifications, the counting frequency is increased from 3 kHz to 6 kHz.
- New licensing conditions and copyright information of the Open Source Software
- New technical specifications

Conventions

CPU: The term "CPU" is used in this manual both for the CPUs of the S7-1500 automation system and for interface modules of the ET 200MP distributed I/O system.

STEP 7: In this documentation, "STEP 7" is used as a synonym for all versions of the configuration and programming software "STEP 7 (TIA Portal)".

DI mode: DI 32x24VDC HF as digital input module with 32 digital inputs (channels 0 to 31).

Counting mode: DI 32x24VDC HF as digital input module with 2 counters (channels 0 and 1) and 30 digital inputs (channels 2 to 31).

Please also observe notes marked as follows:

Note

A note contains important information on the product described in the documentation, on the handling of the product or on the section of the documentation to which particular attention should be paid.

Recycling and disposal

For environmentally friendly recycling and disposal of your old equipment, contact a certified electronic waste disposal company and dispose of the equipment according to the applicable regulations in your country.

Siemens provides products and solutions with industrial security functions that support the secure operation of plants, systems, machines and networks.

In order to protect plants, systems, machines and networks against cyber threats, it is necessary to implement – and continuously maintain – a holistic, state-of-the-art industrial security concept. Siemens' products and solutions constitute one element of such a concept.

Customers are responsible for preventing unauthorized access to their plants, systems, machines and networks. Such systems, machines and components should only be connected to an enterprise network or the internet if and to the extent such a connection is necessary and only when appropriate security measures (e.g. firewalls and/or network segmentation) are in place.

For additional information on industrial security measures that may be implemented, please visit (<https://www.siemens.com/industrialsecurity>).

Siemens' products and solutions undergo continuous development to make them more secure. Siemens strongly recommends that product updates are applied as soon as they are available and that the latest product versions are used. Use of product versions that are no longer supported, and failure to apply the latest updates may increase customers' exposure to cyber threats.

To stay informed about product updates, subscribe to the Siemens Industrial Security RSS Feed visit (<https://www.siemens.com/cert>).

Open Source Software

Open-source software is used in the firmware of the product described. Open Source Software is provided free of charge. We are liable for the product described, including the open-source software contained in it, pursuant to the conditions applicable to the product. Siemens accepts no liability for the use of the open source software over and above the intended program sequence, or for any faults caused by modifications to the software.

For legal reasons, we are obliged to publish the original text of the license conditions and copyright notices. Please read the information relating to this on the Internet.

Table of contents

	Preface	3
1	S7-1500/ET 200MP Documentation Guide	6
1.1	S7-1500 / ET 200MP Documentation Guide	6
1.2	SIMATIC Technical Documentation	8
1.3	Tool support	9
1.3.1	Tool support	10
2	Product overview	12
2.1	Properties	12
2.2	Functions	15
2.2.1	Count	15
3	Wiring	17
4	Parameters/address space	19
4.1	Parameter	19
4.1.1	Parameters DI mode	20
4.1.2	Explanation of the parameters of the DI mode	21
4.1.3	Parameters of the Counting mode	22
4.1.4	Explanation of the parameters of the Counting mode	23
4.2	Address space	25
4.2.1	Address space DI mode	26
4.2.2	Address space Counting mode	30
4.2.3	Examples of counting	34
5	Interrupts/diagnostics alarms	39
5.1	Status and error displays	39
5.2	Interrupts	41
5.3	Diagnostics alarms	43
6	Technical specifications	44
A	Dimensional drawing	48
B	Parameter data records	50
B.1	Parameter assignment and structure of the parameter data records	50
B.2	Structure of the parameter data records DI mode	51
B.3	Structure of the parameter data records Counting mode	53

S7-1500/ET 200MP Documentation Guide

1.1 S7-1500 / ET 200MP Documentation Guide



The documentation for the SIMATIC S7-1500 automation system and the ET 200MP distributed I/O system is arranged into three areas.

This arrangement enables you to access the specific content you require. Changes and supplements to the manuals are documented in a Product Information.

You can download the documentation free of charge from the Internet (<https://support.industry.siemens.com/cs/ww/en/view/109742691>).

Basic information



The System Manual and Getting Started describe in detail the configuration, installation, wiring and commissioning of the SIMATIC S7-1500 and ET 200MP systems.

The STEP 7 online help supports you in the configuration and programming.

Examples:

- Getting Started S7-1500
- S7-1500/ET 200MP System Manual
- Online help TIA Portal

Device information



Equipment manuals contain a compact description of the module-specific information, such as properties, wiring diagrams, characteristics and technical specifications.

Examples:

- Equipment Manuals CPUs
- Equipment Manuals Interface Modules
- Equipment Manuals Digital Modules
- Equipment Manuals Analog Modules
- Equipment Manuals Communications Modules
- Equipment Manuals Technology Modules
- Equipment Manuals Power Supply Modules

General information



The function manuals contain detailed descriptions on general topics relating to the SIMATIC S7-1500 and ET 200MP systems.

Examples:

- Function Manual Diagnostics
- Function Manual Communication
- Function Manual Motion Control
- Function Manual Web Server
- Function Manual Cycle and Response Times
- PROFINET Function Manual
- PROFIBUS Function Manual

Product Information

Changes and supplements to the manuals are documented in a Product Information. The Product Information takes precedence over the device and system manuals.

You can find the latest Product Information on the S7-1500 and ET 200MP systems on the Internet (<https://support.industry.siemens.com/cs/de/en/view/68052815>).

Manual Collection S7-1500/ET 200MP

The Manual Collection contains the complete documentation on the SIMATIC S7-1500 automation system and the ET 200MP distributed I/O system gathered together in one file.

You can find the Manual Collection on the Internet.

(<https://support.industry.siemens.com/cs/ww/en/view/86140384>)

SIMATIC S7-1500 comparison list for programming languages

The comparison list contains an overview of which instructions and functions you can use for which controller families.

You can find the comparison list on the Internet

(<https://support.industry.siemens.com/cs/ww/en/view/86630375>).

1.2 SIMATIC Technical Documentation

Additional SIMATIC documents will complete your information. You can find these documents and their use at the following links and QR codes.

The Industry Online Support gives you the option to get information on all topics. Application examples support you in solving your automation tasks.

Overview of the SIMATIC Technical Documentation

Here you will find an overview of the SIMATIC documentation available in SIOS:



Industry Online Support International
(<https://support.industry.siemens.com/cs/ww/en/view/109742705>)

Watch this short video to find out where you can find the overview directly in SIOS and how to use SIOS on your mobile device:



Quick introduction to the technical documentation of automation products per video (<https://support.industry.siemens.com/cs/us/en/view/109780491>)



YouTube video: Siemens Automation Products - Technical Documentation at a Glance (<https://youtu.be/TwLSxxRQsA>)

mySupport

With "mySupport" you can get the most out of your Industry Online Support.

Registration	You must register once to use the full functionality of "mySupport". After registration, you can create filters, favorites and tabs in your personal workspace.
Support requests	Your data is already filled out in support requests, and you can get an overview of your current requests at any time.
Documentation	In the Documentation area you can build your personal library.
Favorites	You can use the "Add to mySupport favorites" to flag especially interesting or frequently needed content. Under "Favorites", you will find a list of your flagged entries.
Recently viewed articles	The most recently viewed pages in mySupport are available under "Recently viewed articles".
CAX data	The CAX data area gives you access to the latest product data for your CAX or CAE system. You configure your own download package with a few clicks: <ul style="list-style-type: none"> • Product images, 2D dimension drawings, 3D models, internal circuit diagrams, EPLAN macro files • Manuals, characteristics, operating manuals, certificates • Product master data

You can find "mySupport" on the Internet. (<https://support.industry.siemens.com/My/ww/en>)

Application examples

The application examples support you with various tools and examples for solving your automation tasks. Solutions are shown in interplay with multiple components in the system - separated from the focus on individual products.

You can find the application examples on the Internet.
(<https://support.industry.siemens.com/cs/ww/en/ps/ae>)

1.3 Tool support

1.3.1 Tool support

The tools described below support you in all steps: from planning, over commissioning, all the way to analysis of your system.

TIA Selection Tool

The TIA Selection Tool tool supports you in the selection, configuration, and ordering of devices for Totally Integrated Automation (TIA).

As successor of the SIMATIC Selection Tools , it assembles the configuration editors for automation technology already familiar into a single tool.

With the TIA Selection Tool , you can generate a complete order list from your product selection or product configuration.

You can find the TIA Selection Tool on the Internet.

(<https://support.industry.siemens.com/cs/ww/en/view/109767888>)

SIMATIC Automation Tool

You can use the SIMATIC Automation Tool to perform commissioning and maintenance activities on various SIMATIC S7 stations as bulk operations independent of TIA Portal.

The SIMATIC Automation Tool offers a wide range of functions:

- Scanning of a PROFINET/Ethernet system network and identification of all connected CPUs
- Assignment of addresses (IP, subnet, Gateway) and device name (PROFINET device) to a CPU
- Transfer of the date and the programming device/PC time converted to UTC time to the module
- Program download to CPU
- RUN/STOP mode switchover
- CPU localization through LED flashing
- Reading out of CPU error information
- Reading the CPU diagnostic buffer
- Reset to factory settings
- Firmware update of the CPU and connected modules

You can find the SIMATIC Automation Tool on the Internet.

(<https://support.industry.siemens.com/cs/ww/en/view/98161300>)

PRONETA

SIEMENS PRONETA (PROFINET network analysis) is a commissioning and diagnostic tool for PROFINET networks. PRONETA Basic has two core functions:

- The "Network analysis" offers a quick overview of the PROFINET topology. It is possible to make simple parameter changes (for example, to the names and IP addresses of the devices). In addition, a quick and convenient comparison of the real configuration with a reference system is also possible.
- The "IO test" is a simple and rapid test of the wiring and the module configuration of a plant, including documentation of the test results.

You can find SIEMENS PRONETA Basic on the Internet:

(<https://support.industry.siemens.com/cs/ww/en/view/67460624>)

SIEMENS PRONETA Professional is a licensed product that offers you additional functions. It offers you simple asset management in PROFINET networks and supports operators of automation systems in automatic data collection/acquisition of the components used through various functions:

- The user interface (API) offers an access point to the automation cell to automate the scan functions using MQTT or a command line.
- With PROFlenergy diagnostics, you can quickly detect the current pause mode or the readiness for operation of devices that support PROFlenergy and change these as needed.
- The data record wizard supports PROFINET developers in reading and writing acyclic PROFINET data records quickly and easily without PLC and engineering.

You can find SIEMENS PRONETA Professional on the Internet:

(<https://www.siemens.com/proneta-professional>)

SINETPLAN

SINETPLAN, the Siemens Network Planner, supports you in planning automation systems and networks based on PROFINET. The tool facilitates professional and predictive dimensioning of your PROFINET installation as early as in the planning stage. In addition, SINETPLAN supports you during network optimization and helps you to exploit network resources optimally and to plan reserves. This helps to prevent problems in commissioning or failures during productive operation even in advance of a planned operation. This increases the availability of the production plant and helps improve operational safety.

The advantages at a glance

- Network optimization thanks to port-specific calculation of the network load
- Increased production availability thanks to online scan and verification of existing systems
- Transparency before commissioning through importing and simulation of existing STEP 7 projects
- Efficiency through securing existing investments in the long term and the optimal use of resources

You can find SINETPLAN on the Internet

(<https://new.siemens.com/global/en/products/automation/industrial-communication/profinet/sinetplan.html>).

Product overview

2.1 Properties

Article number:

6ES7521-1BL00-0AB0

View of the module

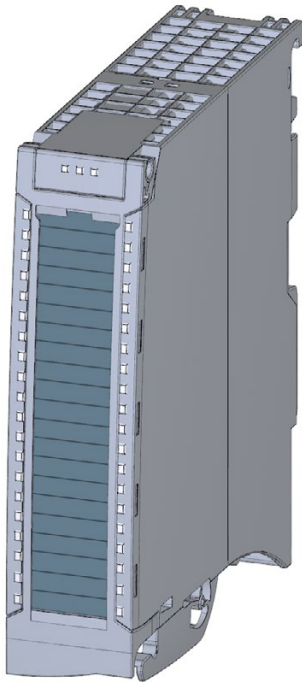

Figure 2-1 View of the DI 32x24VDC HF module

Properties

The module has the following technical properties:

- 32 digital inputs; electrically isolated in groups of 16
 - of which channel 0 and 1 optionally with counter function
- Rated input voltage 24 V DC
- Configurable input delay: 0.05 ms to 20 ms
- Configurable diagnostics (per channel)
- Configurable hardware interrupt (per channel)
- Suitable for switches and 2-/3-/4-wire proximity switches
- Hardware compatible with digital input module DI 16x24VDC HF (6ES7521-1BH00-0AB0)

The module supports the following functions:

Table 2- 1 Version dependencies of the module functions

Function	Firmware version of the module	Configuration software	
		STEP 7 (TIA Portal)	GSD file in STEP 7 (TIA Portal) V12 or higher, or STEP 7 V5.5 SP3 or higher
Firmware update	V1.0.0 or higher	V12 or higher	--- / X
Identification data I&M0 to I&M3	V1.0.0 or higher	V12 or higher	X
Parameter assignment in RUN	V1.0.0 or higher	V12 or higher	X
Isochronous mode	V1.0.0 or higher	V12 or higher	---
Module-internal Shared Input (MSI)	V2.0.0 or higher	V13 Update 3 or higher (PROFINET IO only)	X (PROFINET IO only)
Configurable submodules / submodules for Shared Device	V2.0.0 or higher	V13 Update 3 or higher (PROFINET IO only)	X (PROFINET IO only)
Channel 0 and 1 optionally with counter function*	V2.1.0 or higher	V13, SP1 with HSP 0118 or higher	X (PROFINET IO only)

* Requirement for counter function: Interface module IM 155-5 firmware version V3.0 or higher or CPU S7-15XX firmware version V1.7 or higher

You can configure the module with STEP 7 (TIA Portal) and with a GSD file.

Compatibility

The following table shows the compatibility of the modules and the dependencies between hardware functional status (FS) and firmware version (FW) used:

Hardware functional status	Firmware version	Note
FS01	V1.0.0 to V2.1.x	Upgrade possible between V1.0.0 to V2.1.x Downgrade possible from V2.1.x to V2.1.2 Downgrade possible from V2.1.1 to V1.0.0
FS02	V1.0.0 to V2.1.x	
FS03	V2.1.2 to V2.1.x	Upgrade to downgrade possible between V2.1.2 and V2.1.x
FS04	V2.2.0 or higher	Upgrade and downgrade possible between V2.2.0 and higher

Isochronous mode

When operating the following digital input modules, make sure that the digital input modules have at least one of the following firmware versions (FW) or higher. Otherwise, you may experience a high jitter in the application.

- For modules with functional status FS 03: FW V2.1.4

Accessories

The following accessories are supplied with the module and can also be ordered separately as spare parts:

- Labeling strips
- U connector
- Universal front door

Other components

The following component must be ordered separately:

Front connectors, including potential jumpers and cable ties

For more information on accessories, refer to the system manual S7-1500/ET 200MP (<https://support.industry.siemens.com/cs/ww/en/view/59191792>).

2.2 Functions

2.2.1 Count

Introduction

As of firmware version V2.1.0 of the module you have the option of using channels 0 and 1 in the "Count" mode. The other channels can be used as standard inputs (DI mode).

If do not use channels 0 and 1 in the "Count" mode, these channels can also be used as digital inputs. The two channels 0 and 1 can only be used as counter inputs together.

When counting, the edges of the digital input are acquired and evaluated accordingly e.g.:

- For counting single items up to a maximum limit
- For applications with repeating counting procedures

Reference

You will find the basics and additional information on the counting function in the function manual Counting, measuring and position detection (<http://support.automation.siemens.com/WW/view/en/59709820>).

Counting with channel 0 and channel 1

You control the counting function via the IO addresses of the module. These IO addresses are also known as the control interface (output addresses) and feedback interface (input addresses), see section Address space Counting mode (Page 30).

If you set the parameters of channels 0 and 1 for counting, you then have the following options:

- You influence the behavior if one of the counting limits is exceeded using
 - Stop counting.
 - Continue counting.
- The bit STS_DQ (bit in the feedback interface) signals that the counted value is in one of the following ranges depending on the parameter assignment:
 - Between a comparison value and the high counting limit.
 - Between a comparison value and the low counting limit.
- You can set a parameter for a hardware interrupt if a comparison event occurs for DQ.
- You can define counting limits and comparison values for counting from 0 ... 4294967295 ($2^{32}-1$).
- You can set start values or have the user program set load values for counting.

The count direction is only up.

Reference

You will find examples of counting with channels 0 and 1 in the section Examples of counting (Page 34)

This section contains the block diagram of the module and outlines various wiring options.

You will find information on wiring the front connector, establishing a cable shield, etc in the system manual S7-1500/ET 200MP

(<http://support.automation.siemens.com/WW/view/en/59191792>) in section Wiring.

Wiring and block diagram

The figure below shows you how to wire the module and the assignment of the channels to the addresses (input byte a to input byte d). You can set parameters so that channels 0 and 1 are used for counting. Channels 2 to 31 can continue to be used as digital inputs.

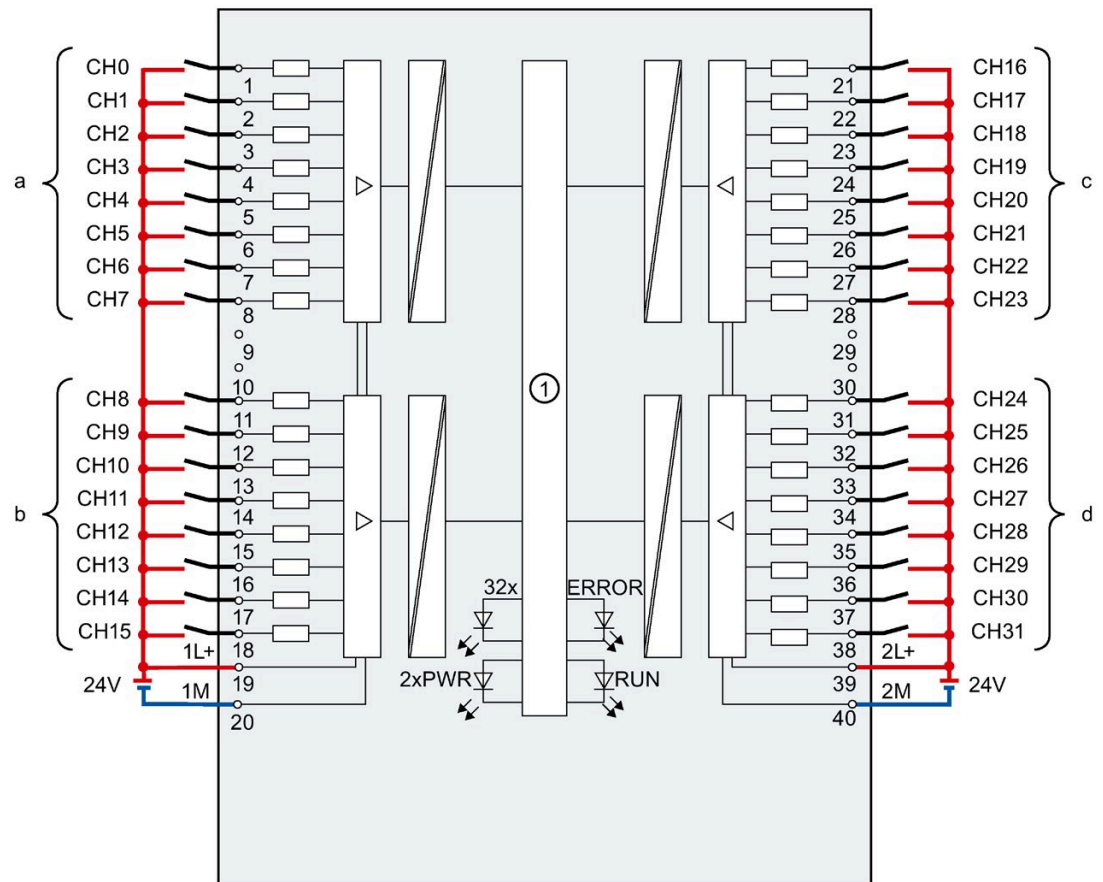

①	Backplane bus interface	CHx	Channel or channel status LED (green/red)
xL+	Supply voltage 24 V DC	RUN	Status display LED (green)
xM	Ground	ERROR	Error display LED (red)
		PWR	POWER supply voltage LED (green)

Figure 3-1 Block diagram and terminal assignment

Resistor circuitry of the encoders

To detect a wire break, it is necessary that enough quiescent current is flowing even when the encoder contacts are open. Connect a resistor of 25 kΩ to 45 kΩ with 0.25 W to the encoder contacts for this reason.

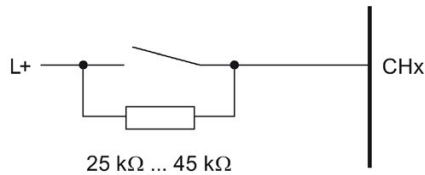

Figure 3-2 Resistor circuitry of the encoders

Tip: Using the potential jumpers

If you want to supply both load groups with the same potential (non-isolated), use the potential jumpers supplied with the front connector. This helps you to avoid having to terminate two wires to one terminal.

Proceed as follows:

1. Connect the 24 V DC supply voltage to terminals 19 and 20.
2. Insert the potential jumpers between terminals 19 and 39 (xL+) and between terminals 20 and 40 (xM).
3. Use the terminals 39 and 40 to distribute the potential to the next module

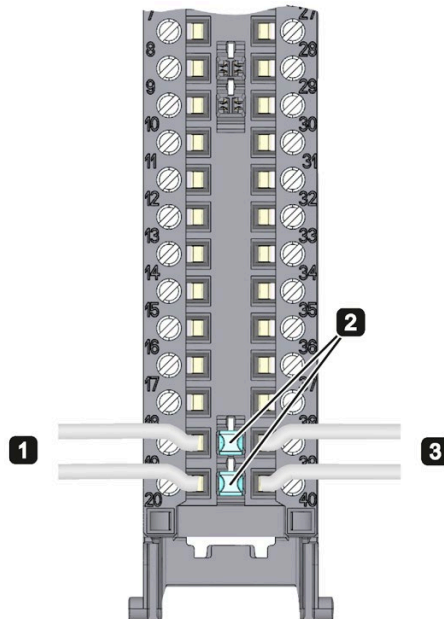

Figure 3-3 Using the potential jumpers

Note

Ensure that the maximum current load of 8 A per potential jumper is not exceeded.

Parameters/address space

4.1 Parameter

DI 32x24VDC HF parameters

When you assign the module parameters in STEP 7, you use various parameters to specify the module properties. The parameters that can be set depend on whether you use the module in standard mode or in counter mode. You will find the parameters in section Parameters DI mode (Page 20) or section Parameters of the Counting mode (Page 22). The effective range of the configurable parameters depends on the type of configuration. The following configurations are possible:

- Central operation with a S7-1500 CPU
- Distributed operation on PROFINET IO in an ET 200MP system
- Distributed operation on PROFIBUS DP in an ET 200MP system

For parameter reassignment in the user program, the parameters are transferred to the module with the WRREC instruction (parameter reassignment in RUN) using data records; see section Parameter assignment and structure of the parameter data records (Page 50).

4.1 Parameter

4.1.1 Parameters DI mode

Parameters of the DI 32x24VDC HF in the DI mode

In the following table, you will find the parameters in the "DI mode". These parameters apply to channels 0 to 31.

Table 4-1 Settable parameters and their defaults in the DI mode

Parameter	Range of values	Default setting	Parameter reassignment in RUN	Range of effectiveness with configuration software, e.g. STEP 7	
				Integrated in the hardware catalog as of STEP 7, V13 SP1 or GSD file PROFINET IO	GSD file PROFIBUS DP
Diagnostics					
• No supply voltage L+	Yes/No	No	Yes	Channel*	Channel group**
• Wire break	Yes/No	No	Yes	Channel	Channel group**
Input delay	0.05 ms, 0.1 ms, 0.4 ms, 1.6 ms, 3.2 ms, 12.8 ms, 20 ms	3.2 ms; for isochronous mode 0.05 ms (cannot be changed)	Yes	Channel	Channel group**
Hardware interrupt***					
• Rising edge	Yes/No	No	Yes	Channel	Channel
• Falling edge	Yes/No	No	Yes	Channel	Channel
• Rising and falling edge	Yes/No	No	Yes	Channel	Channel

* If you enable diagnostics for multiple channels, you will receive an alarm surge on failure of the supply voltage because each enabled channel will detect this fault.

You can prevent this message burst by enabling diagnostics for one channel only.

** The scope can be assigned for each channel during parameter assignment in RUN.

*** For the configuration as a 4 x 8-channel module, a maximum of 16 hardware interrupts can be configured (channels 0 to 15).

4.1.2 Explanation of the parameters of the DI mode

No supply voltage L+

Enabling of the diagnostics, with missing or too little supply voltage L+.

Wire break

Enabling diagnostics if the line to the encoder is interrupted.

Input delay

This parameter can be used to suppress signal disruptions. Changes to the signal are only detected if they are constantly pending longer than the set input delay time.

Hardware interrupt

Specifies whether or not a hardware interrupt is disabled or with which of the following events a hardware interrupt is generated.

- Rising edge
- Falling edge
- Rising and falling edge

4.1.3 Parameters of the Counting mode

Parameters of the DI 32x24VDC HF Count in the Counting mode

If you want to use the module for counting, you need to set the module parameters as DI 32x24VDC HF Count. For channels 0 and channel 1, the following parameter settings are then possible. For channels 2 to 31, the parameter settings apply as with the DI 32x24VDC HF, , see section Parameters DI mode (Page 20).

Table 4- 2 Settable parameters and their defaults in the Counting mode

Parameter	Range of values	Default setting	Parameter reassignment in RUN	Range of effectiveness with configuration software, e.g. STEP 7	
				Integrated in the hardware catalog as of STEP 7, V13 SP1 with HSP 0118 or GSD file PROFINET IO	GSD file PROFIBUS DP
Diagnostics					
• No supply voltage L+	Yes/No	No	Yes	Channel*	---
• Wire break	Yes/No	No	Yes	Channel	---
Input delay	0.05 ms, 0.1 ms, 0.4 ms, 1.6 ms, 3.2 ms, 12.8 ms, 20 ms	3.2 ms; for isochronous mode 0.05 ms (cannot be changed)	Yes	Channel	---
Hardware interrupt	<ul style="list-style-type: none"> • Disable • Comparison event occurred for DQ 	Disable	Yes	Channel	---
Set output DQ	<ul style="list-style-type: none"> • Between a comparison value and the high counting limit • Between a comparison value and the low counting limit 	Between a comparison value and the high counting limit	Yes	Channel	---

Parameter	Range of values	Default setting	Parameter reassign-	Range of effectiveness with configuration software, e.g. STEP 7	
Edge selection	<ul style="list-style-type: none"> On rising edge On falling edge On rising and falling edge 	On rising edge	Yes	Channel	---
High counting limit	0 ... 4294967295	4294967295	Yes	Channel	---
Comparison value	0 ... 4294967295**	1	Yes	Channel	---
Start value	0 ... 4294967295**	0	Yes	Channel	---
Behavior when a counting limit is exceeded	<ul style="list-style-type: none"> Stop counting Continue counting 	Stop counting	Yes	Channel	---

* If you enable diagnostics for multiple channels, you will receive an alarm storm on failure of the supply voltage because each enabled channel will detect this fault.

You can prevent this message burst by enabling diagnostics for one channel only.

** Comparison value or start value must be less than or equal to the value for the high counting limit.

4.1.4 Explanation of the parameters of the Counting mode

Missing supply voltage L+

Enabling of the diagnostics, with missing or too little supply voltage L+.

Wire break

Enabling diagnostics if the line to the encoder is interrupted.

Input delay

This parameter can be used to suppress signal disruptions. Changes to the signal are only detected if they are constantly pending longer than the set input delay time.

Hardware interrupt

Specifies whether or not a hardware interrupt is generated by the event "Comparison event occurred for DQ" (rising edge at STS_DQ).

4.1 Parameter

Set output DQ

With this parameter, you specify the behavior of the STS_DQ bit in the feedback interface. You can assign this bit in the user program, for example, with a hardware output, see Address space Counting mode (Page 30).

Behavior	Meaning
Between a comparison value and the high counting limit	STS_DQ bit is set if the following condition is met: Comparison value \leq counted value \leq high counting limit
Between a comparison value and the low counting limit	STS_DQ bit is set if the following condition is met: Low counting limit \leq counted value \leq comparison value

Edge selection

With this parameter you specify which edge is used to count.

You can select the following options:

- On rising edge
- On falling edge
- On rising and falling edge

High counting limit

With this parameter you limit the counting range. You can enter a value up to 4294967295 ($2^{32} - 1$).

Comparison value

With this parameter you specify the count value at which the digital output DQ (STS_DQ bit of the feedback interface) switches due to the selected comparison event.

Start value

With this parameter, you specify the value at which counting begins and is continued if defined events occur. The following condition must be met:

Low counting limit \leq start value \leq high counting limit.

Behavior when a counting limit is exceeded

With this parameter, you specify the behavior if a counting limit is exceeded.

Behavior	Meaning
Stop counting	After a counting limit is exceeded, the counting procedure is aborted and the STS_GATE bit (internal gate) is reset. To restart the counting, the SW_GATE bit must be reset via the control interface and set again.
Continue counting	After a counting limit is exceeded, the counted value is set to the other counting limit and counting is continued.

4.2 Address space

The module can be configured differently in STEP 7; see following table. Depending on the configuration, additional/different addresses are assigned in the process image of the inputs.

The letters "a to d" are printed onto the module. "EB a" for example, stands for module start address input byte a.

Configuration options of DI 32x24VDC HF

You can configure the module with STEP 7 (TIA Portal) or with a GSD file.

When you configure the module by means of the GSD file, the configurations are available under different abbreviations/module names.

The following configurations are possible:

Table 4-3 Configuration options

Configuration	Short designation/ module name in the GSD file	Configuration software, e.g., with STEP 7 (TIA Portal)	
		Integrated in hard- ware catalog STEP 7 (TIA Portal)	GSD file in STEP 7 (TIA Portal) V12 or higher or STEP 7 V5.5 SP3 or higher
1 x 32-channel without value status	DI 32x24VDC HF	V12 or higher	X
1 x 32-channel with value status	DI 32x24VDC HF QI	V12 or higher	X
4 x 8-channel without value status	DI 32x24VDC HF S	V13 update 3 or higher (PROFINET IO only)	X (PROFINET IO only)
4 x 8-channel with value status	DI 32x24VDC HF S QI	V13 update 3 or higher (PROFINET IO only)	X (PROFINET IO only)
1 x 32-channel with value status for module-internal Shared Input with up to 4 submodules	DI 32x24VDC HF MSI	V13 update 3 or higher (PROFINET IO only)	X (PROFINET IO only)
1 x 32 channel with value status (channel 0 and channel 1 for counting, channels 2 to 31 as digital inputs).	DI 32x24VDC HF Count	V13, SP1 with HSP 0118 or higher	X (PROFINET IO only)

Address space for configuration as 4 x 8-channel DI 32x24VDC HF S QI

For the configuration as a 4 x 8-channel module, the channels of the module are divided into four submodules. The submodules can be assigned to different IO controllers when the module is used in a shared device.

The number of I/O controllers depends on the interface module being used. Observe the information in the manual for the particular interface module.

Contrary to the 1 x 32-channel module configuration, each of the four submodules has a freely assignable start address.

Assignment in the process image input (PII)

	7	6	5	4	3	2	1	0	Input value:	
IB a	<input type="checkbox"/>	<input type="checkbox"/>	<input type="checkbox"/>	<input type="checkbox"/>	<input type="checkbox"/>	<input type="checkbox"/>	<input type="checkbox"/>	<input type="checkbox"/>	Channels 0 to 7 (inputs CH0 to CH7)	1st submodule
	15						8			
IB b	<input type="checkbox"/>	<input type="checkbox"/>	<input type="checkbox"/>	<input type="checkbox"/>	<input type="checkbox"/>	<input type="checkbox"/>	<input type="checkbox"/>	<input type="checkbox"/>	Channels 8 to 15 (inputs CH8 to CH15)	2nd submodule
	23						16			
IB c	<input type="checkbox"/>	<input type="checkbox"/>	<input type="checkbox"/>	<input type="checkbox"/>	<input type="checkbox"/>	<input type="checkbox"/>	<input type="checkbox"/>	<input type="checkbox"/>	Channels 16 to 23 (inputs CH16 to CH23)	3rd submodule
	31						24			
IB d	<input type="checkbox"/>	<input type="checkbox"/>	<input type="checkbox"/>	<input type="checkbox"/>	<input type="checkbox"/>	<input type="checkbox"/>	<input type="checkbox"/>	<input type="checkbox"/>	Channels 24 to 31 (inputs CH24 to CH31)	4th submodule

	7	6	5	4	3	2	1	0	(QI) Value status	
IB (=a+1)	<input type="checkbox"/>	<input type="checkbox"/>	<input type="checkbox"/>	<input type="checkbox"/>	<input type="checkbox"/>	<input type="checkbox"/>	<input type="checkbox"/>	<input type="checkbox"/>	Channels 0 to 7 (value status QI0 to QI7)	1st submodule
	15						8			
IB (=b+1)	<input type="checkbox"/>	<input type="checkbox"/>	<input type="checkbox"/>	<input type="checkbox"/>	<input type="checkbox"/>	<input type="checkbox"/>	<input type="checkbox"/>	<input type="checkbox"/>	Channels 8 to 16 (value status QI8 to QI15)	2nd submodule
	23						16			
IB (=c+1)	<input type="checkbox"/>	<input type="checkbox"/>	<input type="checkbox"/>	<input type="checkbox"/>	<input type="checkbox"/>	<input type="checkbox"/>	<input type="checkbox"/>	<input type="checkbox"/>	Channels 16 to 23 (value status QI16 to QI23)	3rd submodule
	31						24			
IB (=d+1)	<input type="checkbox"/>	<input type="checkbox"/>	<input type="checkbox"/>	<input type="checkbox"/>	<input type="checkbox"/>	<input type="checkbox"/>	<input type="checkbox"/>	<input type="checkbox"/>	Channels 24 to 31 (value status QI24 to QI31)	4th submodule

0 = Read-in value for the channel is invalid

Figure 4-2 Address space for configuration as 4 x 8-channel DI 32x24VDC HF S QI

Address space for configuration as 1 x 32-channel DI 32x24VDC HF MSI

The channels 0 to 31 of the module are copied in up to four submodules with configuration 1 x 32-channel module (Module-internal shared input, MSI). Channels 0 to 31 are then available with identical input values in different submodules. These submodules can be assigned to up to four IO controllers when the module is used in a shared device. Each IO controller has read access to the same channels.

The number of I/O controllers depends on the interface module being used. Please observe the information in the manual for the particular interface module.

4.2 Address space

Value status (Quality Information, QI)

The meaning of the value status depends on the submodule on which it occurs.

For the first submodule (=basic submodule), the value status 0 indicates that the value is incorrect.

For the 2nd to 4th submodule (=MSI submodule), the value status 0 indicates that the value is incorrect or the basic submodule has not yet been configured (not ready).

The following figure shows the assignment of the address space with submodules 1 and 2 and the value status.

Assignment in the process image input (PII) for 1st and 2nd submodule

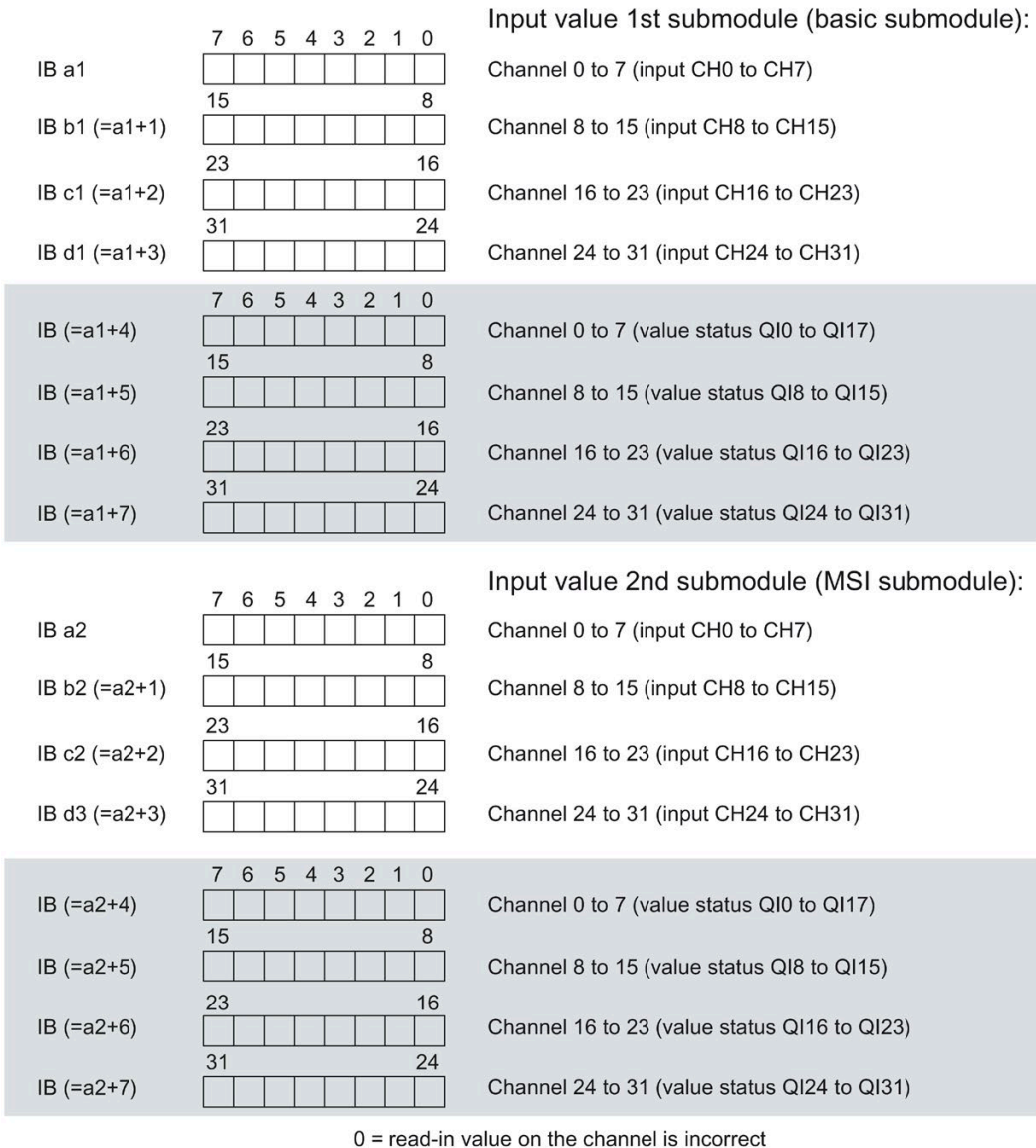

Figure 4-3 Address space for configuration as 1 x 32-channel DI 32x24VDC HF MSI with value status

The following figure shows the assignment of the address space with submodules 3 and 4 and the value status.

Assignment in the process image input (PII) for 3rd and 4th submodule

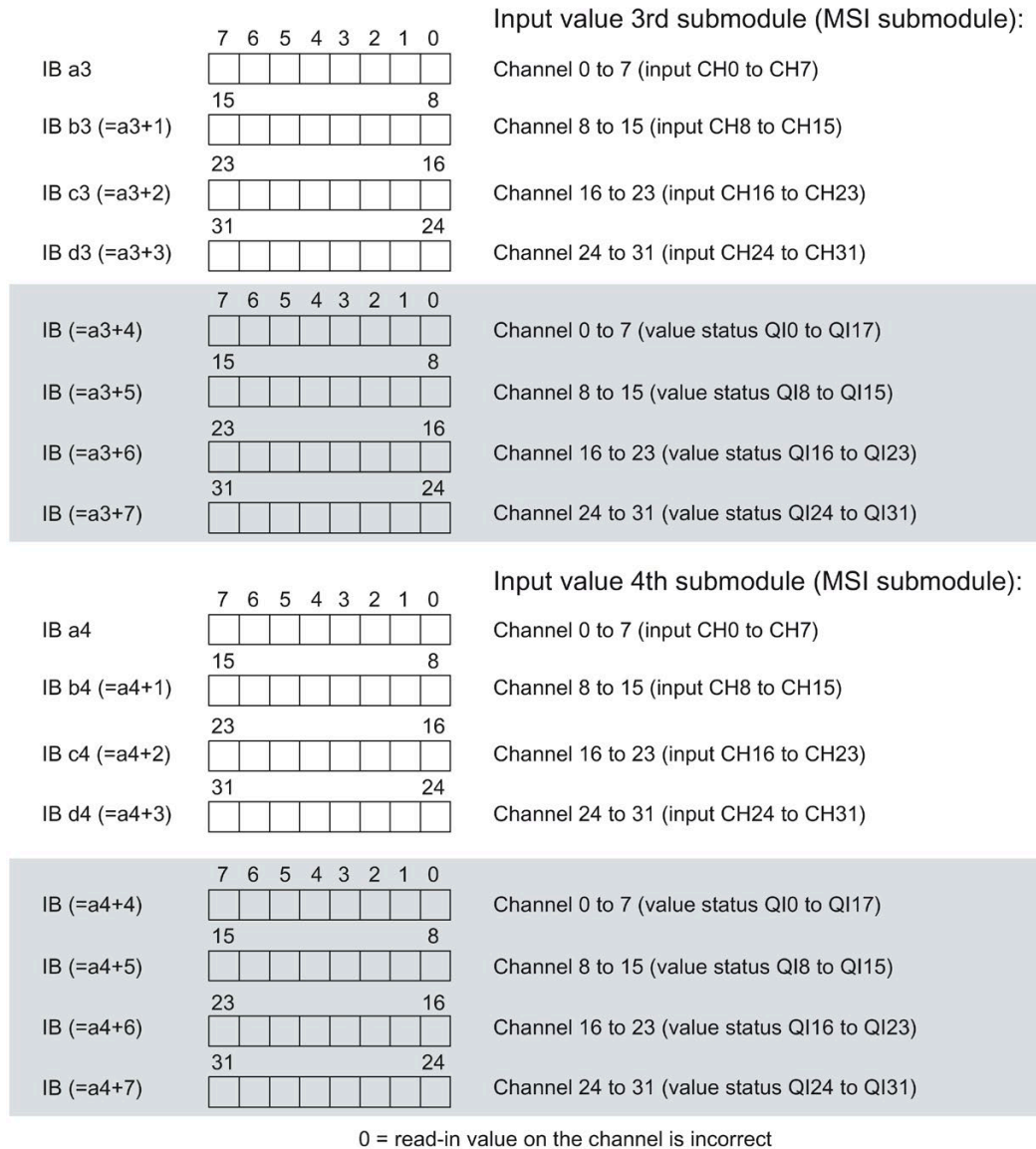

Figure 4-4 Address space for configuration as 1 x 32-channel DI 32x24VDC HF MSI with value status

Reference

You can find information on the module-internal shared input/shared output (MSI/MSO) function in the section Module-internal shared input/shared output (MSI/MSO) of the function manual PROFINET with STEP 7 V15

(<http://support.automation.siemens.com/WW/view/en/49948856>).

4.2.2 Address space Counting mode

Address space for configuration as 1 x 32-channel DI 32x24VDC Count

The address space of channel 0 and channel 1 used for counting consists of the control and feedback interface. The Count function is controlled directly via the two interfaces. With suitable parameter assignment, a hardware interrupt is triggered.

If you use the module in the "Counting mode" (channels 0 and 1), the module occupies the following address areas:

- 16 bytes in the process image output (control interface).
- 24 bytes in the process image input (feedback interface).

Control interface

The following figure shows the address assignment of the module in the process image output. You use the control interface for example to start the counter or to set the counter value. With the "SW gate" control bit you open and close the software gate of the corresponding channel.

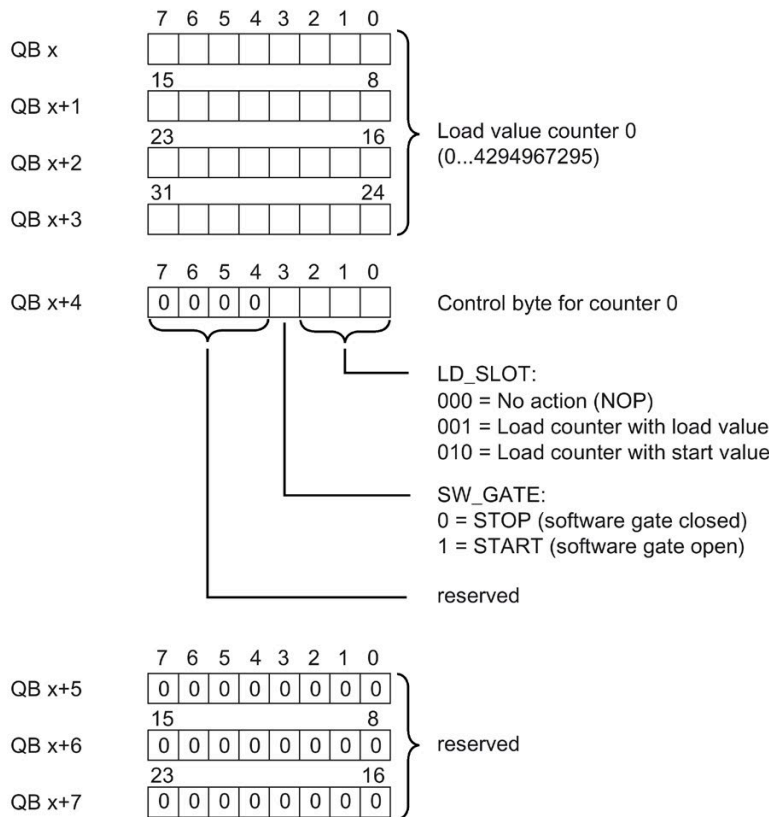

Figure 4-5 Assignment of the address space of the control interface of the DI 32x24VDC Count (bytes 0 to 7)

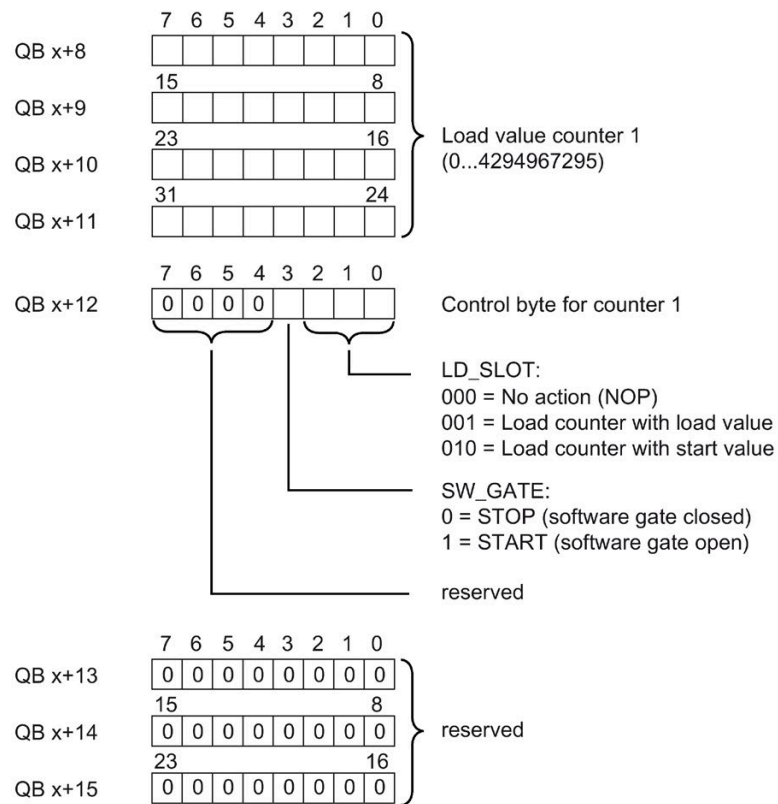

Figure 4-6 Assignment of the address space of the control interface of the DI 32x24VDC Count (bytes 8 to 15)

4.2 Address space

Feedback interface

The following figure shows the address assignment of the module in the process image input. The feedback interface for the counters (channels 0 and 1) begins at input byte x+8.

Via the feedback interface, the user program receives current counted values and status information from the module.

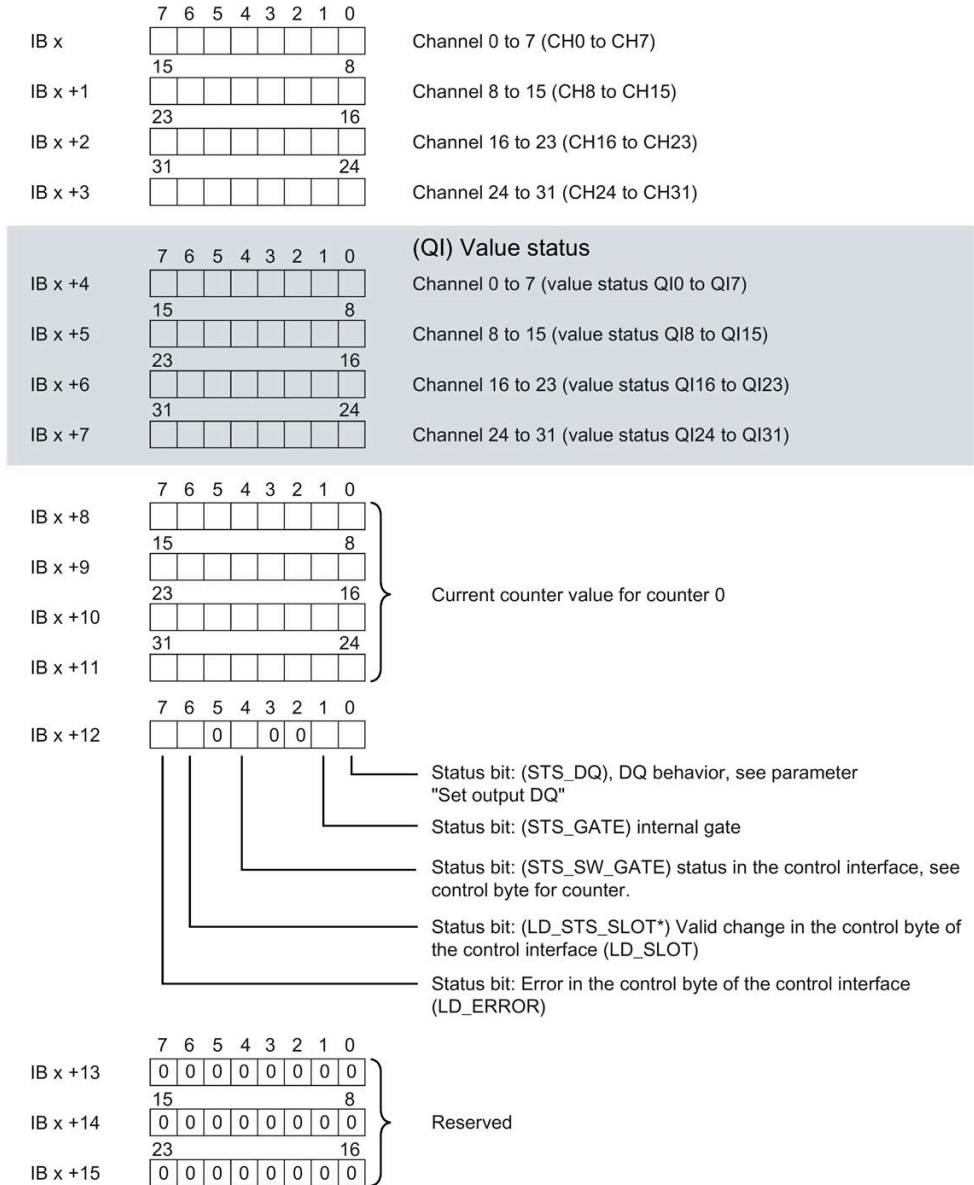

* "Acknowledgment bit" for bits 0 to 2 in the control interface (LD_SLOT). This bit changes its status when a new valid command is entered in LD_SLOT.

Figure 4-7 Assignment of the address space of the feedback interface of the DI 32x24VDC Count (bytes 0 to 15)

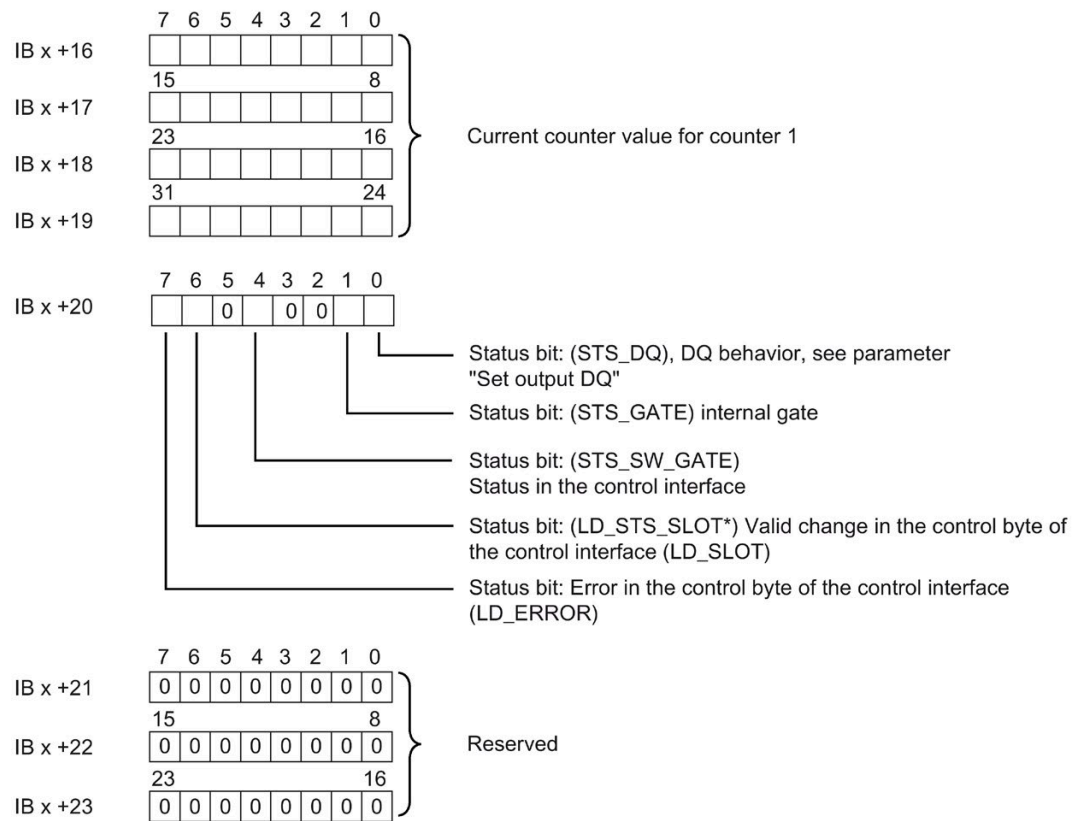

* "Acknowledgment bit" for bits 0 to 2 in the control interface (LD_SLOT). This bit changes its status when a new valid command is entered in LD_SLOT.

Figure 4-8 Assignment of the address space of the feedback interface of the DI 32x24VDC Count (bytes 16 to 23)

4.2.3 Examples of counting

In this section, you will find examples of the behavior of the counter and how you can specify this behavior. You specify the properties of the counter in the parameter assignment.

Behavior when a counting limit is exceeded - Stop counting

The following section describes the effects of the parameter "Behavior when a counting limit is exceeded = Stop counting". To control the counter, the bits of the control byte of the control interface are used, see section Address space Counting mode (Page 30)

Counting begins at the current counted value (the SW_GATE is set in the control byte). Bit sequence in the control byte of the control interface 0000 1000.

After the high counting limit is violated, counting is aborted (counting stops) and the counted value jumps to the low counting limit = 0. The STS_GATE bit is reset.

To restart the counting, the SW_GATE bit must be reset via the control interface and set again.

Whether or not counting is started again with the current counter value or with the start value depends on the command byte in the control interface.

Bit sequence in control byte of the control interface:

- bit 0 to 2 = "000" Start with current counter value
- bit 0 to 2 = "010" Start with start value

If the SW_GATE bit is reset in the control byte of the control interface before reaching the high counting limit, counting is stopped.

The following figure shows an example of the principle of stopping counting when a counting limit is exceeded.

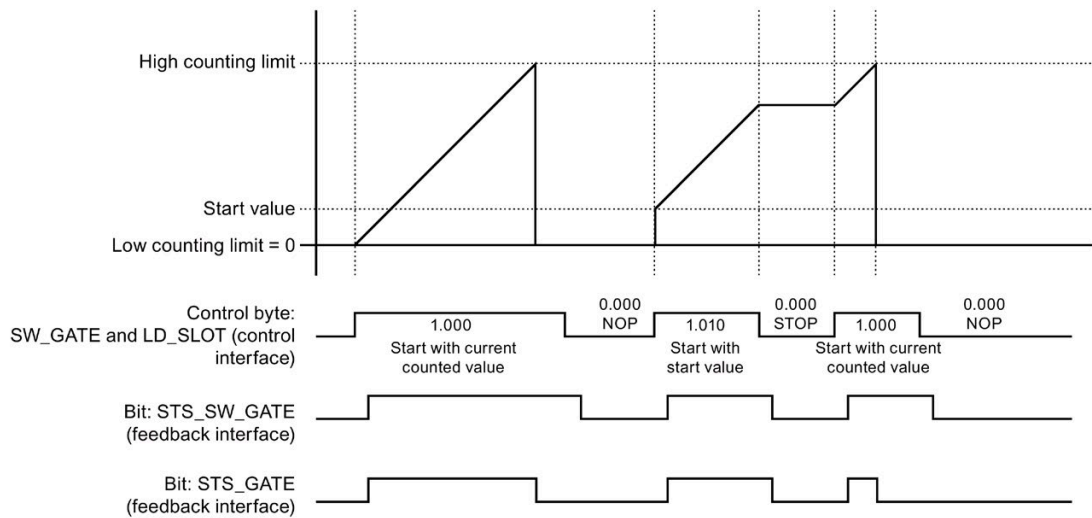

Figure 4-9 Principle: Stop counting

Behavior when a counting limit is exceeded - Continue counting

The following section describes the effects of the parameter "Behavior when a counting limit is exceeded = Continue counting". To control the counter, the bits of the control byte of the control interface are used, see section Address space Counting mode (Page 30), subsection Control interface.

Counting begins at the current counted value (the SW-GATE is set in the control byte). Bit sequence in the control byte of the control interface 0000 1000.

After the high counting limit is exceeded, the counted value jumps to the low counting limit = 0 and counting is continued.

If the SW_GATE bit is reset in the control byte of the control interface before reaching the high counting limit, counting is stopped.

The following figure shows an example of the principle of continuing counting when a counting limit is exceeded.

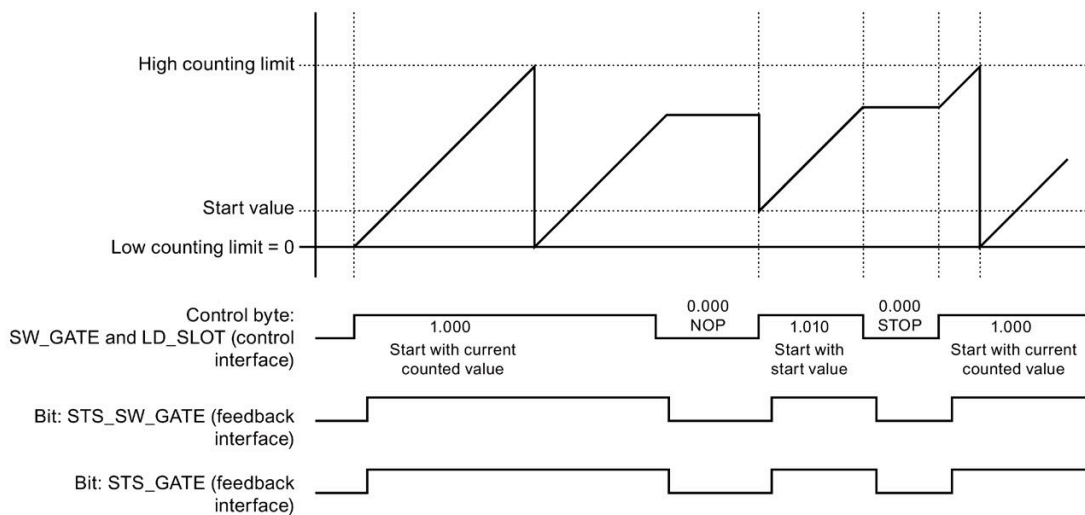

Figure 4-10 Principle: Continue counting

Set output DQ - behavior of the STS_DQ bit

The following section shows the behavior of the STS_DQ bit with the parameter assignment "Set output DQ = between comparison value and high counting limit".

The STS_DQ bit is set to 1

when the comparison value \leq counted value \leq high counting limit is reached.

As an option, a hardware interrupt can be enabled in the parameter assignment. This is generated with the parameter rising edge of the STS_DQ bit.

The following figure shows an example of the behavior of the STS_DQ bit between the comparison value and high counting limit.

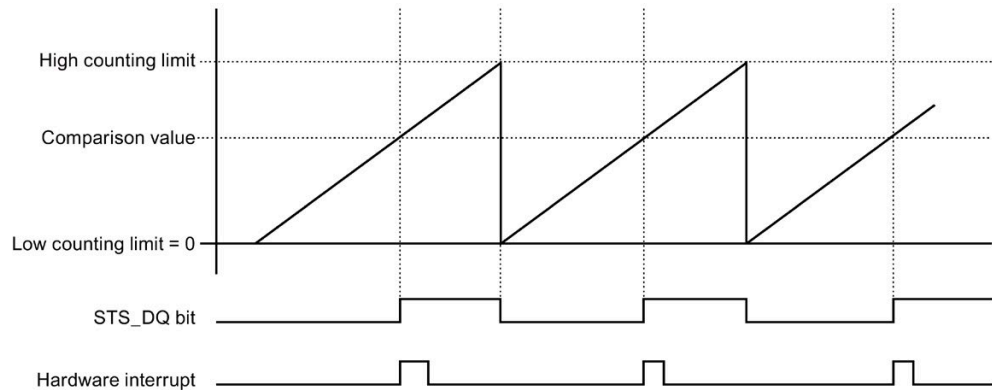

Figure 4-11 Behavior of the STS_DQ bit and hardware interrupt

The following section shows the behavior of the STS_DQ bit with the parameter assignment "Set output DQ = between low counting limit and comparison value".

The STS_DQ bit is set to 1

when the low counting limit \leq counted value \leq comparison value is reached.

As an option, a hardware interrupt can be enabled in the parameter assignment. This is generated with the parameter rising edge of the STS_DQ bit.

The following figure shows an example of the behavior of the STS_DQ bit between the low counting limit and comparison value.

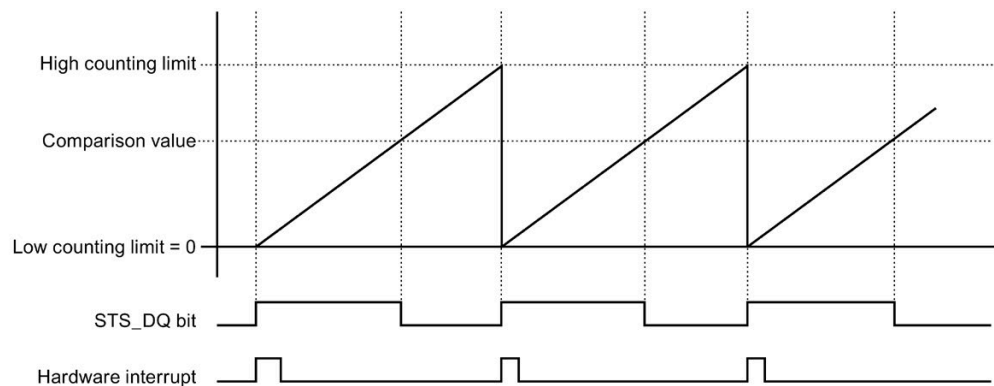

Figure 4-12 Behavior of the STS_DQ bit and hardware interrupt

Counting limits

The counting limits define the range of values of the counted value used. The counting limits can be set in the parameters and can be changed with the user program during runtime.

Configurable high counting limit: 4294967295 ($2^{32} - 1$).

Low counting limit (not settable): 0

You can continue or terminate (automatic gate stop) counting if a counting limit is exceeded, see the parameter "Behavior when a counting limit is exceeded".

Start value/load value

The start value is specified in the parameter assignment with STEP 7 (TIA Portal). The load value can be changed by the user program. Both values must be between the low counting limit and high counting limit.

Comparison values

You specify a comparison value per channel that can control the feedback bit STS_DQ regardless of the user program. When the current counted value corresponds to the comparison condition set in the parameters, the feedback bit STS_DQ is set. You can use the feedback bit STS_DQ to control a digital output of a digital output module.

The comparison values can be set in the parameters and can be changed during runtime via the user program with parameter data record 0/1.

4.2 Address space

Gate control

The opening and closing of the software gate (SW-GATE) defines the time window in which the count signals are acquired. The software gate is controlled by the user program.

Reference

You can find additional information on the counting functionality in the function manual S7-1500, ET 200MP, ET 200SP counting, measuring and position detection (<http://support.automation.siemens.com/WW/view/en/59709820>).

Interrupts/diagnostics alarms

5.1 Status and error displays

LED displays

The following figure shows you the LED displays (status and error displays) of DI 32x24VDC HF.

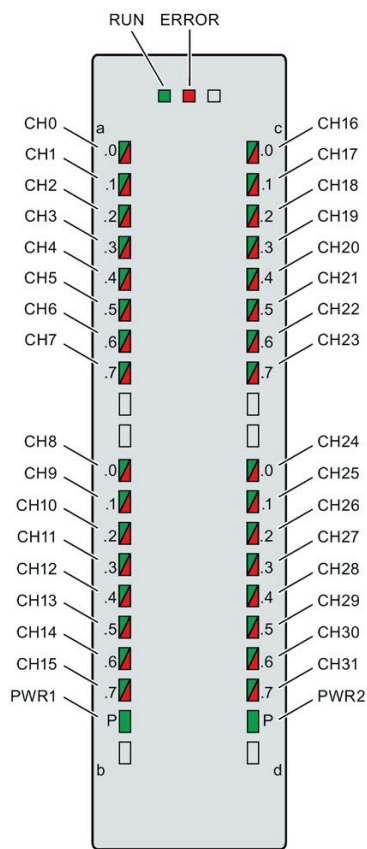

Figure 5-1 LED displays of the module DI 32x24VDC HF

Meaning of the LED displays

The following tables explain the meaning of the status and error displays. Remedial measures for diagnostic reports can be found in chapter Diagnostics alarms (Page 43).

RUN and ERROR LED

Table 5- 1 Status and error displays RUN and ERROR

LED		Meaning	Remedy
RUN	ERROR		
□ Off	□ Off	Voltage missing or too low at backplane bus	<ul style="list-style-type: none"> Switch on the CPU and/or the system power supply modules. Verify that the U connectors are inserted. Check to see if too many modules are inserted.
☀ Flashes	□ Off	The module starts and flashes until the valid parameter assignment is set.	---
■ On	□ Off	Module is configured	---
■ On	☀ Flashes	Indicates module errors (at least one error at one channel, e.g., wire break).	Evaluate the diagnostics data and eliminate the error (e.g., wire break).
☀ Flashes	☀ Flashes	Hardware defective	Replace the module.

PWR1 and PWR2 LED

Table 5- 2 PWR1 and PWR2 status indication

LED PWR1 / PWR2	Meaning	Remedy
□ Off	Supply voltage L+ too low or missing	Check supply voltage L+.
■ On	Supply voltage L+ is present and OK	---

CHx LED

Table 5- 3 CHx status display

LED CHx	Meaning	Remedy
□ Off	0 = Status of the input signal	---
■ On	1 = Status of the input signal	---
■ On	Diagnostics: Wire break	Check the wiring. When using simple switches, deactivate diagnostics or connect a resistor (25 kΩ ... 45 kΩ) to the encoder contacts.
	Supply voltage L+ too low or missing	Check supply voltage L+

5.2 Interrupts

Digital input module DI 32x24VDC HF supports diagnostic and hardware interrupts.

You can find detailed information on the error event in the error organization block with the "RALRM" instruction (read additional interrupt info) and in the STEP 7 online help.

Diagnostics interrupt

The module generates a diagnostic interrupt at the following events:

- Missing supply voltage L+
- Wire break
- Parameter assignment error

Hardware interrupt

The module generates a hardware interrupt at the following events:

- Rising edge
- Falling edge
- Rising and falling edge
- Comparison event occurred for DQ (only in "Counting mode")

The module channel that triggered the hardware interrupt is entered in the start information of the organization block. The figure below shows the assignment to the bits of the local data double word 8.

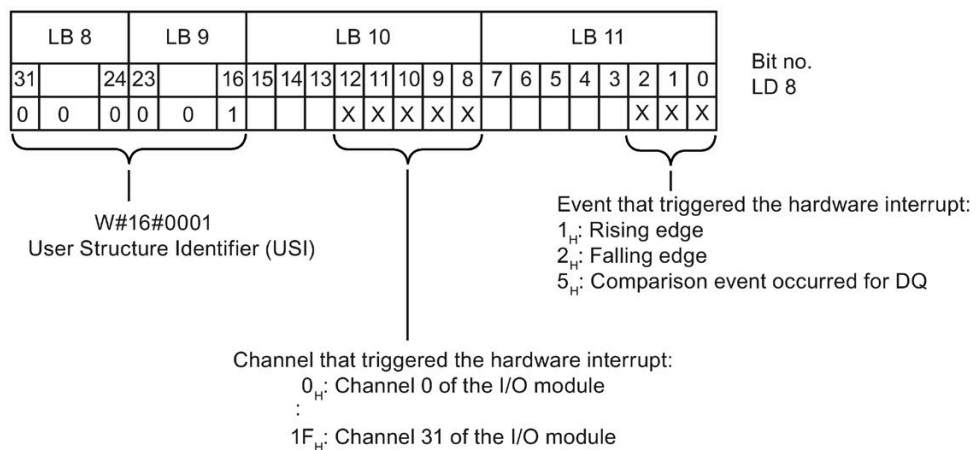

Figure 5-2 Start information of the organization block

Structure of the additional interrupt information

Table 5- 4 Structure of USI = W#16#0001

Data block name	Contents	Comment	Bytes
USI (User Structure Identifier)	W#16#0001	Additional interrupt info for hardware interrupts of the I/O module	2
The channel that triggered the hardware interrupt follows.			
Channel	B#16#00 to B#16#1F	Number of the event-triggering channel (channel 0 to channel 31 of the module)	1
It follows the error event that triggered the hardware interrupt.			
Event	B#16#01	Rising edge	1
	B#16#02	Falling edge	
	B#16#05	Comparison event occurred for DQ (only in "Counting mode")	

5.3 Diagnostics alarms

Diagnostics alarms

A diagnostics alarm is generated and the ERROR-LED flashes for each diagnostics event on the module. The diagnostics alarms can, for example, be read out in the diagnostics buffer of the CPU. You can evaluate the error codes with the user program.

If the module is operated distributed with PROFIBUS DP in an ET 200MP system, you have the option to read out diagnostics data with the instruction RDREC or RD_REC using data record 0 and 1. The structure of the data records is available on the Internet in the "Manual for interface module IM 155-5 DP ST (6ES7155-5BA00-0AB0)".

Table 5- 5 Diagnostics alarms, their meaning and corrective measures

Diagnostics alarm	Error code	Meaning	Corrective measures
Wire break*	6H	Impedance of encoder circuit too high	Use a different encoder type or modify the wiring, for example, using cables with larger cross-section
		Wire break between the module and sensor	Connect the cable
		Channel not connected (open)	<ul style="list-style-type: none"> Disable diagnostics Connect a resistor of 25 kΩ to 45 kΩ to the encoder contacts
Parameter assignment error	10H	<ul style="list-style-type: none"> The module cannot evaluate parameters for the channel Incorrect parameter assignment 	Correct the parameter assignment
Load voltage missing	11H	Supply voltage L+ of the module is missing	Connect supply voltage L+ to module/channel
Hardware interrupt lost	16H	The module cannot trigger an interrupt because the previous interrupt was not acknowledged; possibly a configuration error	<ul style="list-style-type: none"> Change interrupt processing in the CPU and, if necessary, edit the module parameters. The error persists until the module is assigned new parameters

* If the supply voltage fails in case of a pending wire break diagnostics, the value status momentarily indicates an incorrect value.

Technical specifications

Technical specifications of the DI 32x24VDC HF

The following table shows the technical specifications as of 05/2022. You will find a data sheet including daily updated technical specifications on the Internet (<https://support.industry.siemens.com/cs/ww/en/pv/6ES7521-1BL00-0AB0/td?dl=en>).

Article number	6ES7521-1BL00-0AB0
General information	
Product type designation	DI 32x24VDC HF
HW functional status	from FS04
Firmware version	V2.2.1
<ul style="list-style-type: none"> FW update possible 	Yes
Product function	
<ul style="list-style-type: none"> I&M data 	Yes; I&M0 to I&M3
<ul style="list-style-type: none"> Isochronous mode 	Yes
<ul style="list-style-type: none"> Prioritized startup 	Yes
Engineering with	
<ul style="list-style-type: none"> STEP 7 TIA Portal configurable/integrated from version 	V13 SP1 / -
<ul style="list-style-type: none"> STEP 7 configurable/integrated from version 	V5.5 SP3 / -
<ul style="list-style-type: none"> PROFIBUS from GSD version/GSD revision 	V1.0 / V5.1
<ul style="list-style-type: none"> PROFINET from GSD version/GSD revision 	V2.3 / -
Operating mode	
<ul style="list-style-type: none"> DI 	Yes
<ul style="list-style-type: none"> Counter 	Yes
<ul style="list-style-type: none"> Oversampling 	No
<ul style="list-style-type: none"> MSI 	Yes
Supply voltage	
Rated value (DC)	24 V
permissible range, lower limit (DC)	19.2 V
permissible range, upper limit (DC)	28.8 V
Reverse polarity protection	Yes
Input current	
Current consumption, max.	40 mA; 20 mA per group with 24 V DC supply
Power	
Power available from the backplane bus	1.1 W
Power loss	
Power loss, typ.	4.2 W

Article number	6ES7521-1BL00-0AB0
Digital inputs	
Number of digital inputs	32
Digital inputs, parameterizable	Yes
Source/sink input	P-reading
Input characteristic curve in accordance with IEC 61131, type 3	Yes
Digital input functions, parameterizable	
• Gate start/stop	Yes
• Freely usable digital input	Yes
• Counter	
– Number, max.	2
– Counting frequency, max.	6 kHz; FS04 and FW V2.2.1 or higher
– Counting width	32 bit
– Counting direction up/down	Up
Input voltage	
• Rated value (DC)	24 V
• for signal "0"	-30 to +5 V
• for signal "1"	+11 to +30V
Input current	
• for signal "1", typ.	2.5 mA
Input delay (for rated value of input voltage) for standard inputs	
– parameterizable	Yes; 0.05 / 0.1 / 0.4 / 1.6 / 3.2 / 12.8 / 20 ms
– at "0" to "1", min.	0.05 ms
– at "0" to "1", max.	20 ms
– at "1" to "0", min.	0.05 ms
– at "1" to "0", max.	20 ms
for interrupt inputs	
– parameterizable	Yes
for technological functions	
– parameterizable	Yes
Cable length	
• shielded, max.	1 000 m
• unshielded, max.	600 m
Encoder	
Connectable encoders	
• 2-wire sensor	Yes
– permissible quiescent current (2-wire sensor), max.	1.5 mA

Article number	6ES7521-1BL00-0AB0
Isochronous mode	
Filtering and processing time (TCI), min.	80 µs; At 50 µs filter time
Bus cycle time (TDP), min.	250 µs
Interrupts/diagnostics/status information	
Diagnostics function	Yes
Alarms	
• Diagnostic alarm	Yes
• Hardware interrupt	Yes
Diagnoses	
• Monitoring the supply voltage	Yes
• Wire-break	Yes; to I < 350 µA
• Short-circuit	No
Diagnostics indication LED	
• RUN LED	Yes; green LED
• ERROR LED	Yes; red LED
• Monitoring of the supply voltage (PWR-LED)	Yes; green LED
• Channel status display	Yes; green LED
• for channel diagnostics	Yes; red LED
• for module diagnostics	Yes; red LED
Potential separation	
Potential separation channels	
• between the channels	Yes
• between the channels, in groups of	16
• between the channels and backplane bus	Yes
• between the channels and the power supply of the electronics	No
Isolation	
Isolation tested with	707 V DC (type test)
Standards, approvals, certificates	
Suitable for safety functions	No
Ambient conditions	
Ambient temperature during operation	
• horizontal installation, min.	-30 °C; From FS05
• horizontal installation, max.	60 °C
• vertical installation, min.	-30 °C; From FS05
• vertical installation, max.	40 °C
Altitude during operation relating to sea level	
• Installation altitude above sea level, max.	5 000 m; Restrictions for installation altitudes > 2 000 m, see manual

Article number	6ES7521-1BL00-0AB0
Dimensions	
Width	35 mm
Height	147 mm
Depth	129 mm
Weights	
Weight, approx.	260 g

Tolerances of the programmable input delay

Table 6- 1 Tolerances of the programmable input delay

Input delay	Tolerance range
0.05 ms	43 μ s to 57 μ s
0.1 ms	86 μ s to 114 μ s
0.4 ms	344 μ s to 456 μ s
1.6 ms	1.5 ms to 1.9 ms
3.2 ms (preset)	3 ms to 4 ms
12.8 ms	12 ms to 15 ms
20 ms	19 ms to 23 ms

Dimensional drawing

The dimensional drawing of the module on the mounting rail, as well as a dimensional drawing with open front cover, are provided in the appendix. Always observe the specified dimensions for installation in cabinets, control rooms, etc.

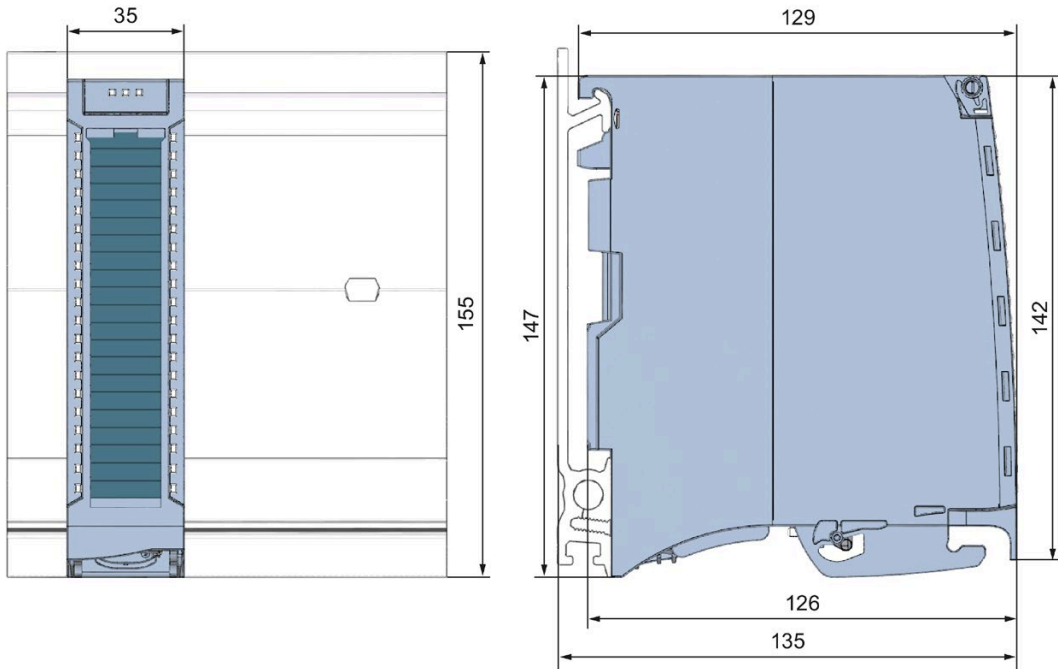

Figure A-1 Dimensional drawing of the DI 32x24VDC HF module

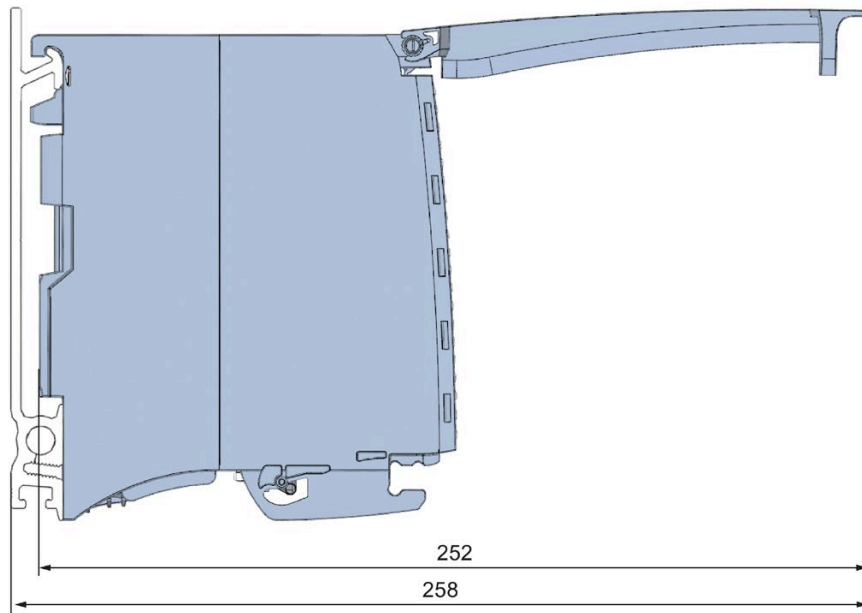

Figure A-2 Dimensional drawing of the DI 32x24VDC HF module, side view with open front cover

Parameter data records

B.1 Parameter assignment and structure of the parameter data records

The data records of the module have an identical structure, regardless of whether you configure the module with PROFIBUS DP or PROFINET IO.

Dependencies for configuration with GSD file

When configuring the module with a GSD file, remember that the settings of some parameters are dependent on each other. The parameters are only checked for plausibility by the module after the transfer to the module.

DI mode: no dependencies. You can assign the individual parameters in any combination.

Counting mode: The following table lists the parameters that depend on one another.

Table B- 1 Dependencies of parameters for configuration with GSD file

Device-specific parameters (GSD file)	Dependent parameters
Comparison value	0 ... high counting limit
Start value	0 ... high counting limit

Parameter assignment in the user program

You have the option to reconfigure the module in RUN (e.g. the input delay values of selected channels can be edited without having an effect on the other channels).

Parameter assignment in RUN

The WRREC instruction is used to transfer the parameters to the module using data records 0 to 31. The parameters set in STEP 7 do not change in the CPU, which means the parameters set in STEP 7 are still valid after a restart.

The parameters are only checked for plausibility by the module after the transfer.

Output parameter STATUS

The module ignores errors that occurred during the transfer of parameters with the WRREC instruction and continues operation with the previous parameter assignment. However, a corresponding error code is written to the STATUS output parameter.

The description of the WRREC instruction and the error codes is available in the STEP 7 online help.

Operation of the module behind a PROFIBUS DP interface module

If the module is operated behind a PROFIBUS DP interface module, the parameter data records 0 and 1 are not read back. You get the diagnostics data records 0 and 1 for the read back parameter data records 0 and 1. You can find more information in the Interrupts section of the PROFIBUS DP interface module device manual on the Internet (<http://support.automation.siemens.com/WW/view/en/78324181>).

B.2 Structure of the parameter data records DI mode

Assignment of data record and channel

For the configuration with 1 x 32 channels, the parameters are located in data records 0 to 31 and are assigned as follows:

- Data record 0 for channel 0
- Data record 1 for channel 1
- ...
- Data record 30 for channel 30
- Data record 31 for channel 31

For the configuration as a 4 x 8-channel module, the module has 4 submodules with eight channels each. The parameters for the channels are located in data records 0 to 7 and are assigned as follows:

- Data records 0 to 7 for channels 0 to 7 (submodule 1)
- Data records 0 to 7 for channels 8 to 15 (submodule 2)
- Data records 0 to 7 for channels 16 to 23 (submodule 3)
- Data records 0 to 7 for channels 24 to 31 (submodule 4)

Address the respective submodule for data record transfer.

Structure of a data record in the DI mode

The example in the following figure shows the structure of data record 0 for channel 0. The structure of channels 1 to 31 is identical. The values in byte 0 and byte 1 are fixed and may not be changed.

Enable a parameter by setting the corresponding bit to "1".

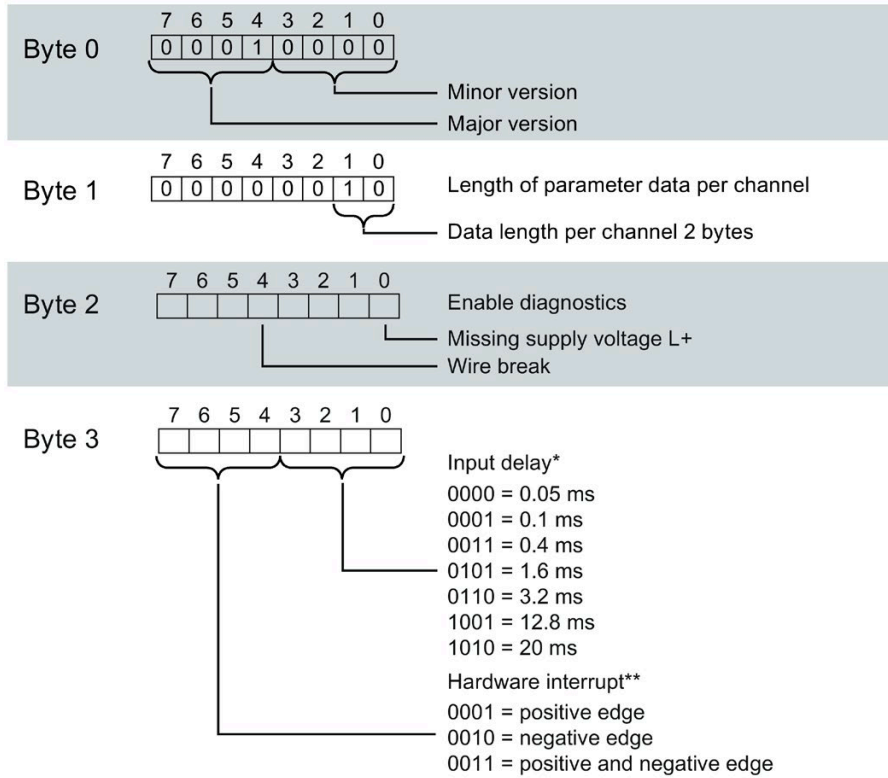

* For isochronous mode 0.05 ms (cannot be changed)

** Hardware interrupts can only be activated using the data record if a hardware interrupt OB is assigned to the channel in STEP 7

Figure B-1 Structure of data record 0: Bytes 0 to 3

B.3 Structure of the parameter data records Counting mode

Assignment of data record and channel

For the configuration with 1 x 32 channels, the parameters are located in data records 0 to 31 and are assigned as follows:

- Data record 0 for channel 0 with counting function
- Data record 1 for channel 1 with counting function
- Data record 2 for channel 2 (structure as in DI mode)
- ...
- Data record 30 for channel 30 (structure as in DI mode)
- Data record 31 for channel 31 (structure as in DI mode)

Structure of data record 0 of the Counting mode

The example in the figure below shows the structure of data record 0 for channel 0. The structure of channel 1 is identical, the values are located in data record 1.

The values in byte 0 and byte 1 are fixed and may not be changed.

Enable a parameter by setting the corresponding bit to "1".

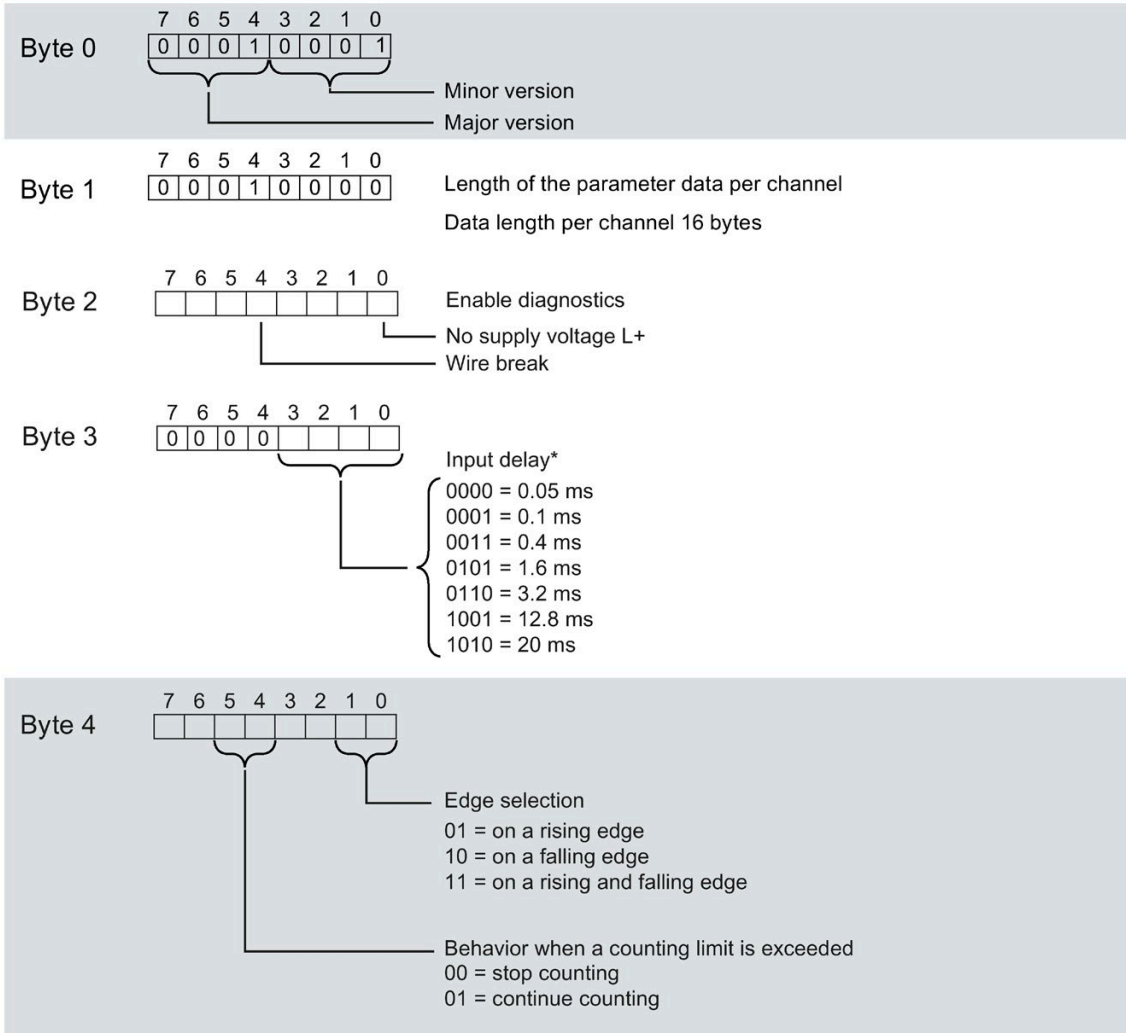

* In isochronous mode 0.05 ms (cannot be changed)

Figure B-2 Structure of data record 0: Bytes 0 to 4

B.3 Structure of the parameter data records Counting mode

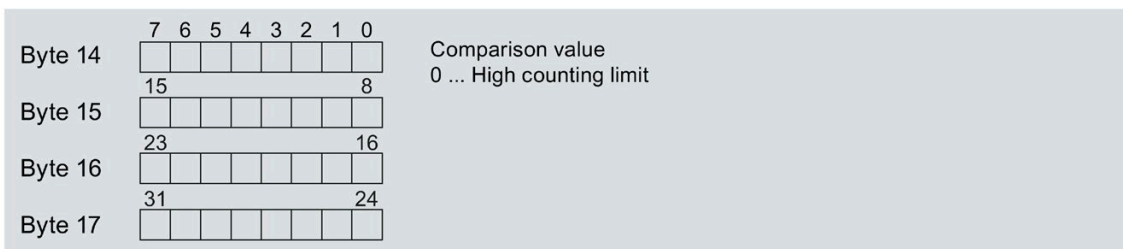
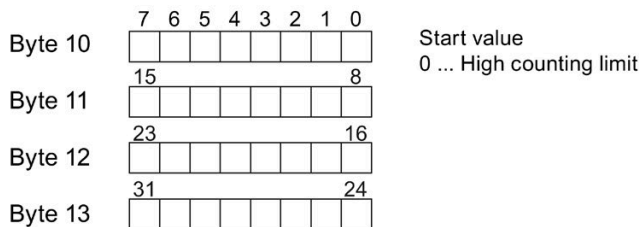
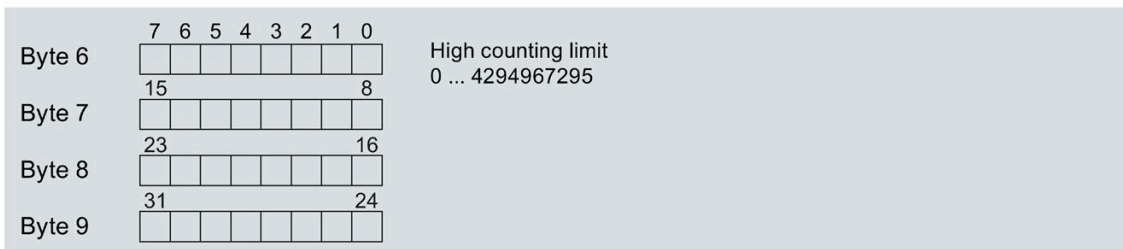
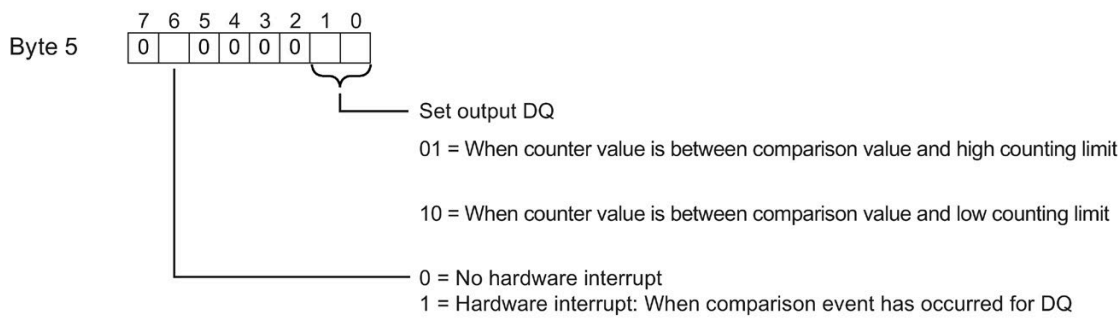

Figure B-3 Structure of data record 0: Bytes 5 to 17

Keep in mind that the counter is stopped and reset to the start value when you change count parameters.
 Changing the parameters "Diagnostics" and "Hardware interrupts" does not have an effect on the counter.

Structure of data records 2 to 31

The structure of data records 2 to 31 for channels 2 to 31 is identical to the structure in the DI mode, see section Structure of the parameter data records DI mode (Page 51), figure Structure of data record 0: Bytes 0 to 3.