

SIEMENS



Manual

SIMATIC

S7-1500 / ET 200MP

DQ 8x24VDC/2A HF
Digital Output Module (6ES7522-1BF00-0AB0)

Edition

06/2018

support.industry.siemens.com

SIEMENS

SIMATIC

S7-1500/ET 200MP DQ 8x24VDC/2A HF Digital Output Module (6ES7522-1BF00-0AB0)

Manual

Preface

Documentation guide

1

Product overview

2

Wiring

3

Parameters/address space

4

Interrupts/diagnostics alarms

5

Technical specifications

6

Dimensional drawing

A

Parameter data records

B



06/2018

A5E03485650-AF

Legal information

Warning notice system

This manual contains notices you have to observe in order to ensure your personal safety, as well as to prevent damage to property. The notices referring to your personal safety are highlighted in the manual by a safety alert symbol, notices referring only to property damage have no safety alert symbol. These notices shown below are graded according to the degree of danger.

 DANGER
indicates that death or severe personal injury will result if proper precautions are not taken.
 WARNING
indicates that death or severe personal injury may result if proper precautions are not taken.
 CAUTION
indicates that minor personal injury can result if proper precautions are not taken.
NOTICE
indicates that property damage can result if proper precautions are not taken.

If more than one degree of danger is present, the warning notice representing the highest degree of danger will be used. A notice warning of injury to persons with a safety alert symbol may also include a warning relating to property damage.

Qualified Personnel

The product/system described in this documentation may be operated only by **personnel qualified** for the specific task in accordance with the relevant documentation, in particular its warning notices and safety instructions. Qualified personnel are those who, based on their training and experience, are capable of identifying risks and avoiding potential hazards when working with these products/systems.

Proper use of Siemens products

Note the following:

 WARNING
Siemens products may only be used for the applications described in the catalog and in the relevant technical documentation. If products and components from other manufacturers are used, these must be recommended or approved by Siemens. Proper transport, storage, installation, assembly, commissioning, operation and maintenance are required to ensure that the products operate safely and without any problems. The permissible ambient conditions must be complied with. The information in the relevant documentation must be observed.

Trademarks

All names identified by ® are registered trademarks of Siemens AG. The remaining trademarks in this publication may be trademarks whose use by third parties for their own purposes could violate the rights of the owner.

Disclaimer of Liability

We have reviewed the contents of this publication to ensure consistency with the hardware and software described. Since variance cannot be precluded entirely, we cannot guarantee full consistency. However, the information in this publication is reviewed regularly and any necessary corrections are included in subsequent editions.

Preface

Purpose of the documentation

This manual supplements the system manual S7-1500/ET 200MP (<https://support.industry.siemens.com/cs/ww/en/view/59191792>).

Functions that relate in general to the systems are described in this system manual.

The information provided in this manual and in the system/function manuals supports you in commissioning the systems.

Changes compared to previous version

Compared to the previous version, this manual contains the following change:

- New licensing conditions and copyright information of the Open Source Software
- The module features a switching cycle counter as of firmware version V2.2.0.

Conventions

The term "CPU" is used in this manual both for the CPUs of the S7-1500 automation system, as well as for interface modules of the ET 200MP distributed I/O system.

Please also observe notes marked as follows:

Note

A note contains important information on the product described in the documentation, on the handling of the product or on the section of the documentation to which particular attention should be paid.

Recycling and disposal

For environmentally friendly recycling and disposal of your old equipment, contact a certified electronic waste disposal company and dispose of the equipment according to the applicable regulations in your country.

Security information

Siemens provides products and solutions with industrial security functions that support the secure operation of plants, systems, machines and networks.

In order to protect plants, systems, machines and networks against cyber threats, it is necessary to implement – and continuously maintain – a holistic, state-of-the-art industrial security concept. Siemens' products and solutions constitute one element of such a concept.

Customers are responsible for preventing unauthorized access to their plants, systems, machines and networks. Such systems, machines and components should only be connected to an enterprise network or the internet if and to the extent such a connection is necessary and only when appropriate security measures (e.g. firewalls and/or network segmentation) are in place.

For additional information on industrial security measures that may be implemented, please visit (<https://www.siemens.com/industrialsecurity>).

Siemens' products and solutions undergo continuous development to make them more secure. Siemens strongly recommends that product updates are applied as soon as they are available and that the latest product versions are used. Use of product versions that are no longer supported, and failure to apply the latest updates may increase customers' exposure to cyber threats.

To stay informed about product updates, subscribe to the Siemens Industrial Security RSS Feed under (<https://www.siemens.com/industrialsecurity>).

Open Source Software

Open-source software is used in the firmware of the I/O modules. Open Source Software is provided free of charge. We are liable for the product described, including the open-source software contained in it, pursuant to the conditions applicable to the product. Siemens accepts no liability for the use of the open source software over and above the intended program sequence, or for any faults caused by modifications to the software.

For legal reasons, we are obliged to publish the original text of the license conditions and copyright notices. Please read the information relating to this on the Internet (<https://support.industry.siemens.com/cs/ww/en/view/109757558>).

Table of contents

	Preface	3
1	Documentation guide	6
2	Product overview	10
	2.1 Properties.....	10
	2.2 Functions	13
	2.2.1 Pulse-width modulation (PWM)	13
	2.2.2 Switching cycle counter	17
3	Wiring	19
4	Parameters/address space	21
	4.1 Parameters	21
	4.1.1 DQ operating mode parameter	22
	4.1.2 Explanation of the parameters of DQ mode	23
	4.1.3 Pulse width modulation operating mode parameter	24
	4.1.4 Explanation of the parameters of pulse width modulation mode	25
	4.2 Address space	26
	4.2.1 Address space operating mode DQ.....	27
	4.2.2 Address space operating mode pulse-width modulation	29
5	Interrupts/diagnostics alarms.....	30
	5.1 Status and error displays	30
	5.2 Interrupts.....	32
	5.3 Diagnostics alarms.....	33
6	Technical specifications	34
A	Dimensional drawing.....	41
B	Parameter data records.....	43
	B.1 Parameter assignment.....	43
	B.2 Structure of parameter data sets DS 64 - 71	45
	B.3 Structure of data set DS 129	46
	B.4 Structure of data set DS 130	47
	B.5 Structure of data set DS 131	48

Documentation guide

The documentation for the SIMATIC S7-1500 automation system and the SIMATIC ET 200MP distributed I/O system is arranged into three areas. This arrangement enables you to access the specific content you require.

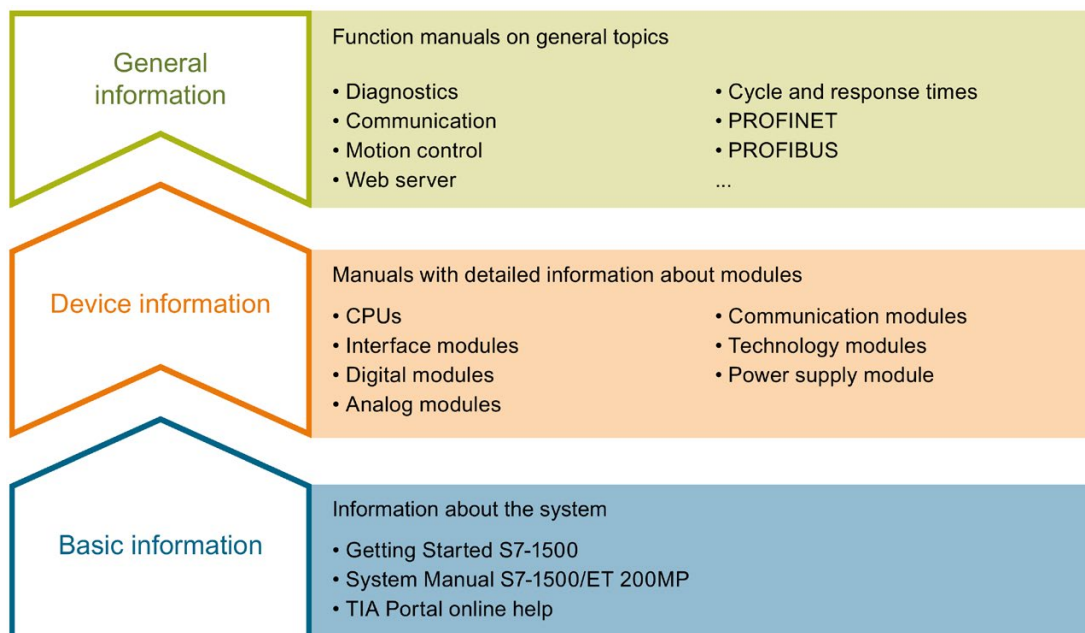

Basic information

The System Manual and Getting Started describe in detail the configuration, installation, wiring and commissioning of the SIMATIC S7-1500 and ET 200MP systems. The STEP 7 online help supports you in the configuration and programming.

Device information

Product manuals contain a compact description of the module-specific information, such as properties, wiring diagrams, characteristics and technical specifications.

General information

The function manuals contain detailed descriptions on general topics regarding the SIMATIC S7-1500 and ET 200MP systems, e.g. diagnostics, communication, motion control, Web server, OPC UA.

You can download the documentation free of charge from the Internet (<https://support.industry.siemens.com/cs/ww/en/view/109742691>).

Changes and supplements to the manuals are documented in a Product Information.

You can download the product information free of charge from the Internet (<https://support.industry.siemens.com/cs/us/en/view/68052815>).

Manual Collection S7-1500/ET 200MP

The Manual Collection contains the complete documentation on the SIMATIC S7-1500 automation system and the ET 200MP distributed I/O system gathered together in one file.

You can find the Manual Collection on the Internet (<https://support.industry.siemens.com/cs/ww/en/view/86140384>).

SIMATIC S7-1500 comparison list for programming languages

The comparison list contains an overview of which instructions and functions you can use for which controller families.

You can find the comparison list on the Internet (<https://support.industry.siemens.com/cs/ww/en/view/86630375>).

"mySupport"

With "mySupport", your personal workspace, you make the best out of your Industry Online Support.

In "mySupport", you can save filters, favorites and tags, request CAx data and compile your personal library in the Documentation area. In addition, your data is already filled out in support requests and you can get an overview of your current requests at any time.

You must register once to use the full functionality of "mySupport".

You can find "mySupport" on the Internet (<https://support.industry.siemens.com/My/ww/en>).

"mySupport" - Documentation

In the Documentation area in "mySupport" you can combine entire manuals or only parts of these to your own manual.

You can export the manual as PDF file or in a format that can be edited later.

You can find "mySupport" - Documentation on the Internet (<http://support.industry.siemens.com/My/ww/en/documentation>).

"mySupport" - CAx data

In the CAx data area in "mySupport", you can access the current product data for your CAx or CAe system.

You configure your own download package with a few clicks.

In doing so you can select:

- Product images, 2D dimension drawings, 3D models, internal circuit diagrams, EPLAN macro files
- Manuals, characteristics, operating manuals, certificates
- Product master data

You can find "mySupport" - CAx data on the Internet (<http://support.industry.siemens.com/my/ww/en/CAxOnline>).

Application examples

The application examples support you with various tools and examples for solving your automation tasks. Solutions are shown in interplay with multiple components in the system - separated from the focus on individual products.

You will find the application examples on the Internet (<https://support.industry.siemens.com/sc/ww/en/sc/2054>).

TIA Selection Tool

With the TIA Selection Tool, you can select, configure and order devices for Totally Integrated Automation (TIA).

This tool is the successor of the SIMATIC Selection Tool and combines the known configurators for automation technology into one tool.

With the TIA Selection Tool, you can generate a complete order list from your product selection or product configuration.

You can find the TIA Selection Tool on the Internet (<http://w3.siemens.com/mcms/topics/en/simatic/tia-selection-tool>).

SIMATIC Automation Tool

You can use the SIMATIC Automation Tool to perform commissioning and maintenance activities simultaneously on various SIMATIC S7 stations as a bulk operation independent of the TIA Portal.

General function overview:

- Network browsing and creation of a table showing the accessible devices in the network.
- Flashing of device LEDs or HMI display to locate a device
- Downloading of addresses (IP, subnet, gateway) to a device
- Downloading the PROFINET name (station name) to a device
- Placing a CPU in RUN or STOP mode
- Setting the time in a CPU to the current time of your PG/PC
- Downloading a new program to a CPU or an HMI device
- Downloading from CPU, downloading to CPU or deleting recipe data from a CPU
- Downloading from CPU or deleting data log data from a CPU
- Backup/restore of data from/to a backup file for CPUs and HMI devices
- Downloading service data from a CPU
- Reading the diagnostics buffer of a CPU
- Performing a CPU memory reset
- Resetting devices to factory settings
- Downloading a firmware update to a device

You can find the SIMATIC Automation Tool on the Internet (<https://support.industry.siemens.com/cs/ww/en/view/98161300>).

PRONETA

With SIEMENS PRONETA (PROFINET network analysis), you analyze the PROFINET network during commissioning. PRONETA features two core functions:

- The topology overview independently scans PROFINET network and all connected components.
- The IO check is a fast test of the wiring and the module configuration of a system.

You can find SIEMENS PRONETA on the Internet

(<https://support.industry.siemens.com/cs/ww/en/view/67460624>).

SINETPLAN

SINETPLAN, the Siemens Network Planner, supports you in planning automation systems and networks based on PROFINET. The tool facilitates professional and predictive dimensioning of your PROFINET installation as early as in the planning stage. In addition, SINETPLAN supports you during network optimization and helps you to exploit network resources optimally and to plan reserves. This helps to prevent problems in commissioning or failures during productive operation even in advance of a planned operation. This increases the availability of the production plant and helps improve operational safety.

The advantages at a glance

- Network optimization thanks to port-specific calculation of the network load
- Increased production availability thanks to online scan and verification of existing systems
- Transparency before commissioning through importing and simulation of existing STEP 7 projects
- Efficiency through securing existing investments in the long term and optimal exploitation of resources

You can find SINETPLAN on the Internet (<https://www.siemens.com/sinetplan>).

Product overview

2.1 Properties

Article number

6ES7522-1BF00-0AB0

View of the module

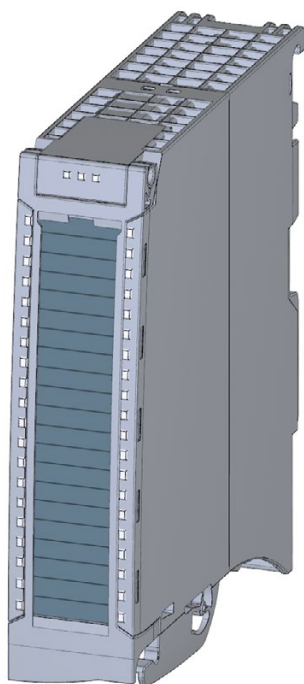

Figure 2-1 View of the DQ 8x24VDC/2A HF module

Properties

The module has the following technical properties:

- 8 digital outputs, electrically isolated in groups of 4
 - of which optional channels 0 and 4 are available for pulse width modulation (PWM).
- Rated output voltage 24 V DC
- Rated output current 2 A
- Configurable substitute values (per channel)
- Configurable diagnostics (per channel)
- Suitable for solenoid valves, contactors, DC contactors and indicator lights
- Switching cycle counter for connected actuators, e.g. solenoid valves

The module supports the following functions:

Table 2- 1 Version dependencies of the module functions

Function	Firmware version of the module	Configuration software	
		STEP 7 (TIA Portal)	GSD file in STEP 7 (TIA Portal) V12 or higher, or STEP 7 V5.5 SP3 or higher
Firmware update	V1.0.0 or higher	V12 or higher	--- / X
Identification data I&M0 to I&M3	V1.0.0 or higher	V12 or higher	X
Parameter assignment in RUN	V1.0.0 or higher	V12 or higher	X
Module-internal Shared Output (MSO)	V2.0.0 or higher	V13 Update 3 or higher (PROFINET IO only)	X (PROFINET IO only)
Pulse-width modulation (PWM) for channel 0 and 4	V2.1.0 or higher	as of V13, SP1 with HSP 0178	X (PROFINET IO only)
Switching cycle counter	V2.2.0 or higher	as of V15.0 with HSP0247 <ul style="list-style-type: none"> • PROFINET IO only • Central operation with a S7-1500 CPU is supported 	X (PROFINET IO only)

You can configure the module with STEP 7 (TIA Portal) and with a GSD file.

Compatibility

The following table shows the compatibility of the modules and the dependencies between hardware functional status (FS) and firmware version (FW) used:

Hardware functional status	Firmware version	Note
FS01	V1.0.0 to V2.1.0	Upgrade and downgrade possible between V1.0.0 and V2.1.0
FS02	V1.0.0 to V2.1.0	Upgrade and downgrade possible between V1.0.0 and V2.1.0
FS03	V2.2.0	Upgrade and downgrade possible between V2.2.0 and higher

Accessories

The following accessories are supplied with the module and can also be ordered separately as spare parts:

- Labeling strips
- U connector
- Universal front cover

Other components

The following component can be ordered separately:

Front connectors, including potential jumpers and cable ties

You can find additional information on accessories in the system manual S7-1500/ET 200MP. (<https://support.industry.siemens.com/cs/ww/en/view/59191792>)

2.2 Functions

2.2.1 Pulse-width modulation (PWM)

Channels 0 and 4 of the module support the pulse width modulation (PWM) function. The pulse width modulation function can be used to easily generate periodic pulses with a constant rated voltage and a variable pulse duration for the above-mentioned channels.

Advantages

- Automatic generation of periodic signals (without user program).
- Possibility of power reduction, e.g. in solenoid valves.

Typical areas of application:

- Control of proportional valves and way values (e.g. energy saving by reducing the holding current).
- Heating control e.g. via an external additional power unit.

Requirement

Firmware version as of V2.1.0 of the module.

Rules

Channels 0 and 4 can be used together and individually in pulse width modulation mode. The remaining channels can continue to be used as digital outputs.

Configuration

You configure the pulse width modulation with the following parameters:

- Pulse width modulation mode for activating the function
- Pulse width modulation (time period)

How it works

In the pulse width modulation mode, the two outputs (channels 0 and 4) provide one pulse width modulated output signal.

Pulse width modulation is characterized by its time period (frequency) and its duty factor (also referred to as ON period or Duty Cycle). The duty factor describes the relation between pulse duration and time period.

The pulse duration is derived from the time period and the duty factor: Pulse duration = duty factor x time period.

Example for duty factor of 50% and time period of 10 ms:

Pulse duration $0.5 \times 10 \text{ ms} = 5 \text{ ms}$

You define the duty factor for channels 0 and 4 in the user program using the output value (0 ... 1000) in the process image output; see section Address space operating mode pulse-width modulation (Page 29).

The output signal is a square wave signal (pulse sequence of on and off pulses).

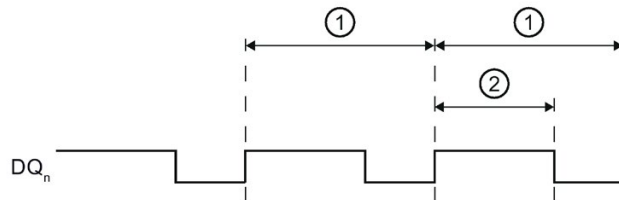

- ① Time period T (2 to 100 ms); Frequency of the pulse width modulation: $f = 1/T$ (10 to 500 Hz)
- ② Pulse duration (duty factor x time period)

Figure 2-2 How pulse width modulation works

Minimum pulse duration

The minimum pulse duration is 300 μs due to the hardware. The duty factor can be adjusted from 0.0 to 100.0%. The time period can be adjusted from 2 to 100 ms.

Example: If you configure a time period of 2 ms and set a duty factor of 10% for the output, this results in a pulse duration of 200 μs . In fact, the output works with a minimum pulse duration of 300 μs .

Pulse waveform

The pulse duration of the actual signal profile is slightly longer than the specified, ideal pulse duration.

The figure below shows the reaction of the output to control by PWM. The blue line shows the specified, ideal signal profile (square wave signal), with which the output is controlled. The red dashed line shows the actual signal profile on the output terminal, caused by the externally connected load.

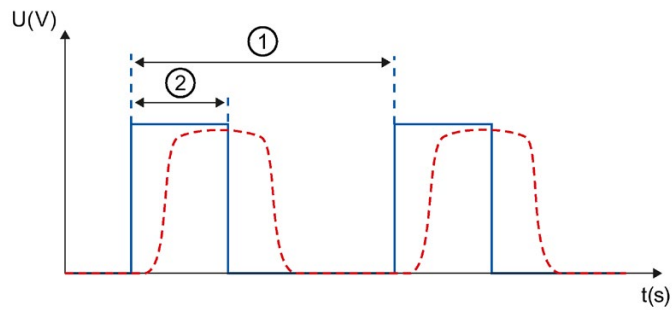

- ① Time period
- ② Pulse duration (duty factor x time period)

Figure 2-3 Pulse waveform at output terminal

Example for energy saving by reducing the holding current

High starting current is required to activate a solenoid valve. When the solenoid valve is activated, the current requirement is lower; it only has to be held in position. This time-dependent current requirement can be met well with the PWM function.

The "ValveControl" function block shown below sets the holding current required by a solenoid valve only after the configured time (HoldTime) has expired. You can generate the required holding current with a duty factor (PWM duty cycle << 100%). While "HoldTime" is running, the output is set (duty factor = 100 %) to generate a high starting torque for the solenoid valve.

```

FUNCTION_BLOCK "ValveControl"
{ S7_Optimized_Access := 'FALSE' }
VERSION : 0.1
VAR_INPUT
    OutputTrigger : Bool; // Binary control of the output
    HoldTime : Time; // Length of time until the PWM output begins
    PWM_DutyCycle : Int; // PWM duty cycle after hold time
END_VAR
VAR_OUTPUT
    PWM_Out : Int; // Value for PWM output
END_VAR
VAR
    Hold_TON {OriginalPartName := 'TON'; LibVersion := '1.0'} :
TON;
END_VAR

BEGIN

#Hold_TON(IN:=#OutputTrigger,
    PT:=#HoldTime);
IF #OutputTrigger = FALSE THEN
    #PWM_Out := 0;
    RETURN;
END_IF;
    IF #Hold_TON.Q THEN
        // Hold time expired => switch to PWM mode
        #PWM_Out := #PWM_DutyCycle;
    ELSE
        // Control output to 100% during hold time
        #PWM_Out := 1000;
    END_IF;

END_FUNCTION_BLOCK

```

2.2.2 Switching cycle counter

The function records the number of switching cycles of the output and thus the switching cycles of a connected actuator, such as those of solenoid valves. When the specified number of switching cycles is reached, the "Limit value warning" maintenance interrupt is triggered, provided it is configured and enabled. When replacing the actuator, you can reset the switching cycle counter from the user program.

When replacing modules, you have the option of pre-initializing the switching cycle counter from the user program.

Typical areas of application:

- Recording the number of switching cycles of the connected devices, e.g. solenoid valves or load contactors
- Predictive maintenance

Advantages

- You configure this function instead of programming.
- "Monitoring" of each individual channel is possible. You can select which outputs are "monitored".
- You can adapt the plant configuration flexibly and individually.
- Easy to service and maintain. You can enable and disable the switching cycle counter via the user program.
- Increase in plant availability. You can schedule actuator replacement in advance for the next maintenance cycle.

Requirement

Firmware version as of V2.2.0 of the module.

Configuration

You configure the switching cycle counter with the following parameters:

- Switching cycle counter enabled/disabled
- Trigger maintenance interrupt when the limit is reached
- Set limit for maintenance interrupt

How it works

The module counts the switching cycles by evaluating the rising edges of an output signal. If the module detects a rising edge, the switching cycle counter (24-bit) for the respective channel is incremented. After an overflow of the switching cycle counter, it starts again with 0.

If you activate the "Maintenance switching cycles" parameter, the "Limit warning" of the maintenance interrupt is triggered when the limit is exceeded. Alternatively, activate the maintenance interrupt in the parameter data sets starting at DS 64.

The current counter states are stored on the module cyclically (approx. every 20 seconds) and retentively. The switching cycle counters are reset each time the module is restarted (power off/on).

You activate the function with the "Switching cycle counter" parameter or in the parameter data sets starting at DS 64.

You can read the current counter states with data set DS 129. Data set DS 129 contains the counter status for each channel in UDINT format.

You can read the limits for each channel in UDINT format with data set DS 130.

Data set DS 131 enables you to overwrite the current counter value for each switching cycle counter.

You can set a limit for each switching cycle counter with the "Switching cycle limit" parameter or with data set DS 131.

Wiring

This section contains the block diagram of the module and outlines various wiring options. You can find information on wiring the front connector, establishing a cable shield, etc. in the "Wiring" section of system manual S7-1500/ET 200MP (<https://support.industry.siemens.com/cs/ww/en/view/59191792>).

Wiring and block diagram

The example in the following figure shows the terminal assignment and the assignment of the channels. You can optionally assign parameters to channels 0 and channel 4 for pulse width modulation mode.

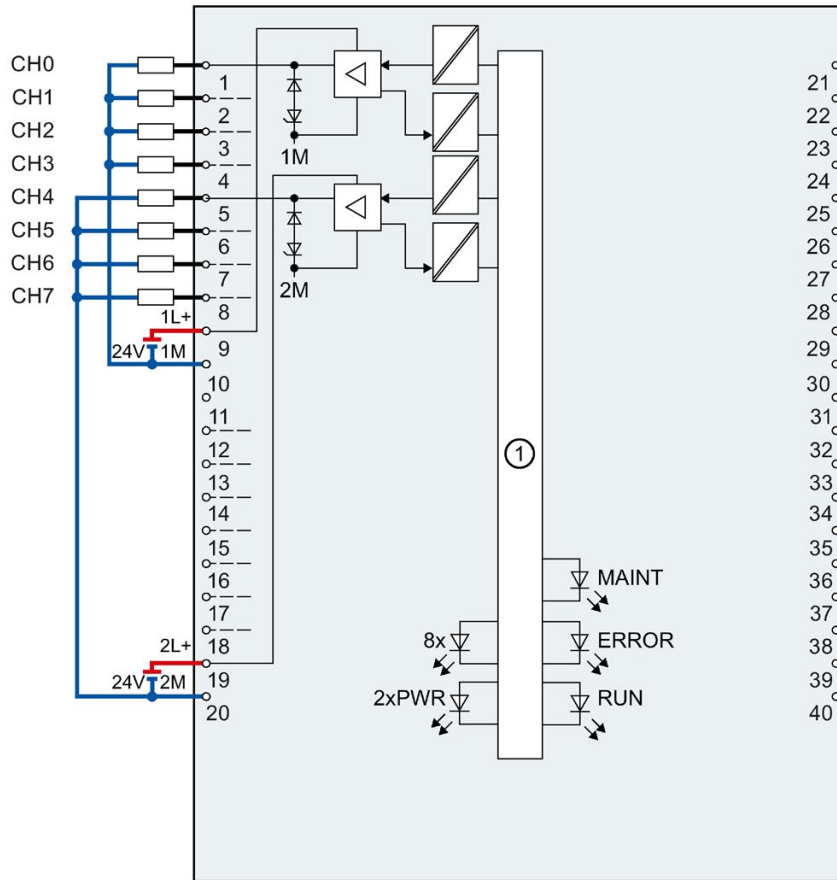

①	Backplane bus interface	MAINT	LED maintenance display (yellow)
xL+	Supply voltage 24 V DC	RUN	Status display LED (green)
xM	Ground	ERROR	Error display LED (red)
CHx	Channel or channel status LED (green/red)	PWR	POWER supply voltage LED (green)

Figure 3-1 Block diagram and terminal assignment

Wiring of the outputs for channels 0 and 4 for inductive load

If you set the channel 0 and channel 4 for the pulse width modulation mode, then you need to wire the outputs CH0 and CH4 with an external diode (blocking voltage $U_R > 60\text{ V}$; let-through current $I_F > 1.5\text{ A}$); see figure below.

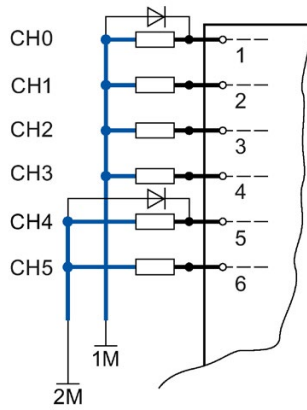

Figure 3-2 Wiring of the outputs for inductive load

Parameters/address space

4.1 Parameters

DQ 8x24VDC/2A HF parameters

When you assign the module parameters in STEP 7, you use various parameters to specify the module properties. The following table lists the configurable parameters. The effective range of the configurable parameters depends on the type of configuration. The following configurations are possible:

- Central operation with a S7-1500 CPU
- Distributed operation on PROFINET IO in an ET 200MP system
- Distributed operation on PROFIBUS DP in an ET 200MP system

For parameter assignment in the user program, the parameters are transferred to the module using the WRREC instruction (parameter assignment in RUN) and data records; see chapter Parameter assignment (Page 43).

4.1 Parameters

4.1.1 DQ operating mode parameter

DQ 8x24VDC/2A HF parameters

The table below lists the parameters in DQ mode. These parameters apply to channels 0 to 7.

Table 4- 1 Configurable parameters and their defaults

Parameters	Range of values	Default setting	Parameter assignment in RUN	Scope with configuration software, e.g., STEP 7 (TIA Portal)	
				Integrated in the hardware catalog STEP 7 (TIA Portal) as of V12 or GSD file PROFINET IO	GSD file PROFIBUS DP
Diagnostics					
• No supply voltage L+	Yes/No	No	Yes	Channel*	Channel group
• Short circuit to ground	Yes/No	No	Yes	Channel	Channel group
• Maintenance switching cycles	Yes/No	No	Yes	Channel (as of V15.0 with HSP0247)	---
• Switching cycle counter	Yes/No	No	Yes	Channel (as of V15.0 with HSP0247)	---
Reaction to CPU STOP	<ul style="list-style-type: none"> • Turn off • Keep last value • Output substitute value 1 	Turn off	Yes	Channel	Channel
Switching cycle limits					
Switching cycle limit	0 ... 16777214	0	Yes	Channel (as of V15.0 with HSP0247)	---

* If you enable diagnostics for multiple channels, you will receive an alarm surge on failure of the supply voltage because each enabled channel will detect this fault. You can prevent this message burst by assigning the diagnostics function to one channel only.

4.1.2 Explanation of the parameters of DQ mode

No supply voltage

Enabling of the diagnostics, for lacking or insufficient supply voltage L+.

Short circuit to ground

Enabling of the diagnostics if a short-circuit of the actuator supply to ground occurs.

Maintenance switching cycles

You use this parameter to enable the maintenance interrupt "Limit value warning" when the switching cycle limit is violated.

You configure the limit with the parameter "Switching cycle limit" for each channel CHx.

Switching cycle counter

Channel-by-channel enable of switching cycle counter (Page 17).

Reaction to CPU STOP

Determines the reaction of the output when the CPU goes into the STOP state or when the connection to the CPU is interrupted.

Switching cycle limit

Defines the limit channel-by-channel. If this value is exceeded, the "Limit value warning" maintenance interrupt is signaled.

Enter an integer value between 0 and 16777214. Refer to the data sheet of the connected actuator. We recommend that you do not enter this maximum value, but instead set it to 80% or 90%, for example, so that you have enough time to replace the actuator as a preventive measure.

4.1 Parameters

4.1.3 Pulse width modulation operating mode parameter

DQ 8x24VDC/2A HF parameters

The table below lists the parameters in pulse width modulation mode. These parameters apply to channels 0 and 4.

Table 4- 2 Configurable parameters and their defaults

Parameters	Range of values	Default setting	Parameter assignment in RUN	Scope with configuration software, e.g., STEP 7 (TIA Portal)	
				Integrated in the hardware catalog as of STEP 7 (TIA Portal) as of V 13 SP1 GSD file PROFINET IO	GSD file PROFIBUS DP
Diagnostics					
• No supply voltage L+	Yes/No	No	Yes	Channel	---
• Short circuit to ground	Yes/No	No	Yes	Channel	---
Reaction to CPU STOP	<ul style="list-style-type: none"> • Turn off • Keep last value 	Turn off	Yes	Channel	---
Operating mode	<ul style="list-style-type: none"> • Digital output (DQ) • Pulse width modulation 	Digital output DQ	Yes	Channel	---
Pulse width modulation (Period duration)	2 ... 100 ms*	10 ms	No	Module	---

* 20 ... 1000 [x 0.1] with GSD file

4.1.4 Explanation of the parameters of pulse width modulation mode

Missing supply voltage

Enabling of the diagnostics for missing or insufficient supply voltage L+.

Short-circuit to ground

Enabling of the diagnostics if a short-circuit of the actuator supply to ground occurs.

Reaction to CPU STOP

Determines the reaction of the output when the CPU goes into the STOP state or when the connection to the CPU is interrupted.

Operating mode

Specifies the operating mode in which the channels 0 and 4 of the module are operated.

- Digital output DQ as digital output channel
- Pulse width modulation, see section Pulse-width modulation (PWM) (Page 13)

Pulse width modulation time period

Specifies the period duration and therefore the frequency of the pulse width modulation. See section Pulse-width modulation (PWM) (Page 13)

4.2 Address space

The module can be configured differently in STEP 7; see following table. Depending on the configuration, additional/different addresses are assigned in the process image of the outputs/inputs.

Configuration options of DQ 8x24VDC/2A HF

You can configure the module with STEP 7 (TIA Portal) or with a GSD file.

When you configure the module by means of the GSD file, the configurations are available under different abbreviations/module names.

The following configurations are possible:

Table 4-3 Configuration options

Configuration	Short designation/module name in the GSD file	Configuration software, e.g., STEP 7 (TIA Portal)	
		Integrated in hardware catalog STEP 7 (TIA Portal)	GSD file in STEP 7 (TIA Portal) V12 or higher or STEP 7 V5.5 SP3 or higher
1 x 8-channel without value status	DQ 8x24VDC/2A HF	X	X
1 x 8-channel with value status	DQ 8x24VDC/2A HF QI	X	X
1 x 8-channel with value status for module-internal Shared Output with up to 4 submodules	DQ 8x24VDC/2A HF MSO	V13 Update 3 or higher (PROFINET IO only)	X (PROFINET IO only)
1 x 8-channel with value status (channel 0 and channel 4 for PWM)	DQ 8x24VDC/2A HF PWM	as of V13 SP1 with HSP 0178	X (PROFINET IO only)

Value status (Quality Information, QI)

The value status is always activated for the following module names:

- DQ 8x24VDC/2A HF QI
- DQ 8x24VDC/2A HF MSO
- DQ 8x24VDC/2A HF PWM

An additional bit is assigned to each channel for the value status. The bit for the value status indicates if the output value specified by the user program is actually pending at the module terminal (0 = value is incorrect).

Note

The maintenance interrupt "Limit value warning" has no effect on the value status.

4.2.1 Address space operating mode DQ

Address space for configuration as 8-channel DQ 8x24VDC/2A HF

The following figure shows the assignment of the address space for the configuration as a 8-channel module with value status. You can freely assign the start address for the module. The addresses of the channels are derived from the start address.

The letter "a" is printed on the module; "AB a" stands for module start address output byte a.

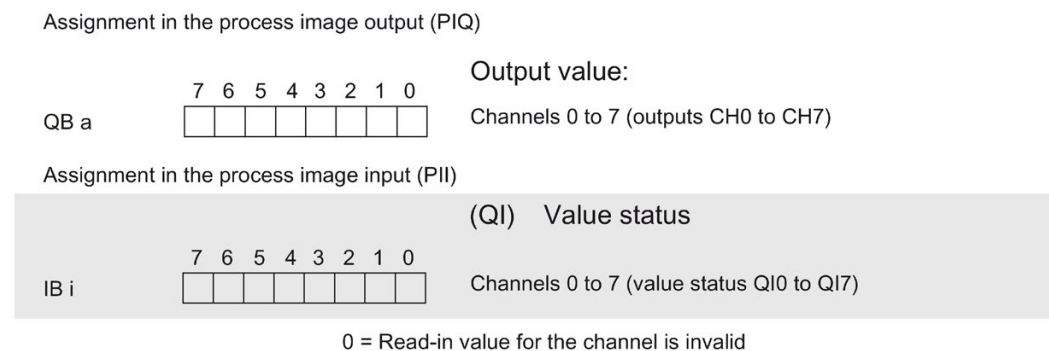

Figure 4-1 Address space for configuration as 8-channel DQ 8x24VDC/2A HF with value status

Address space for configuration as 1 x 8-channel DQ 8x24VDC/2A HF MSO

For the configuration as a 1 x 8-channel module (module-internal Shared Output, MSO), channels 0 to 7 of the module are copied to multiple submodules. Channels 0 to 7 are then available with identical values in various submodules. These submodules can be assigned to up to four IO controllers when the module is used in a shared device:

- The IO controller to which submodule 1 is assigned has write access to outputs 0 to 7.
- The IO controllers to which submodule 2, 3, or 4 is assigned have read access to outputs 0 to 7.

The number of usable IO controllers depends on the interface module used. Observe the information in the manual for the particular interface module.

Value status (Quality Information, QI)

The meaning of the value status depends on the submodule on which it occurs.

For the first submodule (=basic submodule), the value status 0 indicates that the value is incorrect or that the IO controller of the basic submodule is in STOP state.

For 2nd to 4th submodule (=MSO submodule), the value status 0 indicates that the value is incorrect or one of the following errors has occurred:

- The basic submodule is not yet configured (not ready).
- The connection between the IO controller and the basic submodule has been interrupted.
- The IO controller of the basic submodule is in STOP or POWER OFF state.

4.2 Address space

The following figure shows the assignment of the address space for submodules 1, 2, 3, and 4 and the value status.

Assignment in the process image of the outputs (PIO) for 1st submodule

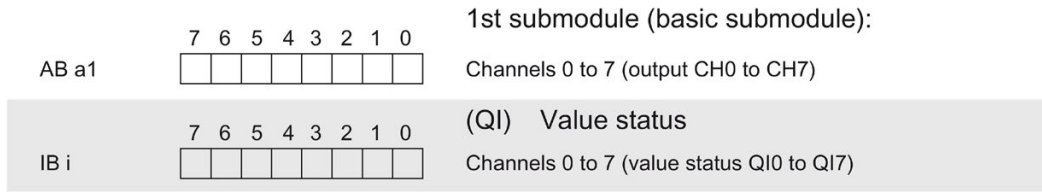

Assignment in the process image of the inputs (PII) for 2nd submodule

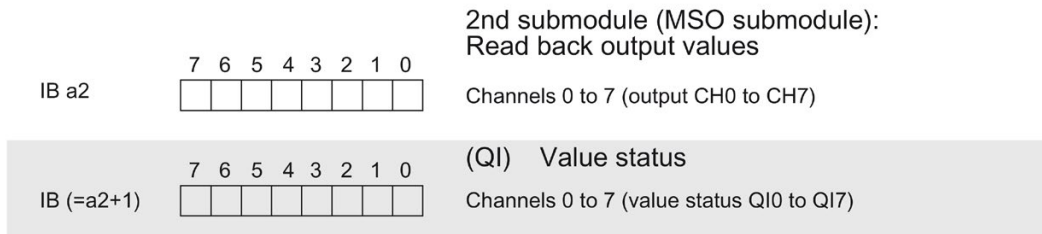

Assignment in the process image of the inputs (PII) for 3rd submodule

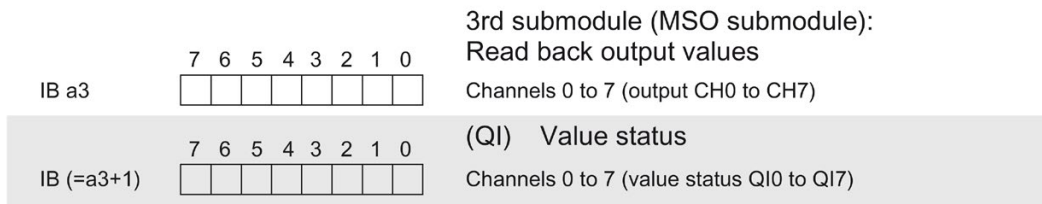

Assignment in the process image of the inputs (PII) for 4th submodule

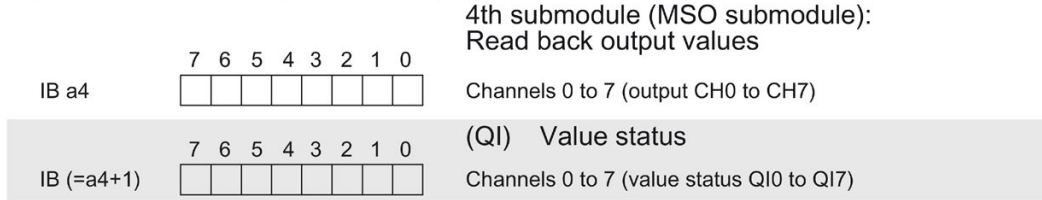

0 = Value read at the channel is faulty

Figure 4-2 Address space for configuration as 1 x 8-channel DQ 8x24VDC/2A HF MSO with value status

Reference

You can find information on the Shared Input/Output (MSI/MSO) function in the section Module-Internal Shared Input/Output (MSI/MSO) of the PROFINET with STEP 7 V13 (<https://support.industry.siemens.com/cs/ww/en/view/49948856>) function manual.

4.2.2 Address space operating mode pulse-width modulation

Address space for configuration as 1 x 8-channel DQ 8x24VDC/2A PWM

If you use the module in the "Pulse width modulation mode" (channels 0 and 4), the module uses the following address spaces:

- 6 bytes in the process image output
- 1 byte in the process image input

Allocation of the process image

If you have set "Pulse width modulation" mode for channels 0 and 4 in the parameter, bits 0 and 4 have no significance. Enter the on-load factor (duty factor) in the following output bytes; see the figure below.

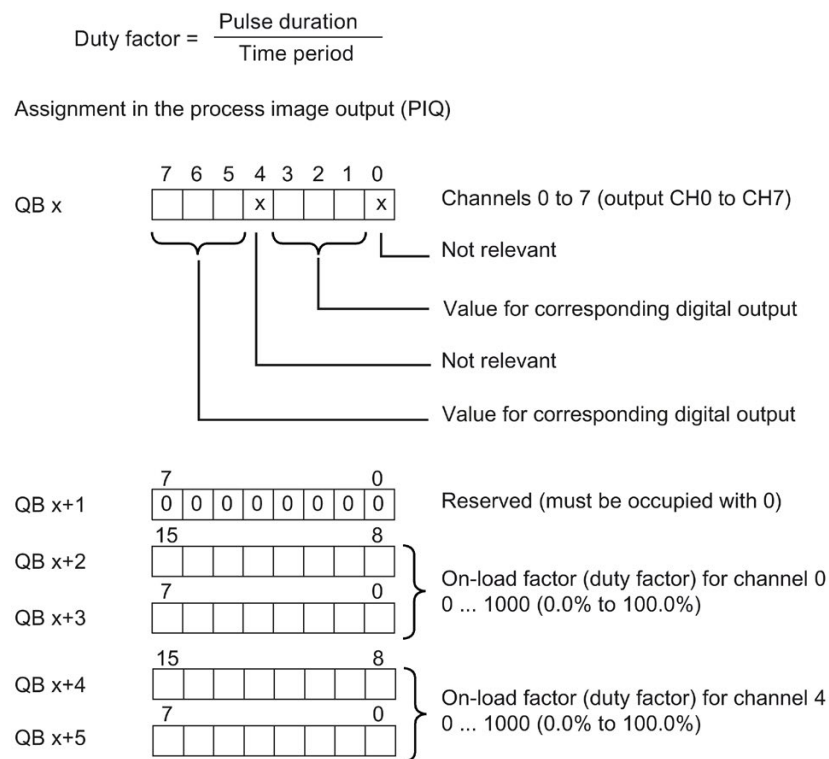

Figure 4-3 Allocation in the process image output

The figure below shows the address assignment of the module.

Assignment in the process image input (PII)

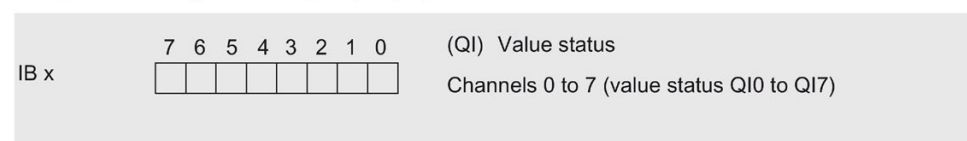

Figure 4-4 Allocation in the process image of the inputs

Interrupts/diagnostics alarms

5.1 Status and error displays

LED displays

The following figure shows the LED displays (status and error displays) of DQ 8x24VDC/2A HF.

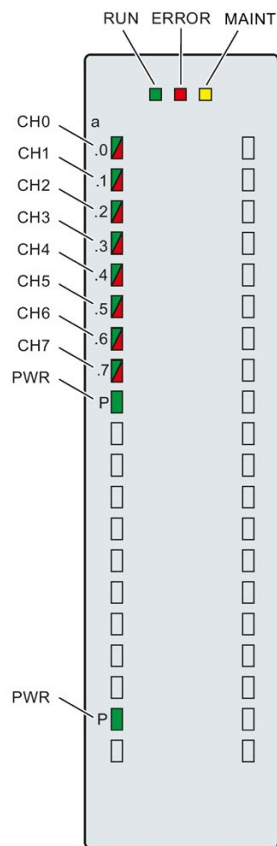

Figure 5-1 LED displays of the DQ 8x24VDC/2A HF module

Meaning of the LED displays

The following table explains the meaning of the status and error displays. Remedial measures for diagnostic alarms can be found in section Diagnostic alarms (Page 33).

RUN and ERROR LED

Table 5- 1 Status and error displays RUN and ERROR

LED		Meaning	Solution
RUN	ERROR		
□ Off	□ Off	Voltage missing or too low at backplane bus.	<ul style="list-style-type: none"> Switch on the CPU and/or the system power supply modules. Verify that the U connectors are inserted. Check to see if too many modules are inserted.
☀ Flashes	□ Off	The module starts and flashes until the valid parameter assignment is set.	---
■ On	□ Off	Module is configured.	---
■ On	☀ Flashes	Indicates module errors (at least one error at one channel, e.g., short-circuit to ground).	Evaluate the diagnostics data and eliminate the error (e.g., check the cables).
☀ Flashes	☀ Flashes	Hardware defective.	Replace the module.

LED MAINT

Table 5- 2 MAINT status display

LED MAINT	Meaning	Solution
□ Off	0 = No maintenance interrupt is pending.	---
■ On	1 = The maintenance interrupt "Limit value warning" is pending.	---

LED PWR

Table 5- 3 PWR status display

LED PWR	Meaning	Solution
□ Off	Supply voltage L+ too low or missing.	Check supply voltage L+.
■ On	Supply voltage L+ is present and OK.	---

LED CHx

Table 5- 4 CHx status display

LED CHx	Meaning	Solution
□ Off	0 = Status of the output signal.	---
■ On	1 = Status of the output signal.	---
■ On	Channel parameters assigned (channel fault pending; a short-circuit to ground is pending at the respective channel).	Check the wiring and remedy the short-circuit to ground.
	Supply voltage L+ too low or missing.	Check supply voltage L+.

5.2 Interrupts

The digital output module DQ 8x24VDC/2A HF supports diagnostic interrupts and maintenance interrupts.

You can find detailed information on the error event in the error organization block with the "RALRM" instruction (read additional interrupt info) and in the STEP 7 online help.

Diagnostic interrupt

The module generates a diagnostic interrupt at the following events:

- No supply voltage L+
- Short circuit to ground
- Parameter assignment error

Maintenance interrupt

The module generates a maintenance interrupt at the following events:

- Limit value warning

5.3 Diagnostics alarms

Diagnostics alarms

A diagnostics alarm is generated and the ERROR LED flashes for each diagnostics event on the module. The diagnostics alarms can be read out in the diagnostics buffer of the CPU, for example. You can evaluate the error codes with the user program.

If the module is operated distributed with PROFIBUS DP in an ET 200MP system, you have the option to read out diagnostics data with the instruction RDREC or RD_REC using data record 0 and 1. The structure of the data records is available on the Internet in the "Manual for interface module IM 155-5 DP ST (6ES7155-5BA00-0AB0)".

Table 5- 5 Diagnostics alarms, their meaning and corrective measures

Diagnostics alarm	Error code	Meaning	Corrective measures
Short-circuit to ground*	1H	Short-circuit or overload at the channel	Check the wiring/actuator. Check the ambient temperature.
Parameter assignment error	10H	<ul style="list-style-type: none"> The module cannot evaluate parameters for the channel Incorrect parameter assignment 	Correct the parameter assignment
Load voltage missing	11H	Supply voltage L+ of the module is missing	Connect supply voltage L+ to module/channel
Limit value warning	17H	The configured limit for switching cycles has been exceeded.	<ul style="list-style-type: none"> Replace actuator as a precautionary measure Reset counter with DS131

* This diagnostic message can be output with pulse duration <500 microseconds in pulse width modulation mode. Disable the diagnostics of pulse duration < 500 µs.

Technical specifications

Technical specifications of the DQ 8x24VDC/2A HF

The following table shows the technical specifications as of 06/2018. You will find a data sheet including daily updated technical specifications on the Internet (<https://support.industry.siemens.com/cs/ww/en/pv/6ES7522-1BF00-0AB0/td?dl=en>).

Article number	6ES7522-1BF00-0AB0
General information	
Product type designation	DQ 8x24VDC/2A HF
HW functional status	FS03
Firmware version	V2.2.0
<ul style="list-style-type: none"> FW update possible 	Yes
Product function	
<ul style="list-style-type: none"> I&M data 	Yes; I&M0 to I&M3
Engineering with	
<ul style="list-style-type: none"> STEP 7 TIA Portal configurable/integrated as of version 	V13 SP1 / -
<ul style="list-style-type: none"> STEP 7 configurable/integrated as of version 	V5.5 SP3 / -
<ul style="list-style-type: none"> PROFIBUS as of GSD version/GSD revision 	V1.0 / V5.1
<ul style="list-style-type: none"> PROFINET as of GSD version/GSD revision 	V2.3 / -
Operating mode	
<ul style="list-style-type: none"> DQ 	Yes
<ul style="list-style-type: none"> DQ with energy-saving function 	Yes; with an application
<ul style="list-style-type: none"> PWM 	Yes
<ul style="list-style-type: none"> Cam control (switching at comparison values) 	No
<ul style="list-style-type: none"> Oversampling 	No
<ul style="list-style-type: none"> MSO 	Yes
<ul style="list-style-type: none"> Integrated operating cycle counter 	Yes

Article number	6ES7522-1BF00-0AB0
Supply voltage	
Rated value (DC)	24 V
permissible range, lower limit (DC)	20.4 V
permissible range, upper limit (DC)	28.8 V
Reverse polarity protection	Yes; through internal protection with 10 A per group
Input current	
Current consumption, max.	40 mA; 20 mA per group, no output is activated.
Output voltage	
Rated value (DC)	24 V
Power	
Power available from the backplane bus	0.9 W
Power loss	
Power loss, typ.	5.6 W; 6.8 W for PWM operation
Digital outputs	
Type of digital output	Transistor
Number of digital outputs	8
Current-sourcing	Yes
Short-circuit protection	Yes
• Response threshold, typ.	3 A
Limitation of inductive shutdown voltage to	-17 V
Controlling a digital input	Yes
Digital output functions, parameterizable	
• Freely usable digital output	Yes
• PWM output	Yes
– Number, max.	2
– Cycle duration, parameterizable	Yes; 2 ... 100 ms continuous
– ON period, min.	0 %
– ON period, max.	100 %
– Resolution of the duty cycle	0.1 %
– Minimum pulse duration	300 µs
Switching capacity of the outputs	
• on lamp load, max.	10 W
Load resistance range	
• lower limit	12 Ω
• upper limit	4 kΩ
Output voltage	
• for signal "1", min.	L+ (-0.8 V)

Article number	6ES7522-1BF00-0AB0
Output current	
<ul style="list-style-type: none"> for signal "1" rated value 	2 A
<ul style="list-style-type: none"> for signal "1" permissible range, max. 	2.4 A; Note derating specification for PWM operation
<ul style="list-style-type: none"> for signal "0" residual current, max. 	0.5 mA
Output delay with resistive load	
<ul style="list-style-type: none"> "0" to "1", typ. 	80 µs
<ul style="list-style-type: none"> "0" to "1", max. 	100 µs
<ul style="list-style-type: none"> "1" to "0", typ. 	300 µs
<ul style="list-style-type: none"> "1" to "0", max. 	500 µs
Parallel switching of two outputs	
<ul style="list-style-type: none"> for logic links 	Yes
<ul style="list-style-type: none"> for uprating 	No
<ul style="list-style-type: none"> for redundant control of a load 	Yes
Switching frequency	
<ul style="list-style-type: none"> with resistive load, max. 	100 Hz; With PWM operation: 500 Hz
<ul style="list-style-type: none"> with inductive load, max. 	0.5 Hz; According to IEC 60947-5-1, DC-13; max. 500 Hz with PWM operation only with external circuit; see additional description in the manual
<ul style="list-style-type: none"> on lamp load, max. 	10 Hz
Total current of the outputs	
<ul style="list-style-type: none"> Current per channel, max. 	2 A; see additional description in the manual
<ul style="list-style-type: none"> Current per group, max. 	8 A; see additional description in the manual
<ul style="list-style-type: none"> Current per module, max. 	16 A; see additional description in the manual
Cable length	
<ul style="list-style-type: none"> shielded, max. 	1 000 m
<ul style="list-style-type: none"> unshielded, max. 	600 m
Isochronous mode	
Isochronous operation (application synchronized up to terminal)	No
Interrupts/diagnostics/status information	
Diagnostics function	Yes
Substitute values connectable	Yes
Alarms	
<ul style="list-style-type: none"> Diagnostic alarm 	Yes

Article number	6ES7522-1BF00-0AB0
Diagnostic messages	
<ul style="list-style-type: none"> Monitoring the supply voltage Wire-break Short-circuit Group error 	<p>Yes</p> <p>No</p> <p>Yes</p> <p>Yes</p>
Diagnostics indication LED	
<ul style="list-style-type: none"> RUN LED ERROR LED MAINT LED Monitoring of the supply voltage (PWR-LED) Channel status display for channel diagnostics for module diagnostics 	<p>Yes; Green LED</p> <p>Yes; Red LED</p> <p>Yes; yellow LED</p> <p>Yes; Green LED</p> <p>Yes; Green LED</p> <p>Yes; Red LED</p> <p>Yes; Red LED</p>
Potential separation	
Potential separation channels	
<ul style="list-style-type: none"> between the channels between the channels, in groups of between the channels and backplane bus 	<p>No</p> <p>4</p> <p>Yes</p>
Isolation	
Isolation tested with	707 V DC (type test)
Standards, approvals, certificates	
Suitable for safety-related tripping of standard modules	Yes; From FS03
Highest safety class achievable for safety-related tripping of standard modules	
<ul style="list-style-type: none"> Performance level according to ISO 13849-1 Category according to ISO 13849-1 SILCL according to IEC 62061 	<p>PL d</p> <p>Cat. 3</p> <p>SILCL 2</p>
Decentralized operation	
Prioritized startup	Yes
Dimensions	
Width	35 mm
Height	147 mm
Depth	129 mm
Weights	
Weight, approx.	240 g

Power reduction (derating) to aggregate current of outputs (per group)

The following graphs show the loading capacity of the outputs in relation to the mounting position and the ambient temperature.

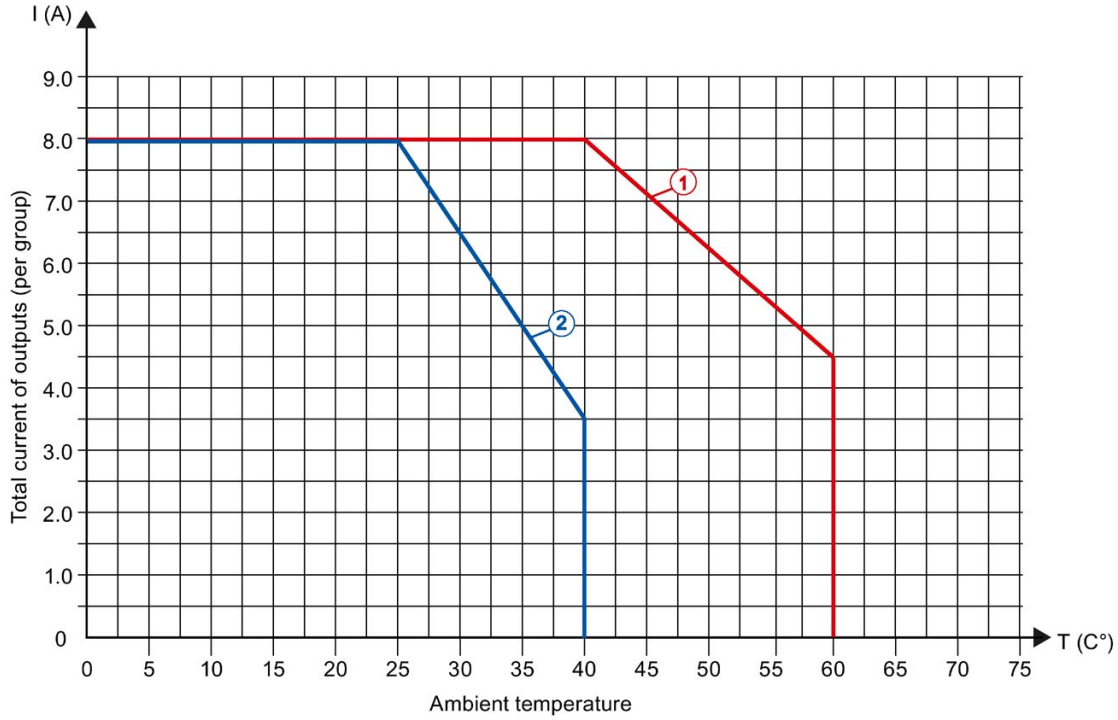

- ① Horizontal mounting of the system
- ② Vertical mounting of the system

Figure 6-1 Details on total current of outputs (per group)

DQ mode and PWM mode with switching frequency max. 100 Hz

The following graphs apply to resistive loads and inductive loads with max. 2 A total current of the outputs per channel. Inductive loads in PWM mode require additional wiring to an external diode; see section Wiring (Page 19). You can find the total current of the outputs for each channel or for each module in the technical specifications.

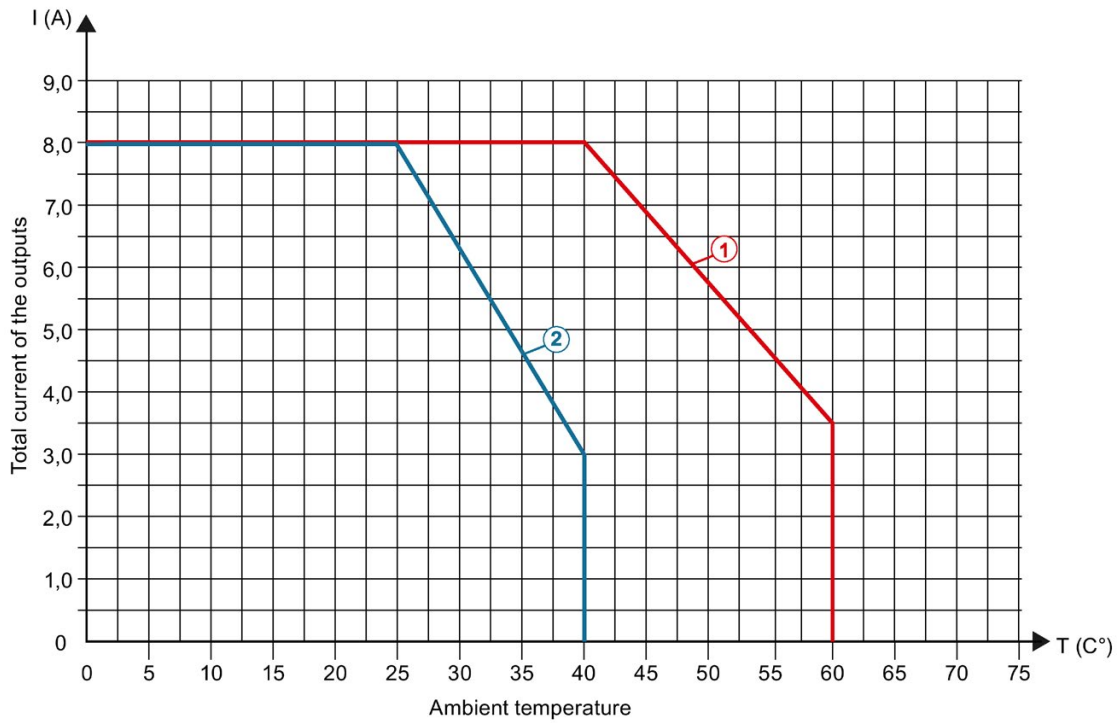

- ① Horizontal mounting of the system
- ② Vertical mounting of the system

Figure 6-2 Details on total current of outputs (per group) in the DQ and PWM operating modes

PWM mode with switching frequency max. 500 Hz

The following graphs apply to resistive loads and inductive loads with max. 2 A total current of the outputs per channel. Inductive loads require additional wiring with an external diode, see section Wiring (Page 19). You can find the total current of the outputs for each channel or for each module in the technical specifications.

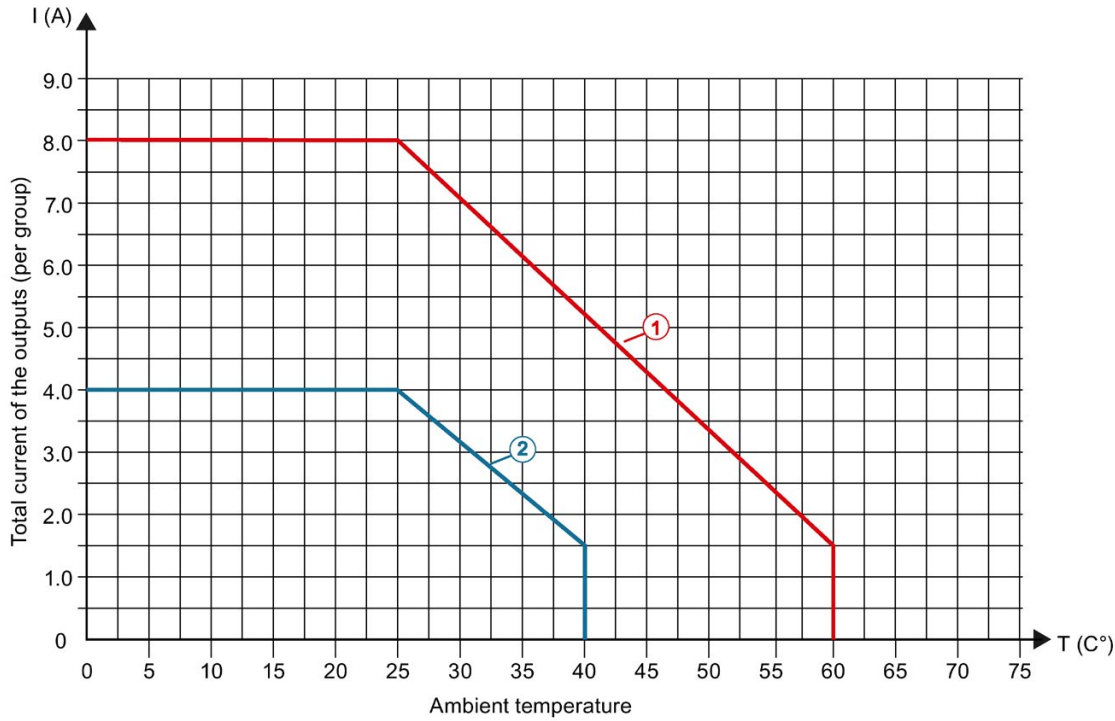

- ① Horizontal mounting of the system
- ② Vertical mounting of the system

Figure 6-3 Details on total current of outputs (per group) in the PWM operating mode

Dimensional drawing

A

The dimensional drawing of the module on the mounting rail, as well as a dimensional drawing with open front cover, are provided in the appendix. Always observe the specified dimensions for installations in cabinets, control rooms, etc.

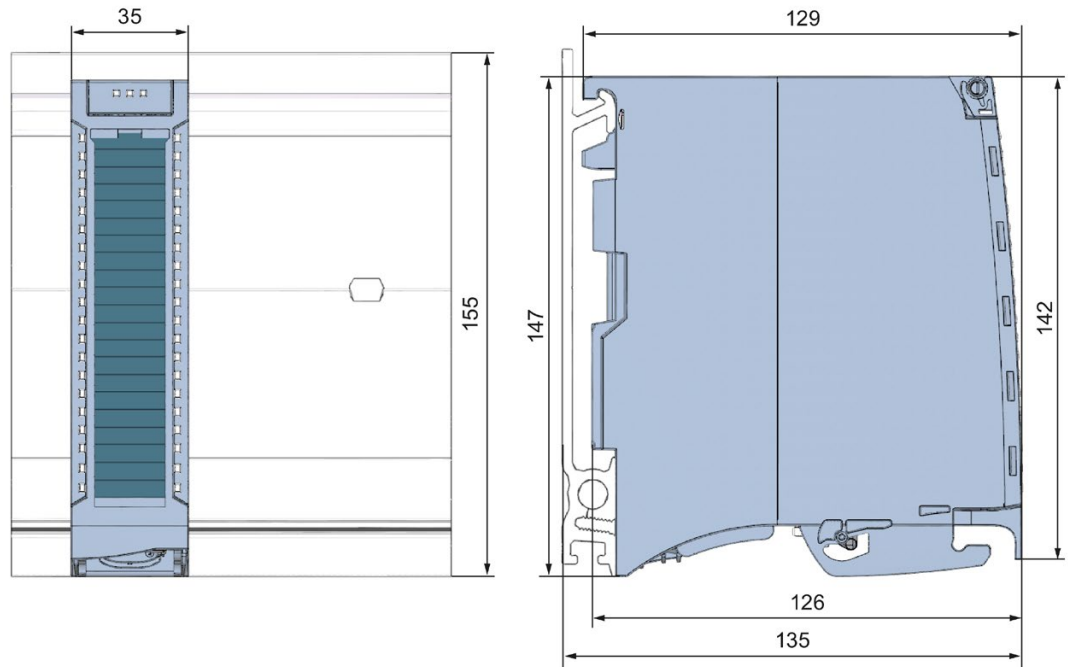

Figure A-1 Dimensional drawing of the DQ 8x24VDC/2A HF module

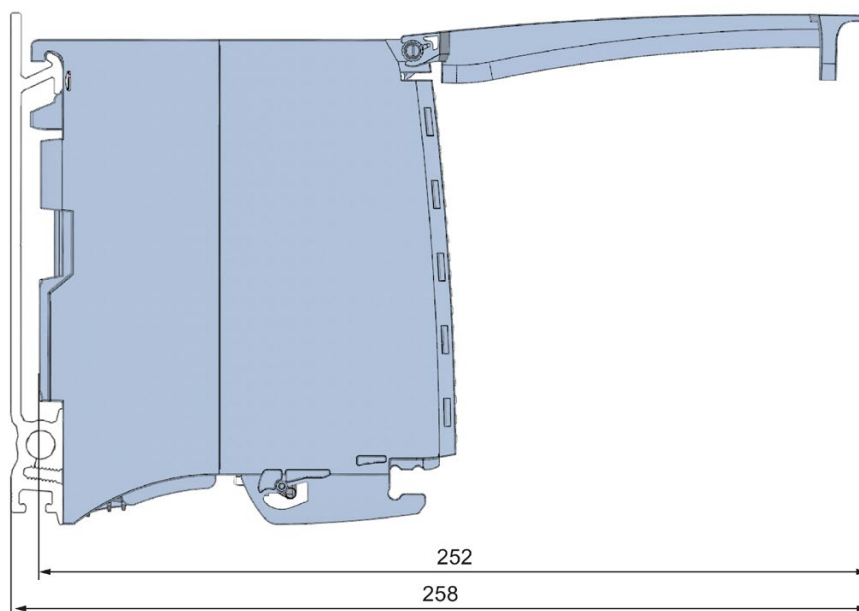

Figure A-2 Dimensional drawing of the DQ 8x24VDC/2A HF module, side view with open front cover

Parameter data records

B.1 Parameter assignment

The data records of the module have an identical structure, regardless of whether you configure the module with PROFIBUS DP or PROFINET IO.

Dependencies for configuration with GSD file

When a GSD file is used to configure a module, dependencies can arise when "assigning the parameters".

There are no dependencies for this module. You can assign the individual parameters in any combination.

Parameter assignment in the user program

You have the option to reconfigure the module in RUN (e.g. the response of selected channels to the CPU-STOP state can be changed in RUN without having an effect on the other channels).

Parameter assignment in RUN

The WRREC instruction is used to transfer the parameters to the module using data sets 64 to 71. The parameters set in STEP 7 do not change in the CPU, which means the parameters set in STEP 7 are still valid after a restart.

The parameters are only checked for plausibility by the module after the transfer.

Output parameter STATUS

The module ignores errors that occurred during the transfer of parameters with the WRREC instruction and continues operation with the previous parameter assignment. However, a corresponding error code is written to the STATUS output parameter.

The description of the WRREC instruction and the error codes is available in the STEP 7 online help.

Assignment of data record and channel

The channel parameters of the module are included in data sets 64 to 71 and are assigned as follows:

- Data set 64 for channel 0 (PWM operating mode possible)
- Data record 65 for channel 1
- Data set 66 for channel 2
- Data set 67 for channel 3
- Data set 68 for channel 4 (PWM operating mode possible)
- Data set 69 for channel 5
- Data set 70 for channel 6
- Data set 71 for channel 7

B.2 Structure of parameter data sets DS 64 - 71

Structure of data sets 64 to 71

The figure below shows the structure of data set 64 for channel 0 as an example. The structure is identical for channels 1 to 7. The values in byte 0 and byte 1 are fixed and may not be changed.

Enable a parameter by setting the corresponding bit to "1".

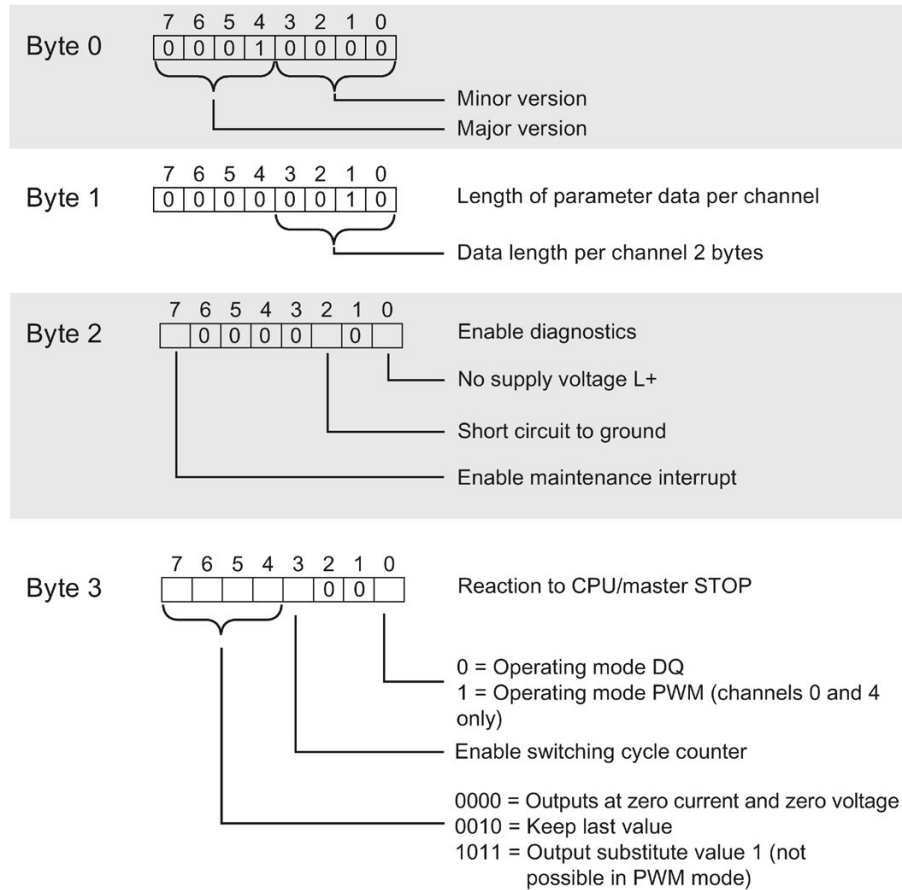

Figure B-1 Structure of data set 64: Bytes 0 to 3

B.3 Structure of data set DS 129

Structure of data set 129

You can read the current states of the switching cycle counters with data set 129. The counter status is supplied for each channel in UDINT format.

The following figure shows you the structure of data set 129.

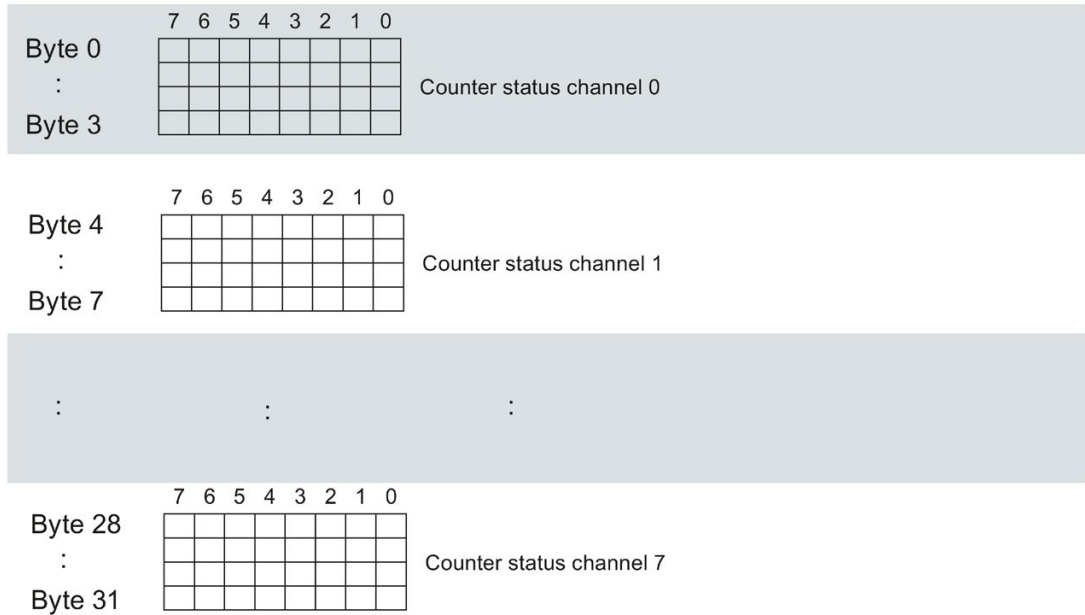

Figure B-2 Structure of data set 129: Byte 0 to 31

B.5 Structure of data set DS 131

Structure of data set 131

The following figure shows you the structure of data set 131.

Enable a parameter by setting the corresponding bit to "1".

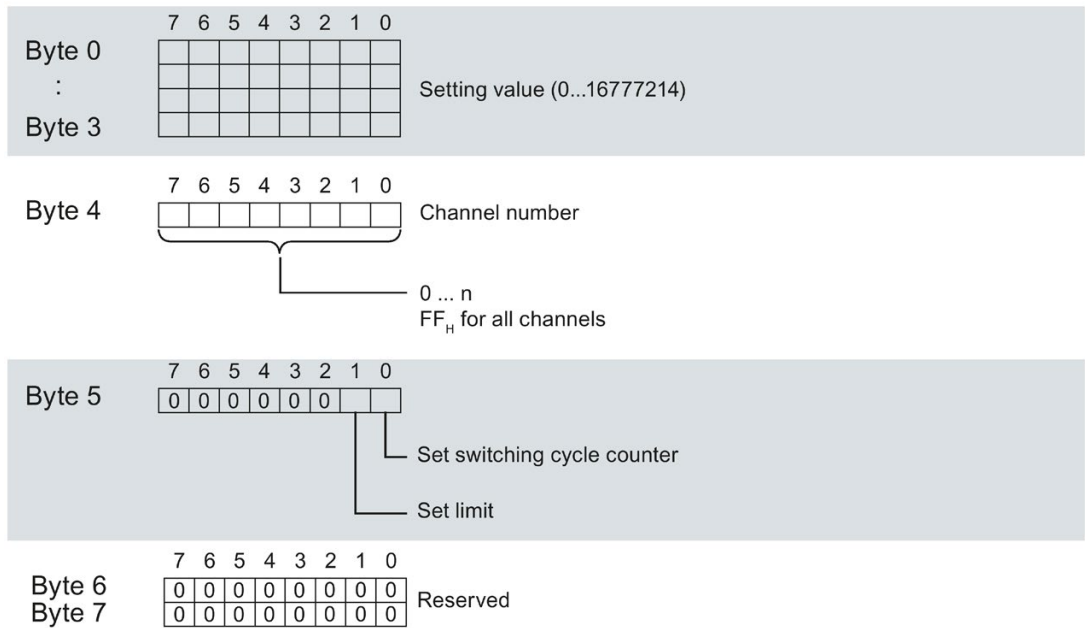

Figure B-4 Structure of data set 131: Bytes 0 to 7