

SIEMENS

Ingenuity for life

Industry Online Support

Home

Creating User-defined Web Pages on S7-1200 / S7-1500

SIMATIC STEP 7 (TIA Portal V14), S7-1200 / S7-1500

<https://support.industry.siemens.com/cs/ww/en/view/68011496>

Siemens
Industry
Online
Support



Warranty and Liability

Note

The Application Examples are not binding and do not claim to be complete regarding the circuits shown, equipping and any eventuality. The Application Examples do not represent customer-specific solutions. They are only intended to provide support for typical applications. You are responsible for ensuring that the described products are used correctly. These Application Examples do not relieve you of the responsibility to use safe practices in application, installation, operation and maintenance. When using these Application Examples, you recognize that we cannot be made liable for any damage/claims beyond the liability clause described. We reserve the right to make changes to these Application Examples at any time without prior notice. If there are any deviations between the recommendations provided in these Application Examples and other Siemens publications – e.g. Catalogs – the contents of the other documents have priority.

We do not accept any liability for the information contained in this document. Any claims against us – based on whatever legal reason – resulting from the use of the examples, information, programs, engineering and performance data etc., described in this Application Example shall be excluded. Such an exclusion shall not apply in the case of mandatory liability, e.g. under the German Product Liability Act (“Produkthaftungsgesetz”), in case of intent, gross negligence, or injury of life, body or health, guarantee for the quality of a product, fraudulent concealment of a deficiency or breach of a condition which goes to the root of the contract (“wesentliche Vertragspflichten”). The damages for a breach of a substantial contractual obligation are, however, limited to the foreseeable damage, typical for the type of contract, except in the event of intent or gross negligence or injury to life, body or health. The above provisions do not imply a change of the burden of proof to your detriment. Any form of duplication or distribution of these Application Examples or excerpts hereof is prohibited without the expressed consent of the Siemens AG.

Security information

Siemens provides products and solutions with industrial security functions that support the secure operation of plants, systems, machines and networks. In order to protect plants, systems, machines and networks against cyber threats, it is necessary to implement – and continuously maintain – a holistic, state-of-the-art industrial security concept. Siemens’ products and solutions only form one element of such a concept.

Customer is responsible to prevent unauthorized access to its plants, systems, machines and networks. Systems, machines and components should only be connected to the enterprise network or the internet if and to the extent necessary and with appropriate security measures (e.g. use of firewalls and network segmentation) in place.

Additionally, Siemens’ guidance on appropriate security measures should be taken into account. For more information about industrial security, please visit <http://www.siemens.com/industrialsecurity>.

Siemens’ products and solutions undergo continuous development to make them more secure. Siemens strongly recommends to apply product updates as soon as available and to always use the latest product versions. Use of product versions that are no longer supported, and failure to apply latest updates may increase customer’s exposure to cyber threats.

To stay informed about product updates, subscribe to the Siemens Industrial Security RSS Feed under <http://www.siemens.com/industrialsecurity>.

Table of Contents

Warranty and Liability	2
1 Preface	4
2 Automation Task	5
3 Automation Solution	6
3.1 General solution overview	6
3.2 Advantages and application options of web server applications.....	7
3.3 Creating user-defined web pages	8
3.4 Structure of the application.....	9
3.5 Hardware and software components	10
4 Principles of Standard Web Pages	12
5 Functional Mechanisms of this Application	13
5.1 Functional principle of the S7 program	13
5.1.1 Startup (OB100)	14
5.1.2 Main (OB1)	14
5.1.3 TankSimu (FB1)	15
5.2 Functional principle of the HTML file	16
5.2.1 AWP commands.....	16
5.2.2 Outputting CPU variables.....	17
5.2.3 Outputting texts via enumerations.....	17
5.2.4 Setting variables in the CPU with value and button	17
5.2.5 Setting variables in the CPU via button only	18
6 Configuration and Settings	19
6.1 Procedure for creating a web page	19
6.2 Configuring the hardware	20
6.3 Creating the variables in the variable table or DB	23
6.4 Creating the HTML files.....	23
6.5 Web server settings and generating of the data blocks	24
6.6 Creating, compiling and loading of the S7 program	26
7 Installation	28
7.1 Hardware and software installation	28
7.2 Installation of the application example	29
8 Operating the Application	30
9 Related Literature	33
9.1 Internet link specifications	33
10 History	34

1 Preface

Objective of the application

The application on hand shows you how to simply and quickly create your own user-defined web pages for S7-1500.

Main topics of this application

The following main points will be discussed in this application:

- Principles of user-defined web pages.
- Creating user-defined web pages.
- Configuring the web server with user-defined web pages.

Advantages

- **Integrated web server**
The standard web pages for simple display of services and diagnostic information are activated with a click. Additionally, individually created, user-defined web pages can be generated.
- **Location-independent**
The web page can be called up world-wide via a standard internet browser.
- **Application example**
Universal usage of the application for all controllers

Benefits

- No additional hardware and software required.
- The access to the web server is possible across large distances via mobile communication devices such as tablet PC, smart phone, etc..
- Reduced working hours through simple activation of the web server.
- Time saving in planning and implementing your automation solution through simple adaptation of the application on hand.

Note

The application example as well as the web server should not and cannot replace an HMI system.

2 Automation Task

Overview of the automation task

Modern automation technology increasingly integrates internet technologies which – together with an integrated Ethernet-based communication – enable, for example, direct access to the system via the intranet.

During the test and commissioning phase, the commissioning engineer wants to have flexible access to the CPU; individual data is to be visualized during operation for diagnostic purposes.

For access mechanisms via the internet or intranet it is reasonable to use already existing standards, such as, for example, http technology, standard web browsers and common "languages" such as HTML (Hypertext Markup Language) or JavaScript.

Figure 2-1 Overview of the automation problem

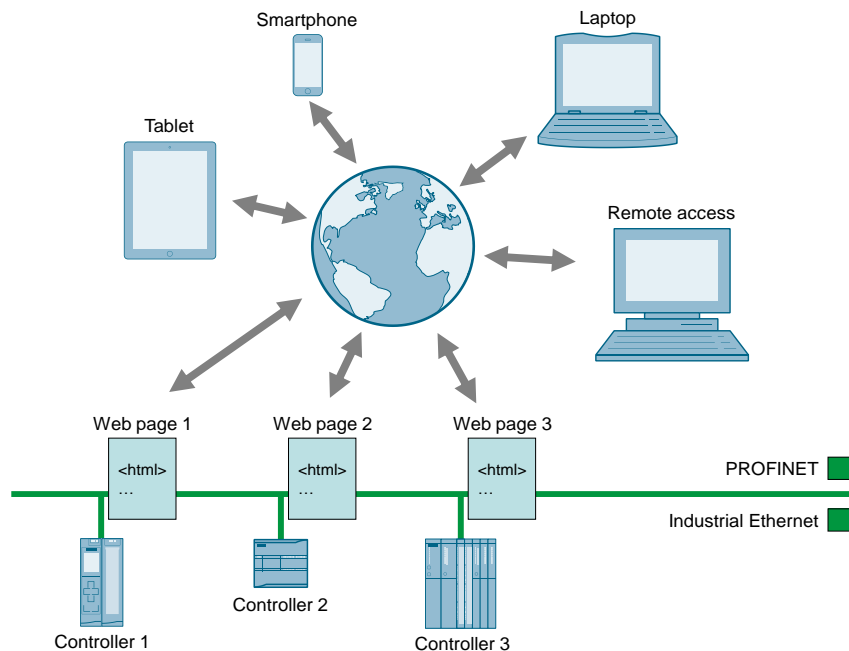

Requirements for the automation task

- Access the CPU with standard hardware and standard mechanisms via Industrial Ethernet. You do not require any additional hardware and software.
- Access the CPU individually related to the system and also visualized, if required. Each CPU has its own individual web page.
- Operating personnel without any automation knowledge is also provided simple access to the CPU.

3 Automation Solution

3.1 General solution overview

Schematic layout

SIMATIC CPUs with PROFINET interfaces provide the opportunity to access CPU variables with the help of web pages provided by the system.

Access the integrated web server of the CPU via a web browser.

The web server contains standard web pages, such as start page, identification, diagnostic buffer, module status, messages, communication, topology and file browser.

In addition to the standard web pages, you can also design and call the web pages individually for your application case.

To create your web page (user-defined web page), you can use any tools such as Microsoft Expression Web, Notepad++, etc.

For designing your web page, you can use all options provided to you by HTML, CSS (Cascading Style Sheets) and JavaScript.

In addition, there are Automation Web Programming (AWP) commands for directed communication with the CPU.

The following figure gives an overview of the implemented solution.

Figure 3-1 Overview of the overall solution

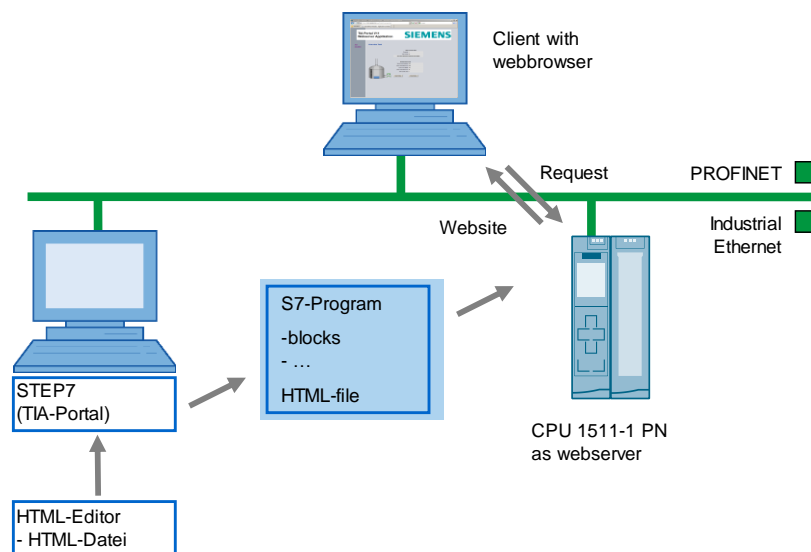

In this application example, the CPU simulates a tank which can be controlled through the website.

3.2 Advantages and application options of web server applications

By having access options through various web browsers, control data can be displayed and to a limited degree controlled, by any computer or web-enabled devices without additional software installation.

Another advantage is the use of the entire network infrastructure of a plant without any additional hardware components. I.e., each place of the plant where a network access is provided, can access the respective controllers.

Evaluating, diagnosing and controlling the controllers can therefore also be performed over large distances or mobile communication devices such as tablet PC, smartphone, etc. However, this also requires you to take corresponding precautions to protect your system. Please observe our security notes in the chapter "[Warranty and Liability](#)" in this context.



WARNING

No safety-relevant functions should be realized via the web server functionality due to the missing time deterministic of web applications!

3.3 Creating user-defined web pages

Below it is shown the procedure for creating user-defined web pages.

Figure 3-2 Procedure at a glance

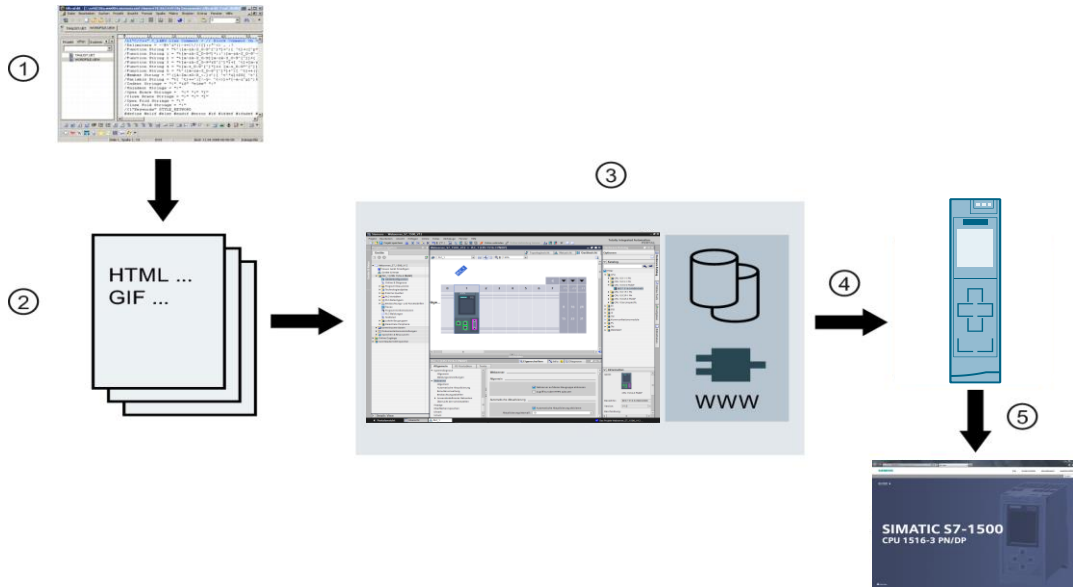

Table 3-1

No.	Instruction
1.	With an HTML editor, you create the HTML file for the user-defined web page.
2.	The web application can consist of various source files, e.g.: *.html, *.gif, *.js, ...
3.	The HTML files with images etc. are stored in data blocks with SIMATIC STEP 7 V12. Call the WWW instruction in the S7 program.
4.	Transfer all blocks to the CPU.
5.	Open the web page of the CPU via a web browser. Accessing the web server of the CPU can be irrespective of the configuration computer. Every output device with access to the PN interface of the CPU can display the web page.

Detailed explanations of the creation of a web page and programming in STEP 7 can be found from Chapter 6 on.

Delimitation

This application is an introduction to user-defined web pages for beginners. Shown are simple methods for accessing the web page of a CPU with HTML and SIMATIC STEP 7 V12.

This application does not include a complete description of HTML. To gain deeper knowledge of HTML and JavaScript, please refer to the literature and internet pages specified in Chapter [9](#).

3.4 Structure of the application

This application was implemented with a CPU 1516-3 PN and a CPU 1214C DC/DC/DC. A PC is connected via the PROFINET interface. The PC serves for the creation of the S7 program and the HTML file, as well as for displaying the web page in a web browser.

Shown are all steps necessary to create a web page and to subsequently call it via the CPU.

Content of the example application

The example application provides the following detailed contents:

- Configuration of the web server for a CPU with PN interface
- Creation of a user-defined web page for the CPU with the following functions:
 - Displaying CPU variables.
 - Graphic display of CPU variables.
 - Setting of CPU variables.
 - Displaying of texts which are linked with CPU variables.
 - Displaying of pictures which are linked with CPU variables.
 - Going to web pages with links in the navigation bar.
 - Cyclic refreshing of the web page with HTML.
- Particularities in the S7 program creation:
 - Providing variables for the web page.
 - Further processing of variables from the web page in the S7 program.

3.5 Hardware and software components

This application was created with the following components.

Hardware components

Note

For this application, you require the current firmware version of the CPU. Depending on the CPU type, the following entries contain links to the corresponding downloads:

- S7-1500: <http://support.automation.siemens.com/WW/view/en/56926947/133200>
- S7-1200: <http://support.automation.siemens.com/WW/view/en/104546617/133200>

Table 3-2

Component	No.	Order number	Note
CPU 1516-3 PN or CPU 1214C DC/DC/DC	1	6ES7511-1AK01-0AB0 6ES7214-1AG40-0XB0	FW 2.0.5 FW 4.2
Optional by using S7-1500: CP 1543-1	1	6GK7 543-1AX00-0XE0	PROFINET CP with firewall functionality for protection against unauthorized network access
PG/PC with Ethernet interface	1	-	-
IE FC TP STANDARD CABLE	1	6XV1840-2AH10	Connecting cable IE; minimum order quantity 20m
RJ45 connector	2	6GK1901-1BB10-2AA0	Can be assembled

Software components

Table 3-3

Component	No.	Order number	Note
SIMATIC STEP 7 Professional V14	1	6ES7822-1AA04-0YE5	V14.0 (Update 2)
Software tool for creating HTML files, e.g. Frontpage, Notepad++, ...	1	-	-
Web browser, e. g. Internet Explorer, Mozilla Firefox ¹⁾	1	-	Application optimized for Internet Explorer 11.0.

¹⁾ The following web browsers were explicitly tested for communication with the CPU:

- Internet Explorer (version 11)
- Mozilla Firefox (version 50.0)

Note

The application is optimized for the Internet Explorer and Firefox.
For the use of other browsers, adjustments may have to be made.

Sample files and projects

The following list includes all files and projects that are used in this example.

Table 3-4

Component	Comments
68011496_S7-1200_S7-1500_Webserver_CODE_v22.zip	The zip file contains the STEP 7 project with the related HTML file. The HTML file with the associated files, are located in the \html directory.
68011496_S7-1200_S7-1500_Webserver_DOC_v22_en.pdf	This document.

4 Principles of Standard Web Pages

Requirements

In STEP 7, the following settings are required in the properties of the PLC:

- The web server must be activated.
- If you require safe access to the standard web pages, enable the "Permit access only with HTTPS" checkbox.
- Automatic refreshing of the standard web pages is enabled. The refresh interval is preset to 10 s and can lie in the range of between 1 to 999.

Access via HTTP or HTTPS

With the URL "http://ww.xx.yy.zz" or "https://ww.xx.yy.zz" you get access to the standard web pages. "ww.xx.yy.zz" corresponds to the IP address of the S7-1500 CPU.

HTTPS is used for the encryption and authentication of the communication between browser and web server. When the "Permit access only with HTTPS" checkbox is enabled, calling the web pages of S7-1500 CPU is only possible via HTTPS.

Log in

The user with the name "Anybody" is the default setting in the user list. This user is given administrative rights, so there is no need for logging in at the webpages.

Hinweis

Further information about the user handling and the integration of the LogIn window in the user defined webpages are described in the „Simple examples of the webserver for SIMATIC S7-1200/S7-1500“.

These examples can be downloaded at the same website like this application.

Standard web pages of SIMATIC S7-1500

The web server of the S7-1500 already offers plenty of information regarding the respective CPU via integrated standard web pages.

A detailed description of the setup of the standard web pages is available in the application description [59193560](#).

5 Functional Mechanisms of this Application

5.1 Functional principle of the S7 program

The S7 program of this application only serves for representing individual functional principles of STEP 7 by way of example.

The call structure in the S7 program looks as follows:

Figure 5-1 Call structure of the S7-program

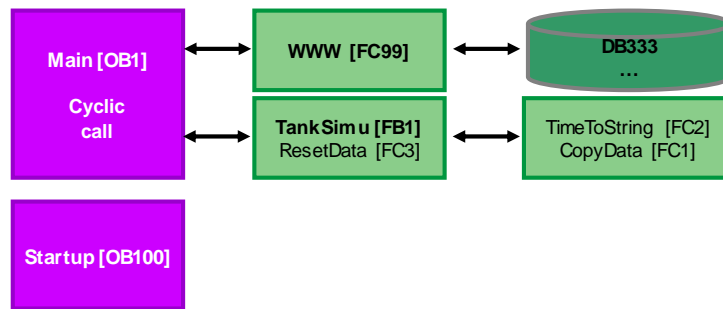

The following symbols and variables are used in the “ **Web2Plc** ” data block:

Figure 5-2 Tag table

Web2Plc		
	Name	Data type
1	Static	
2	tankLevelScale	Int
3	actFlowrate	Int
4	startStop	Bool
5	reset	Bool
6	stop	Bool
7	start	Bool
8	openValve	Bool
9	closeValve	Bool
10	statusValveCPU	Bool
11	flowrate	Int
12	alarm	Int
13	tankLevel	Int
14	tankLevelOverflow	Int
15	tankLevelMaximum	Int
16	tankLevelMidth	Int
17	tankLevelMinimum	Int
18	tankLevelLack	Int
19	Data	Array[1..20] of *typ

5.1.1 Startup (OB100)

In the “**Startup**” (OB100) OB, a start value for the “**Flowrate**” and the limit values for the variables are stored.

5.1.2 Main (OB1)

In OB “**Main**” (OB1) the status of DB333 is polled cyclically to be able to recognize a request from the web browser. The cause for a request is that a variable changed by the user is to be transferred from the web browser to the web server.

Synchronizing user-defined web pages

The “**WWW**” (SFC99) instruction initializes the web server of the CPU. The error information is output via “**RET_VAL**”.

Calling the tank simulation

To ensure that filling or emptying of the tank does not happen too quickly, the “**TankSimu**” function block is called in OB1 only once per second.

Polling the “**Start**” or “**Stop**” and “**Reset**” buttons

The status of the “**Start**” and “**Stop**” buttons are polled by the web page. If one of the buttons has been clicked, the status is stored in the “**startStop**” PLC variable.

In addition the status of the “**Reset**” button is polled.

Polling of the “**OpenValve**” or “**CloseValve**” buttons

The status of the “**OpenValve**” (tank deflates) and “**CloseValve**” (tank closed) buttons is polled by the web page.

If one of the buttons has been clicked, the status is stored in the “**statusValveCPU**” PLC variable.

5.1.3 TankSimu (FB1)

Functionality of the FB1

In FB1, the filling or emptying of a tank is simulated, dependent on the flow rate and the valve position.

The block is only run once every second.

The user can define the flow rate via the “**flowrate**” variable on the web page. The tank filling level is increased or reduced with the flow rate when calling FB1. The current filling level is stored in the “**tankLevel**” PLC variable.

Via the two PLC variables “**openValve**” and “**closeValve**”, the valve position is read in and stored in the CPU in the “**statusValveCPU**” PLC variables.

Dependent on the tank filling level, the following heights are displayed:

- Tank has been fully drained (TankLevelLack)
- Tank filling level is at minimum (TankLevelMinimum)
- Tank filling level is 50 % (TankLevelMidth)
- Tank filling level is at maximum (TankLevelMaximum)
- Tank is overflowing (TankLevelOverflow)

Via the “**alarm**” variable, the tank filling level is output in clear text (also as enumeration)

StartStop status

Only when the “**startStop**” is set, the tank filling level changes and values are entered in the ring buffer.

Valve status

Via the “**statusVentilCPU**” bit, the button pressed last (OpenValve or CloseValve) is memorized.

Dependent on this bit, the tank is either emptied or filled.

Filling the tank

The filling of the tank starts with a query whether the tank is already full.

If the tank is not full, the tank filling level is increased with the flow rate. The tank filling level is limited to the “**tankLevelOverflow**” value.

Emptying the tank

The emptying of the tank is similar to the filling of the tank. The tank filling level is reduced with the flow rate and is limited to 0.

Alarm status

Subsequently, the tank filling level is compared with the specifications for the limit values of the tank filling level.

Depending on the filling level reached, the values "0" to "5" are stored in the “**alarm**” variable. With the value of the “**alarm**” variable, HTML texts (enumerations) are stored, which display the filling level of the tank in clear text.

5.2 Functional principle of the HTML file

The following chapter provides a detailed explanation of the individual sections of the HTML file. For the creation of the HTML pages only fixed values are used for the position and size of the elements. This prevents the elements from moving and overlapping when the browser window is made smaller.

5.2.1 AWP commands

Basics

AWP commands are inserted as HTML comments in HTML files. AWP commands can be located at any position in the HTML file. However, for reasons of clarity it is appropriate to list the central AWP commands at the beginning of the HTML file.

Figure 5-3 AWP commands

```
<!-- AWP_In_Variable Name='Web2Plc'.start' -->
<!-- AWP_In_Variable Name='Web2Plc'.stop' -->
<!-- AWP_In_Variable Name='Web2Plc'.reset' -->
<!-- AWP_In_Variable Name='Web2Plc'.flowrate' -->
```

Explanations

Table 5-1

Code	Explanation
<pre><!-- AWP_In_Variable Name='Web2Plc'.start' --></pre>	<p>All variables transferred to the CPU must be identified as AWP_In_Variable.</p> <p>Note: Keep in mind that the quotation marks are nested. The variable is written between quotation marks and framed by an inverted comma ('...').</p>
<pre><!-- AWP_Enum_Def Name="AlarmValue" Values='0:"Tank empty!", 1:"Tank level below minimum!", 2:"Tank level between minimum and width!", 3:"Tank level between width and maximum!", 4:"Tank level over maximum!", 5:"Tank level overflow!"' --></pre>	<p>ENUM types are defined with AWP_Enum_Def.</p>
<pre><!-- AWP_Enum_Ref Name='Alarm' Enum="AlarmValue" -- >:="Alarm":</pre>	<p>The ENUM types are assigned to variables with AWP_Enum_Ref.</p>

5.2.2 Outputting CPU variables

Explanations

Variables of the CPU are always displayed via the symbol name:

Figure 5-4 Representation of tags in the HTML file

```
<td class="output_field">:= "Web2Plc".tankLevel:</td>
```

Instead of := "Web2Plc".tankLevel:, always the current value from the CPU is output on the web page.

5.2.3 Outputting texts via enumerations

Explanations

Via enumerations, texts can be allocated to the individual values of a CPU variable.

Figure 5-5 Representation of enumerations in the HTML file

```
<!-- AWP_Enum_Ref Name=' "Web2Plc".alarm' Enum="AlarmValue" -->:= "Web2Plc".alarm:
```

Instead of the individual values of "Alarm", the previously assigned texts in HTML are output. These texts stored as enum-type "AlarmValue" and are transferred to the web page via DB333.

5.2.4 Setting variables in the CPU with value and button

Basics

To be able to transfer variables to the CPU via the web page, you have to work with forms and, for example, the "POST" method.

Explanations

Abbildung 5-6 Representation of entries in the HTML file

```
<form method="post" action="">
  <input type="number" min="1" max="10" id="wert1" name=' "Web2Plc".flowrate' size="2"
    style="height: 45px; width: 50px; font-size: 21px; text-align: center; padding: 8px;">
  <input type="submit" value="Set a new Flowrate" style="height: 45px; width: 200px">
</form>
```

Table 5-2

Code	Explanation
<pre><form method="post" action=""> <input type="number" min="1" max="10" id="wert1" name=' "Web2Plc".flowrate' size="2" style="height: 45px; width: 50px; font-size: 21px; text-align: center; padding: 8px;"> <input type="submit" value="Set a new Flowrate" style="height: 45px; width: 200px"> </form></pre>	<p>Calling the form with the <code>post</code> method. Under <code>action</code>, no details are required since with <code>action</code> the current page is called by default.</p> <p>If the input with the type <code>submit</code> is activated the content is transferred to the CPU.</p>

5.2.5 Setting variables in the CPU via button only

Basics

To assign variables in the CPU a predefined value, you have to work with a form, the "POST" method and a hidden value.

Explanations

Figure 5-7 Representation of buttons in the HTML file

```
<td width="144px" height="21px">
  <form method="post" action="">
    <input type="submit" value="OpenValve">
    <input type="hidden" name="OpenValve" size="20px" value="1">
    <input type="hidden" name="CloseValve" size="20px" value="0">
  </form>
</td>

<td width="144px" height="21px">
  <form method="post" action="">
    <input type="submit" value="CloseValve">
    <input type="hidden" name="CloseValve" size="20px" value="1">
    <input type="hidden" name="OpenValve" size="20px" value="0">
  </form>
</td>
```

Table 5-3

Code	Explanation
<pre><form method="post" action=""> <input type="submit" value="OpenValve"> <input type="hidden" name="OpenValve" size="20px" value="1"> <input type="hidden" name="CloseValve" size="20px" value="0"> </form></pre>	<p>Calling the form with the <code>post</code> method. Under <code>action</code>, no details are required since with <code>action</code> the current page is called by default.</p> <p>With <code>input type="hidden"</code>, the "OpenValve" variable is assigned the value 1, the "CloseValve" variable the value 0.</p> <p>With <code>submit</code>, the values of the variables are sent to the web server of the CPU.</p>
<pre><form method="post" action=""> <input type="submit" value="CloseValve"> <input type="hidden" name="CloseValve" size="20px" value="1"> <input type="hidden" name="OpenValve" size="20px" value="0"> </form></pre>	<p>Reverse action to the row above: calling the form to assign the value 1 to "CloseValve" and the value 0 to "OpenValve".</p>

6 Configuration and Settings

This chapter contains all information on how you can create and operate a web page for a CPU with PN interface for yourself. The CPU 1516-3 PN/DP is used as an example in this Section. All steps are presented by means of the completed example application.

If you just want to take the completed example application into operation, please continue reading in Chapter [7](#).

6.1 Procedure for creating a web page

The configuration and settings in STEP 7 and the writing of the HTML file are closely linked. The following procedure is recommendable for that:

1. [Configuring the hardware](#)
2. [Creating the variables in the S7 program](#)
3. [Creating the HTML files](#)
4. [Web server settings and generating of the data blocks](#)
5. [Creating, compiling and loading of the S7 program](#)

6.2 Configuring the hardware

Table 6-1

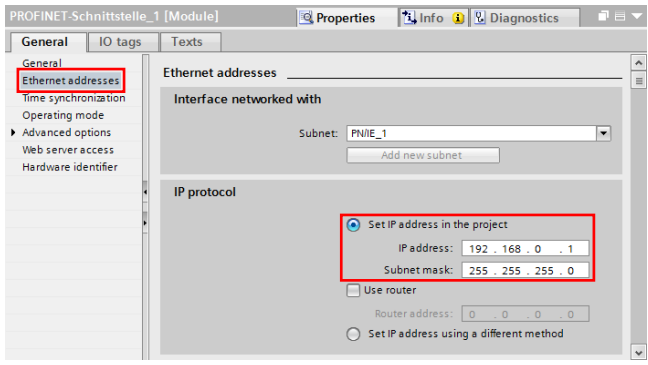
No.	Action	Comment
1.	Start the STEP 7 TIA Portal and create a new project named "Webserver_S7_1500" oder "Webserver_S7_1200" via "Project > New...".	-
2.	Click "Add new device" >> "PLC > SIMATIC S7-1500/1200" to add an S7-1500 or S7-1200 station. The device view of the PLC opens.	-
3.	Click the "Add new subnet" button in the properties of the Ethernet interface.	
4.	Assign the IP address 192.168.0.1 of the CPU to the Ethernet interface. Via this IP address, you will later access the web page of the CPU with your web browser.	
The following steps optionally add safety when using an S7-1500.		
5.	Insert module "Communication modules >> PROFINET/Ethernet >> CP 1543-1 >> 6GK7 543-1AX00-0XE0" from the hardware catalog.	-

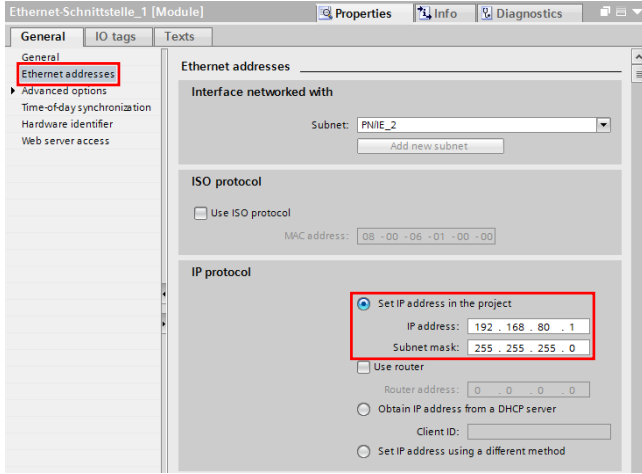
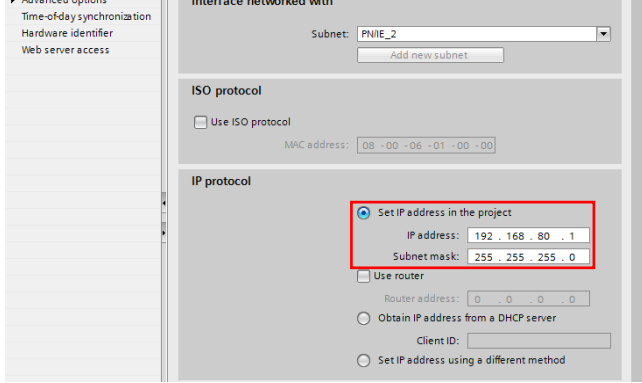
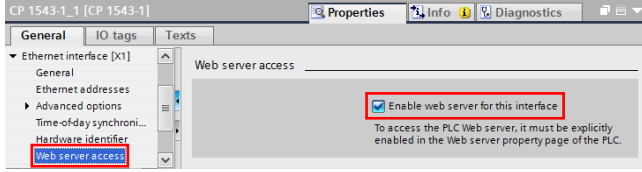
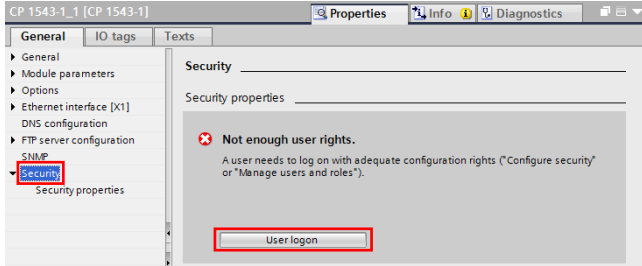
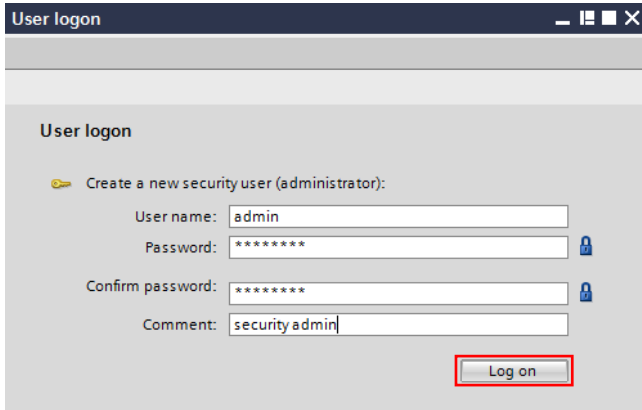
No.	Action	Comment
6.	Click the “Add new subnet” button in the properties of the Ethernet interface of the CP.	
7.	Assign the IP address “192.168.80.1” of the CP to the Ethernet interface. Via this IP address, you can later also access the web page of the CPU with your web browser.	
8.	Click on “Web server access” in the Properties of the Ethernet interface of the CP. Activate "Enable web server for this interface"	
9.	In the properties of the CP you click on “Security”. Click on “User logon”. Configuring the “Security” is only possible after a user with the appropriate configuration rights has logged on.	
10.	In the Security user management you create a new user with Administrator rights, such as: User name: “admin” Password: “Security” Confirm your entries with “Log on”.	

6 Configuration and Settings

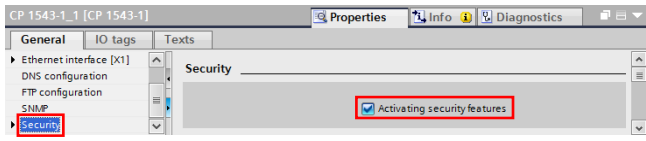
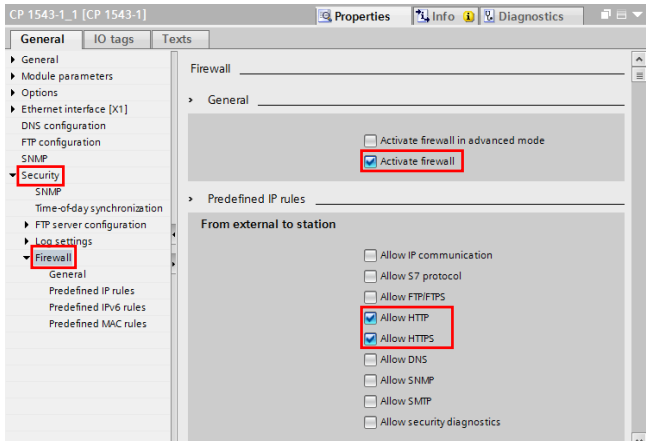
No.	Action	Comment
11.	Refresh the Properties of the CP. Enable "Activating security features".	
12.	Open the "Security" area and select "Firewall". Enable the following: <ul style="list-style-type: none"> • "Activate firewall" • "Allow HTTP" • "Allow HTTPS" 	

6.3 Creating the variables in the variable table or DB

Table 6-2

No.	Action	Comment																																																												
13.	Create a DB (Program blocks -> Add new block -> DB) or a tag table (PLC tags -> Add new tag table) and insert the desired tags.	<table border="1"> <thead> <tr> <th colspan="3">Web2Plc</th> </tr> <tr> <th></th> <th>Name</th> <th>Data type</th> </tr> </thead> <tbody> <tr> <td>1</td> <td>Static</td> <td></td> </tr> <tr> <td>2</td> <td>tankLevelScale</td> <td>Int</td> </tr> <tr> <td>3</td> <td>actFlowrate</td> <td>Int</td> </tr> <tr> <td>4</td> <td>startStop</td> <td>Bool</td> </tr> <tr> <td>5</td> <td>reset</td> <td>Bool</td> </tr> <tr> <td>6</td> <td>stop</td> <td>Bool</td> </tr> <tr> <td>7</td> <td>start</td> <td>Bool</td> </tr> <tr> <td>8</td> <td>openValve</td> <td>Bool</td> </tr> <tr> <td>9</td> <td>closeValve</td> <td>Bool</td> </tr> <tr> <td>10</td> <td>statusValveCPU</td> <td>Bool</td> </tr> <tr> <td>11</td> <td>flowrate</td> <td>Int</td> </tr> <tr> <td>12</td> <td>alarm</td> <td>Int</td> </tr> <tr> <td>13</td> <td>tankLevel</td> <td>Int</td> </tr> <tr> <td>14</td> <td>tankLevelOverflow</td> <td>Int</td> </tr> <tr> <td>15</td> <td>tankLevelMaximum</td> <td>Int</td> </tr> <tr> <td>16</td> <td>tankLevelMidth</td> <td>Int</td> </tr> <tr> <td>17</td> <td>tankLevelMinimum</td> <td>Int</td> </tr> <tr> <td>18</td> <td>tankLevelLack</td> <td>Int</td> </tr> </tbody> </table>	Web2Plc				Name	Data type	1	Static		2	tankLevelScale	Int	3	actFlowrate	Int	4	startStop	Bool	5	reset	Bool	6	stop	Bool	7	start	Bool	8	openValve	Bool	9	closeValve	Bool	10	statusValveCPU	Bool	11	flowrate	Int	12	alarm	Int	13	tankLevel	Int	14	tankLevelOverflow	Int	15	tankLevelMaximum	Int	16	tankLevelMidth	Int	17	tankLevelMinimum	Int	18	tankLevelLack	Int
Web2Plc																																																														
	Name	Data type																																																												
1	Static																																																													
2	tankLevelScale	Int																																																												
3	actFlowrate	Int																																																												
4	startStop	Bool																																																												
5	reset	Bool																																																												
6	stop	Bool																																																												
7	start	Bool																																																												
8	openValve	Bool																																																												
9	closeValve	Bool																																																												
10	statusValveCPU	Bool																																																												
11	flowrate	Int																																																												
12	alarm	Int																																																												
13	tankLevel	Int																																																												
14	tankLevelOverflow	Int																																																												
15	tankLevelMaximum	Int																																																												
16	tankLevelMidth	Int																																																												
17	tankLevelMinimum	Int																																																												
18	tankLevelLack	Int																																																												

6.4 Creating the HTML files

To create the HTML file, you need the list of variables from chapter [6.3](#), and a respective editor.

Convenient editors such as Microsoft Expression Web are recommendable, which automatically create tags or mark correct inputs in color already during creation, or simple editors such as Notepad++.

Table 6-3

No.	Action	Comment
1.	Create the HTML files with an editor. Save the HTML files with the required images, style sheets and scripts in the "\html" directory.	Detailed information on the creation of the HTML file can be found in chapter 5.2 .

6.5 Web server settings and generating of the data blocks

Table 6-4

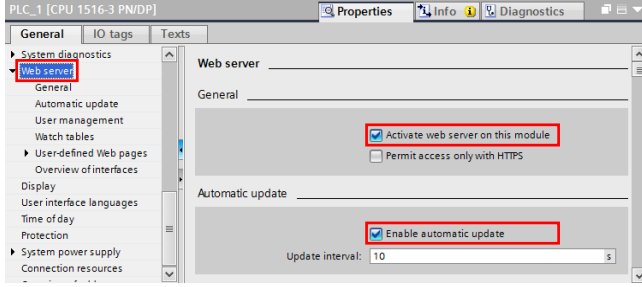
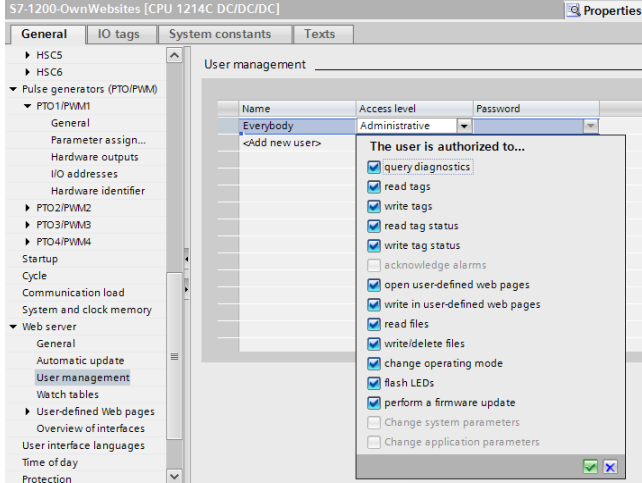
No.	Action	Comment
1.	<p>Click “Web server” in the properties of the PLC. Activate the option box “Activate web server on this module” and “Enable automatic update”.</p> <p>If you require safe access to the standard web pages, enable the “Permit access only with HTTPS” checkbox.</p>	
2.	<p>Select for the user “everybody” all rights. Alternatively you define an own user.</p>	

6 Configuration and Settings

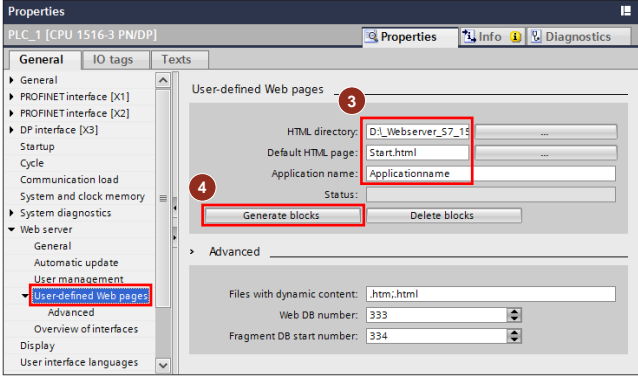
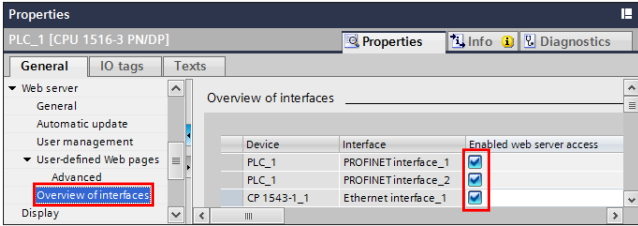
No.	Action	Comment												
3.	Enter the HTML directory of your HTML files and select a start HTML page from the directory. Assign a name to the application (e.g. "Applicationname").													
4.	<p>Generate the Web_Control_DB (default: DB333) and the Fragment_DBs (default: from DB334), by clicking "Generate blocks".</p> <p>Note: STEP 7 verifies the project with regard to the variables, loads the complementary files, such as, for example, the enumerations or images, reads in the variables of the HTML file, verifies the fragments, and writes all data in DB333 and from DB334. The status of the generation is displayed in an independent window or in the inspector window under info.</p>													
5.	Enable the interfaces which shall provide access to the web server.	 <table border="1" data-bbox="927 1205 1353 1294"> <thead> <tr> <th>Device</th> <th>Interface</th> <th>Enabled web server access</th> </tr> </thead> <tbody> <tr> <td>PLC_1</td> <td>PROFINET interface_1</td> <td><input checked="" type="checkbox"/></td> </tr> <tr> <td>PLC_1</td> <td>PROFINET interface_2</td> <td><input checked="" type="checkbox"/></td> </tr> <tr> <td>CP 1543-1_1</td> <td>Ethernet interface_1</td> <td><input checked="" type="checkbox"/></td> </tr> </tbody> </table>	Device	Interface	Enabled web server access	PLC_1	PROFINET interface_1	<input checked="" type="checkbox"/>	PLC_1	PROFINET interface_2	<input checked="" type="checkbox"/>	CP 1543-1_1	Ethernet interface_1	<input checked="" type="checkbox"/>
Device	Interface	Enabled web server access												
PLC_1	PROFINET interface_1	<input checked="" type="checkbox"/>												
PLC_1	PROFINET interface_2	<input checked="" type="checkbox"/>												
CP 1543-1_1	Ethernet interface_1	<input checked="" type="checkbox"/>												

6.6 Creating, compiling and loading of the S7 program

An exemplary S7 program can be found in the appendix to this entry. The following aspects must be considered when creating the S7 program:

- Call the "WWW" (SFC99) instruction. The "WWW" instruction initializes the web server of the CPU. With the cyclic calling of the "WWW" instruction, you ensure that changed variables of the CPU can be displayed on the web page. The cyclic calling of the "WWW" instruction is done in OB1.
- Enter the number of the web control DB (e.g. 333) at the CTRL_DB input parameter of the "WWW" instruction.

Table 6-5

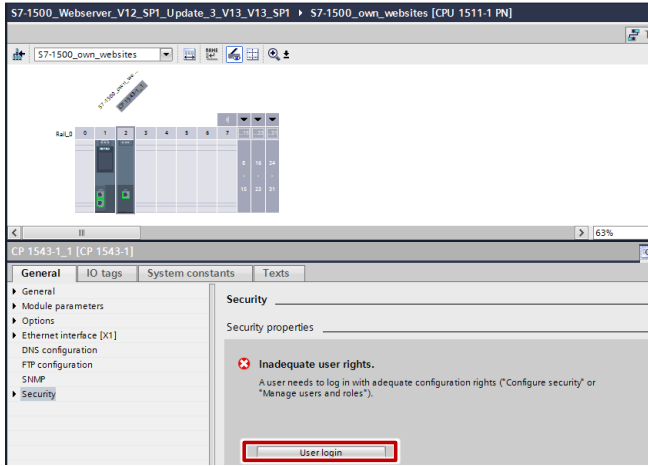
No.	Action	Comment
1.	If you are using a CP module, you have to log on to it first. (Device configuration -> CP-Modul -> Properties -> Security -> User login)	
2.	Compiling Use the mouse to right-click on the CPU 1516-3 PN/DP and select "Compile > Hardware and software (only changes)".	-

6 Configuration and Settings

No.	Action	Comment
3.	<p>Loading project Right-click on the CPU 1516-3 PN/DP and select "Download to device > Hardware and software (only changes)". Set your PG/PC interface in the dialog window as follows:</p> <ul style="list-style-type: none">• PN/IE• <Network card>• (local) PN/IE <p>Select CPU 1516-3 PN/DP and then click on "Load".</p>	<p>The dialog window for setting the PG/PC interface is only displayed during the first loading.</p>

Note

If you want to use a different CPU, you have to exchange the CPU under "Devices & Networks".

7 Installation

7.1 Hardware and software installation

Hardware installation

The figure below shows the hardware configuration of the sample application. The PC with the web browser must be connected to the CPU via Industrial Ethernet, e.g.

- directly at the PN interface of the CPU.
- directly at communication module CP 1543-1.
- via a switch.

Figure 7-1: Hardware configuration of the sample application

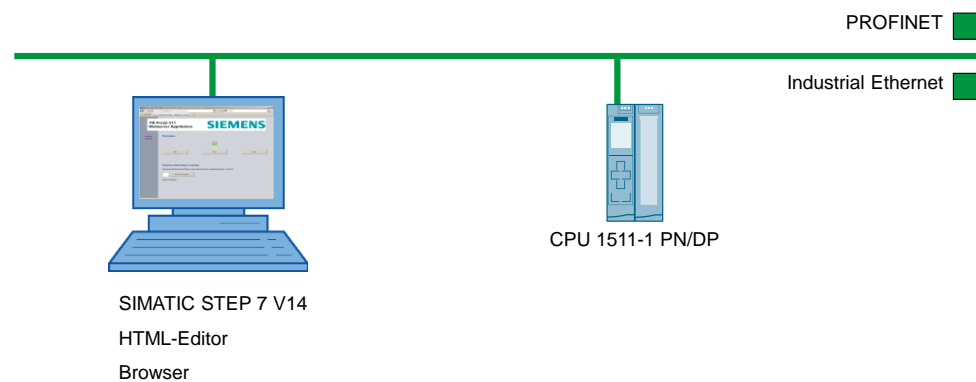

Note

Please observe the installation and connection guidelines from the corresponding manuals.

Installation of the software

Table 7-1

No.	Action	Comment
1.	Install STEP 7	-
2.	Install a tool for creating the web page, e.g. MS Frontpage or Notepad++ on the PC with which you want to create the web page.	-
3.	Install a web browser on the PC, e.g. Firefox or Internet Explorer, with which you want to access the website of the CPU.	-

7.2 Installation of the application example

Table 7-2

No.	Action	Comment
1.	Unzip the "68011496_S7_1200_S7-1500_Webserver_CODE_v22.zip" file in your project directory.	-
2.	Start SIMATIC STEP 7.	-
3.	Open the project in SIMATIC STEP 7.	-
4.	Go to the device view.	-
5.	If you are using a different CPU, change the device.	-
6.	In the CPU properties, assign the IP address of your CPU to the Ethernet interface.	Information in Section 6.2
7.	Using S7-1500 with CP: Log on in the CP properties at Security (User name: admin, Password: Security).	-
8.	Select the S7-1500 and load the entire project in the CPU.	-
9.	Start a web browser and call the web page of your CPU via the IP address.	Information in Section 8



8 Operating the Application

In this chapter

This chapter provides information on how to operate the example application.

Operation

Table 8-1

No.	Action	Comment
1.	<ul style="list-style-type: none"> Start a web browser, e.g. the Internet Explorer. Enter the IP address of the CPU as the address, e.g. http://192.168.0.1 or of the CP http://192.168.80.1. The intro web page of the CPU is opened. Click on "ENTER". 	
2.	Click "Customer pages" to go to the user-defined web page.	

8 Operating the Application

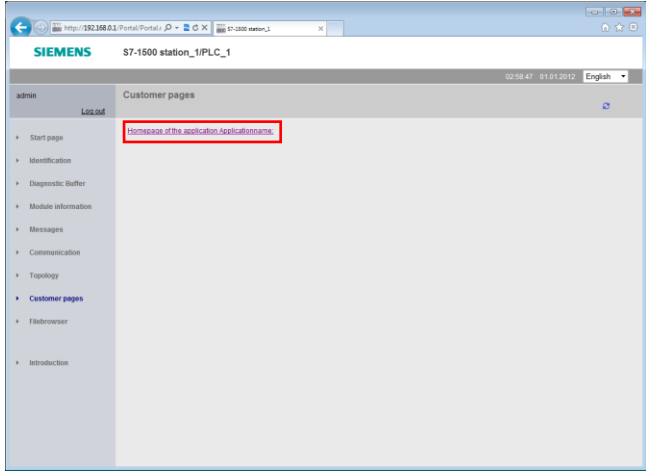
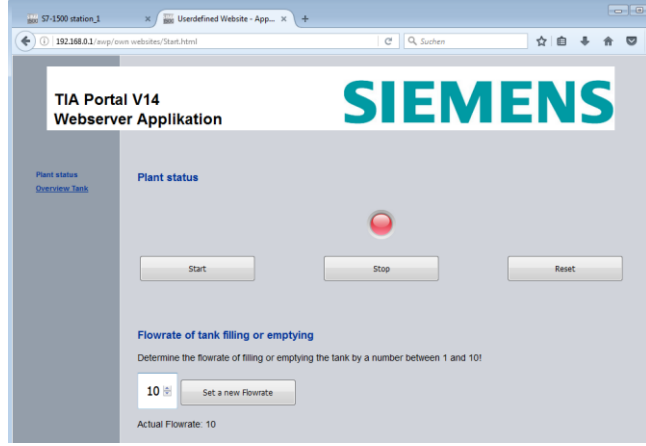
No.	Action	Comment
3.	<p>To start the example application, click on "Homepage of the application". The "Start" web page opens.</p>	
4.	<p>Via the web pages, you have direct access to the CPU: Plant Status web page:</p> <ul style="list-style-type: none"> • Start the application by clicking the "Start" button. • By clicking "Stop", the application is stopped. • The "Reset" button sets the application back into its original state. • The operating status of the application is displayed via the LED (red: off; green: on) • The flow rate can be entered manually. In the S7 program, a medium flow rate of 5 is preset. The higher the value for "Flowrate" is set, the faster the flow rate. • Via the links on the navigation bar, you can switch between the web pages. 	

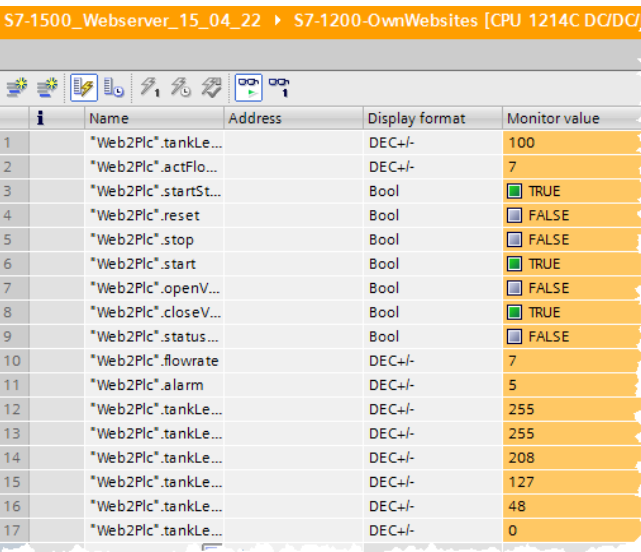
No.	Action	Comment																																																																																										
5.	<p>Tank overview web page:</p> <ul style="list-style-type: none"> • Via “TankLevel” you can see the current filling level of the tank. Additionally, the filling level is commented via clear text. • The limits of the filling levels are displayed underneath. • When clicking the “OpenValve” button, the tank is emptied. • The valve is closed via “CloseValve” – the tank is filled again. • Valve green: open Valve red: closed • The web page is automatically refreshed and the values are adjusted. <p>Via the links on the navigation bar, you can switch between the web pages.</p>																																																																																											
6.	<p>In parallel, you can monitor the change of the variables in the watch table in STEP 7.</p>	 <table border="1"> <thead> <tr> <th></th> <th>Name</th> <th>Address</th> <th>Display format</th> <th>Monitor value</th> </tr> </thead> <tbody> <tr><td>1</td><td>*Web2Plc*.tankLe...</td><td></td><td>DEC+/-</td><td>100</td></tr> <tr><td>2</td><td>*Web2Plc*.actFlo...</td><td></td><td>DEC+/-</td><td>7</td></tr> <tr><td>3</td><td>*Web2Plc*.startSt...</td><td></td><td>Bool</td><td>TRUE</td></tr> <tr><td>4</td><td>*Web2Plc*.reset</td><td></td><td>Bool</td><td>FALSE</td></tr> <tr><td>5</td><td>*Web2Plc*.stop</td><td></td><td>Bool</td><td>FALSE</td></tr> <tr><td>6</td><td>*Web2Plc*.start</td><td></td><td>Bool</td><td>TRUE</td></tr> <tr><td>7</td><td>*Web2Plc*.openV...</td><td></td><td>Bool</td><td>FALSE</td></tr> <tr><td>8</td><td>*Web2Plc*.closeV...</td><td></td><td>Bool</td><td>TRUE</td></tr> <tr><td>9</td><td>*Web2Plc*.status...</td><td></td><td>Bool</td><td>FALSE</td></tr> <tr><td>10</td><td>*Web2Plc*.flowrate</td><td></td><td>DEC+/-</td><td>7</td></tr> <tr><td>11</td><td>*Web2Plc*.alarm</td><td></td><td>DEC+/-</td><td>5</td></tr> <tr><td>12</td><td>*Web2Plc*.tankLe...</td><td></td><td>DEC+/-</td><td>255</td></tr> <tr><td>13</td><td>*Web2Plc*.tankLe...</td><td></td><td>DEC+/-</td><td>255</td></tr> <tr><td>14</td><td>*Web2Plc*.tankLe...</td><td></td><td>DEC+/-</td><td>208</td></tr> <tr><td>15</td><td>*Web2Plc*.tankLe...</td><td></td><td>DEC+/-</td><td>127</td></tr> <tr><td>16</td><td>*Web2Plc*.tankLe...</td><td></td><td>DEC+/-</td><td>48</td></tr> <tr><td>17</td><td>*Web2Plc*.tankLe...</td><td></td><td>DEC+/-</td><td>0</td></tr> </tbody> </table>		Name	Address	Display format	Monitor value	1	*Web2Plc*.tankLe...		DEC+/-	100	2	*Web2Plc*.actFlo...		DEC+/-	7	3	*Web2Plc*.startSt...		Bool	TRUE	4	*Web2Plc*.reset		Bool	FALSE	5	*Web2Plc*.stop		Bool	FALSE	6	*Web2Plc*.start		Bool	TRUE	7	*Web2Plc*.openV...		Bool	FALSE	8	*Web2Plc*.closeV...		Bool	TRUE	9	*Web2Plc*.status...		Bool	FALSE	10	*Web2Plc*.flowrate		DEC+/-	7	11	*Web2Plc*.alarm		DEC+/-	5	12	*Web2Plc*.tankLe...		DEC+/-	255	13	*Web2Plc*.tankLe...		DEC+/-	255	14	*Web2Plc*.tankLe...		DEC+/-	208	15	*Web2Plc*.tankLe...		DEC+/-	127	16	*Web2Plc*.tankLe...		DEC+/-	48	17	*Web2Plc*.tankLe...		DEC+/-	0
	Name	Address	Display format	Monitor value																																																																																								
1	*Web2Plc*.tankLe...		DEC+/-	100																																																																																								
2	*Web2Plc*.actFlo...		DEC+/-	7																																																																																								
3	*Web2Plc*.startSt...		Bool	TRUE																																																																																								
4	*Web2Plc*.reset		Bool	FALSE																																																																																								
5	*Web2Plc*.stop		Bool	FALSE																																																																																								
6	*Web2Plc*.start		Bool	TRUE																																																																																								
7	*Web2Plc*.openV...		Bool	FALSE																																																																																								
8	*Web2Plc*.closeV...		Bool	TRUE																																																																																								
9	*Web2Plc*.status...		Bool	FALSE																																																																																								
10	*Web2Plc*.flowrate		DEC+/-	7																																																																																								
11	*Web2Plc*.alarm		DEC+/-	5																																																																																								
12	*Web2Plc*.tankLe...		DEC+/-	255																																																																																								
13	*Web2Plc*.tankLe...		DEC+/-	255																																																																																								
14	*Web2Plc*.tankLe...		DEC+/-	208																																																																																								
15	*Web2Plc*.tankLe...		DEC+/-	127																																																																																								
16	*Web2Plc*.tankLe...		DEC+/-	48																																																																																								
17	*Web2Plc*.tankLe...		DEC+/-	0																																																																																								

9 Related Literature

9.1 Internet link specifications

This table contains a selection of links on further information.

Table 9-1

	Topic
/1/	Link to this document https://support.industry.siemens.com/cs/ww/en/view/68011496
/2/	Siemens Industry Online Support http://support.automation.siemens.com
/3/	HTML5, JavaScript http://www.w3schools.com/html/ http://www.w3schools.com/js/
/4/	SIMATIC S7 S7-1200 Programmable controller https://support.industry.siemens.com/cs/ww/en/view/109741593
/5/	S7-1500 Web server function manual http://support.automation.siemens.com/WW/view/en/59193560
/6/	S7-1500 System Manual http://support.automation.siemens.com/WW/view/en/59191792
/7/	Simple Examples for the webserver https://support.industry.siemens.com/cs/ww/en/view/68011496
/8/	SIMATIC STEP 7 Professional V14.0 https://support.industry.siemens.com/cs/ww/en/view/109742272

10 History

Table 10-1

Version	Date	Modifications
V1.0	02/2014	First version
V2.0	06/2015	The applications "Creating and using user-defined web pages on S7-1200" and "Creating and using user-defined web pages on S7-1500" were merged.
V2.1	10/2015	correction
V2.2	10/2016	The application is completely programmed with HTML. HTML5 is used.