

**SIEMENS**



Application example • 03/2017

# Closed-Loop Control with "PID\_Compact" V2.3

SIMATIC S7-1500



<https://support.industry.siemens.com/cs/ww/en/view/79047707>

## Warranty and liability

### Note

The Application Examples are not binding and do not claim to be complete regarding the circuits shown, equipping and any eventuality. The Application Examples do not represent customer-specific solutions. They are only intended to provide support for typical applications. You are responsible for ensuring that the described products are used correctly. These Application Examples do not relieve you of the responsibility to use safe practices in application, installation, operation and maintenance. When using these Application Examples, you recognize that we cannot be made liable for any damage/claims beyond the liability clause described. We reserve the right to make changes to these Application Examples at any time without prior notice.

If there are any deviations between the recommendations provided in these Application Examples and other Siemens publications – e.g. Catalogs – the contents of the other documents have priority.

We do not accept any liability for the information contained in this document. Any claims against us – based on whatever legal reason – resulting from the use of the examples, information, programs, engineering and performance data etc., described in this Application Example shall be excluded. Such an exclusion shall not apply in the case of mandatory liability, e.g. under the German Product Liability Act (“Produkthaftungsgesetz”), in case of intent, gross negligence, or injury of life, body or health, guarantee for the quality of a product, fraudulent concealment of a deficiency or breach of a condition which goes to the root of the contract (“wesentliche Vertragspflichten”). The damages for a breach of a substantial contractual obligation are, however, limited to the foreseeable damage, typical for the type of contract, except in the event of intent or gross negligence or injury to life, body or health. The above provisions do not imply a change of the burden of proof to your detriment.

Any form of duplication or distribution of these Application Examples or excerpts hereof is prohibited without the expressed consent of the Siemens AG.

### Security information

Siemens provides products and solutions with industrial security functions that support the secure operation of plants, systems, machines and networks. In order to protect plants, systems, machines and networks against cyber threats, it is necessary to implement – and continuously maintain – a holistic, state-of-the-art industrial security concept. Siemens’ products and solutions only form one element of such a concept.

Customer is responsible to prevent unauthorized access to its plants, systems, machines and networks. Systems, machines and components should only be connected to the enterprise network or the internet if and to the extent necessary and with appropriate security measures (e.g. use of firewalls and network segmentation) in place.

Additionally, Siemens’ guidance on appropriate security measures should be taken into account. For more information about industrial security, please visit <http://www.siemens.com/industrialsecurity>.

Siemens’ products and solutions undergo continuous development to make them more secure. Siemens strongly recommends to apply product updates as soon as available and to always use the latest product versions. Use of product versions that are no longer supported, and failure to apply latest updates may increase customer’s exposure to cyber threats.

To stay informed about product updates, subscribe to the Siemens Industrial Security RSS Feed under <http://www.siemens.com/industrialsecurity>.

# Table of contents

<b>Warranty and liability</b> .....	<b>2</b>
<b>1 Task</b> .....	<b>4</b>
1.1 Introduction.....	4
1.2 Overview of the automation task.....	4
<b>2 Solution</b> .....	<b>5</b>
2.1 Solution overview .....	5
2.2 Scenarios of the application .....	6
2.3 Visualization user interface .....	7
2.4 Hardware and software components .....	7
2.4.1 Validity.....	7
2.4.2 Components used .....	7
<b>3 Basics of Control Engineering</b> .....	<b>9</b>
<b>4 Function mechanisms</b> .....	<b>11</b>
4.1 Structure of the sample project .....	11
4.2 Scenario 1: Calling and commissioning "PID_Compact" .....	13
4.2.1 Task: Control a simulated PT3 system .....	13
4.2.2 Procedure .....	14
4.2.3 Controlled system: Scenario1 .....	14
4.3 Scenario 2: Simulation and closed-loop control of a more complex controlled system .....	16
4.3.1 Task: Control a simulated more complex controlled system.....	16
4.3.2 Procedure .....	17
<b>5 Configuration and Programming</b> .....	<b>19</b>
5.1 Inserting FB "PID_Compact" (FB1130).....	20
5.2 Parameterizing FB "PID_Compact" (FB1130).....	22
5.3 Commissioning FB "PID_Compact" (FB1130) .....	24
5.3.1 Commissioning with pretuning and fine tuning .....	24
5.3.2 Commissioning with specified PID parameters.....	26
5.4 Inserting a function block of the simulation library .....	28
5.5 Simulation of a controlled system with multiple elements.....	29
<b>6 Installation and Startup</b> .....	<b>32</b>
6.1 Startup with the entire hardware .....	32
6.1.1 Installing the hardware .....	32
6.1.2 Installing the software.....	33
6.1.3 Configuring the hardware .....	34
6.1.4 Opening and downloading the TIA Portal project .....	35
6.2 Startup with PLCSIM V13.....	36
6.2.1 Installing the software.....	36
6.2.2 Configuring the engineering station .....	36
6.2.3 Opening and downloading the TIA Portal project .....	38
<b>7 Operation of the application</b> .....	<b>39</b>
7.1 Overview.....	39
7.2 Operation via WinCC Runtime .....	39
7.2.1 Control elements .....	39
7.2.2 Monitoring Scenario 2 with WinCC .....	41
7.3 Operator control and monitoring via online access .....	42
<b>8 Related literature</b> .....	<b>43</b>
<b>9 History</b> .....	<b>43</b>

# 1 Task

## 1.1 Introduction

Influencing technical variables in systems requires controlling these variables. In automation technology, controllers are used in many different ways, for example for temperature control in processes.

In the SIMATIC world, the "PID\_Compact" block, version 2.3, is provided for the S7-1500 CPUs for closed-loop process control.

## 1.2 Overview of the automation task

The automation task is to set up a control loop for influencing physical parameters in a technical process. The control loop is to consist of the following elements:

- "PID\_Compact" as the controller.
- Simulated technical processes as the controlled system.

Figure 1-1

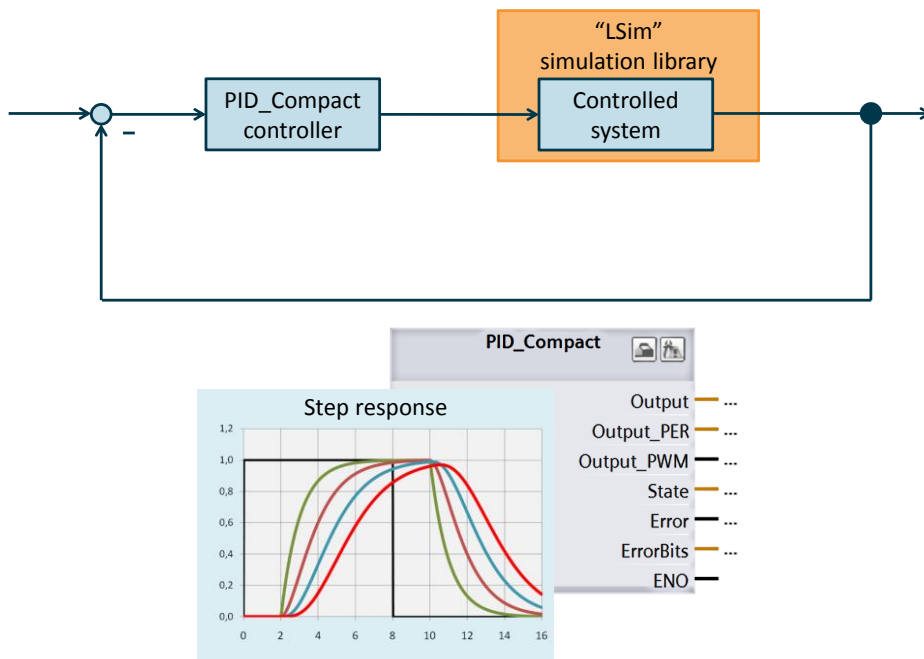

The application must meet the following requirements:

- Explain the configuration and parameterization of the software controller ("PID\_Compact" block).
- Show options for optimizing "PID\_Compact".
- Show the use of the "LSim" simulation library and the simulation of technical processes.

## 2 Solution

### 2.1 Solution overview

#### Display

The following figure displays the most important components of the solution:

Figure 2-1

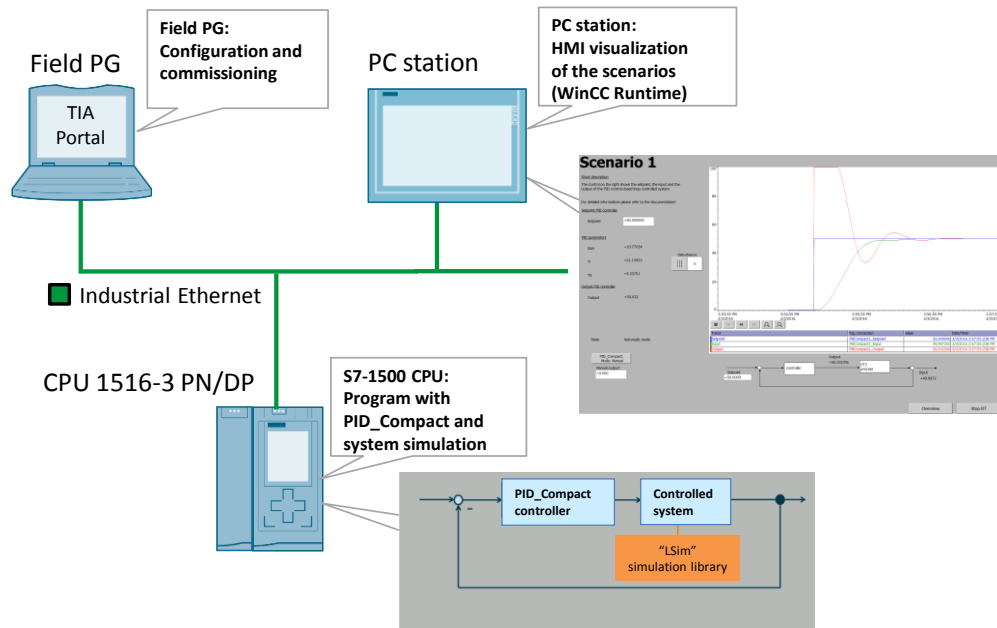

To demonstrate the application task, a closed-loop control system is implemented by the S7-1500 with the aid of the "PID\_Compact" block and the "LSim" simulation library.

The PC station is used for visualizing the control loops.

The field PG is used for commissioning the application.

#### Note

Field PG and PC station can be implemented by a PC (see chapter 6). Alternatively, the example can also be fully implemented with PLCSIM.

#### Advantages

This application provides the following advantages:

- Step-by-step description for first commissioning of a "PID\_Compact" controller.
- Quick way to get started handling the functions of "PID\_Compact".
- Saves time and costs by simulating controlled systems with the aid of the "LSim" controlled system library.

**Delimitation**

This application does not include a description of

- STEP 7 V14.
- WinCC Runtime Professional V14
- the SCL programming language.

Basic knowledge of these topics is required.

**2.2 Scenarios of the application****Structure of the application**

The STEP 7 project is divided into two scenarios that are used to explain various aspects of handling the "PID\_Compact" function and the "LSim" simulation library for controlled systems.

**Scenarios**

The following scenarios are implemented for illustration purposes:

Table 2-1

No.	Scenario	Content of the scenario
1	Closed-loop control of a PT3 system simulation with the aid of "PID_Compact".	<ul style="list-style-type: none"> <li>• Parameterizing the PT3 system simulation.</li> <li>• Parameterizing and configuring "PID_Compact".</li> <li>• Commissioning "PID_Compact" with pretuning and fine tuning.</li> </ul>
2	Closed-loop control of a more complex controlled system consisting of PT1, PDT1, lagging and PT2 element.	<ul style="list-style-type: none"> <li>• Interconnecting the individual system simulations.</li> <li>• Commissioning "PID_Compact" with pretuning and fine tuning.</li> </ul>

**Thematic content of the scenarios**

The following table provides an overview of the scenarios' tasks. The right column contains the reference to the step-by-step instructions of the task in the documentation.

Table 2-2

Task	Scenario		Description in chapter (link)
	1	2	
Parameterizing "PID_Compact"	X	X	Chapter <a href="#">5.1</a> and chapter <a href="#">5.2</a> .
Commissioning (pretuning and fine tuning)	X	X	Chapter <a href="#">5.3.1</a> .
Inserting a single simulation element	X		Chapter <a href="#">5.4</a> .
Interconnecting multiple controlled systems		X	Chapter <a href="#">5.5</a> .

## 2.3 Visualization user interface

### WinCC Runtime

In the PC station of the TIA project, a visualization user interface (WinCC Runtime) is provided that allows the user to use the examples.

WinCC Runtime allows the user to:

- Monitor the state of the project's scenarios
- Modify individual tags of the scenarios.

### Overview

The figure below shows the visualization user interface of WinCC Runtime. For a detailed description of WinCC Runtime, please refer to chapter [7.2](#).

Figure 2-2 WinCC Runtime Scenario1 overview

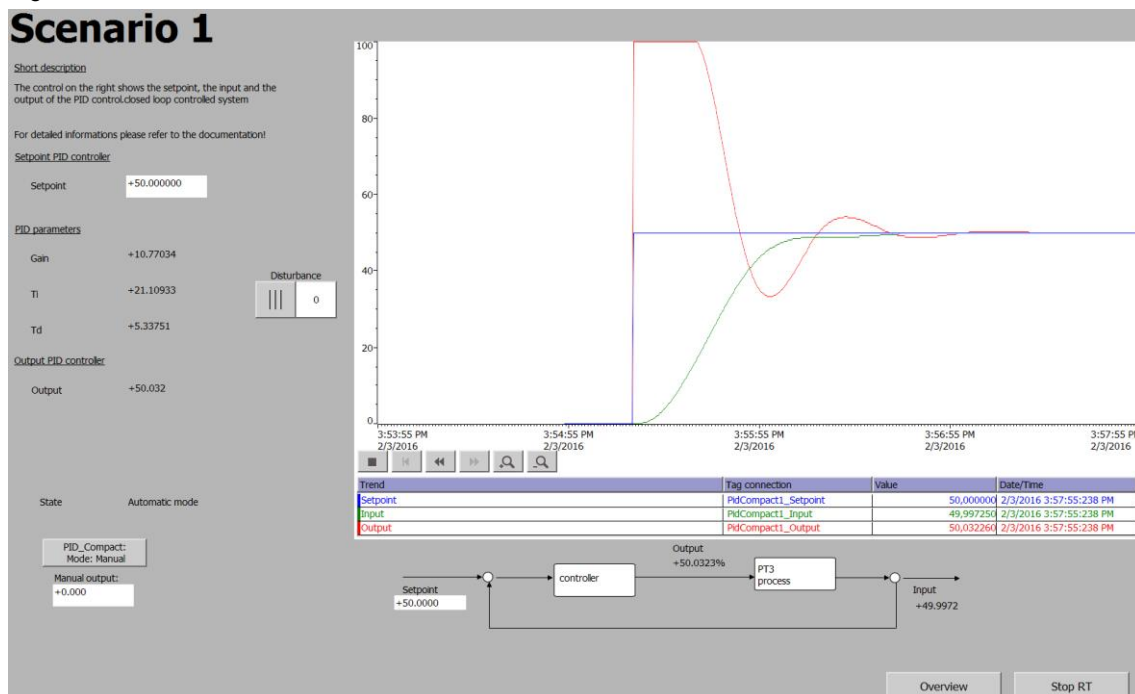

## 2.4 Hardware and software components

### 2.4.1 Validity

This application is valid for

- STEP 7 V14 Update 2 or higher
- S7-1500 firmware 2.0 or higher

### 2.4.2 Components used

This application was created with the following components:

## 2 Solution

### 2.4 Hardware and software components

#### Hardware components

Table 2-3

Component	No.	Article number	Note
PS 25W 24VDC	1	6ES7 505-0KA00-0AB0	Alternatively, other power supplies (24V DC) can also be used.
CPU 1516-3 PN/DP	1	6ES7 516-3AN01-0AB0	Alternatively, other CPUs from the S7-1500 range can also be used.
PC station	1	e.g., 6ES7647-6C...-....	Any PC station with appropriate software can be used.

#### Software components

Table 2-4

Component	No.	Article number	Note
STEP 7 V14 (TIA Portal V14)	1	6ES7822-1AE04-0YA5	Component for programming the S7-1500.
WinCC V14 Professional (TIA Portal V14)	1	6AV2103-0DA04-0AA5	Component for configuring the visualization.

#### Sample files and projects

The following list contains all files and projects that are used in this example.

Table 2-5

Component	Note
79047707_PidCompactV2_3_PRJ_V3_0_0.zip	This zip file contains the STEP 7 project.
79047707_LSim_LIB_V3_0_0.zip	"LSim" controlled system simulation library.
79047707_PidCompactV2_3_DOC_V3_0_0_en.pdf	This document.
79047707_LSim_DOC_V3_0_0_en.pdf	Description of the "LSim" controlled system simulation library.



## 3 Basics of Control Engineering

### Overview

Control engineering is a branch of engineering that researches how to specifically influence given variables in technical systems. The aim is to achieve and maintain the desired value of this variable under certain conditions.

This chapter provides a very brief outline of “control engineering”.

The “SIMATIC S7-1200, S7-1500 PID Control” Function Manual covers the basics of control engineering ([4](#)).

### Controlled system

A controlled system contains the variable to be controlled, such as the temperature of a room. To identify the type of a system and then dynamically control it in an optimal way, the system to be controlled must be analyzed in detail.

One option to identify the type is to look at the step response of a controlled system. As an example, the following figure shows the step response of a PTn system (for example, temperature in a room).

The time response can be approximately defined by the following variables:

- Delay time  $T_u$
- Compensation time  $T_g$
- Maximum value  $X_{max}$

Figure 3-1 PTn system step response

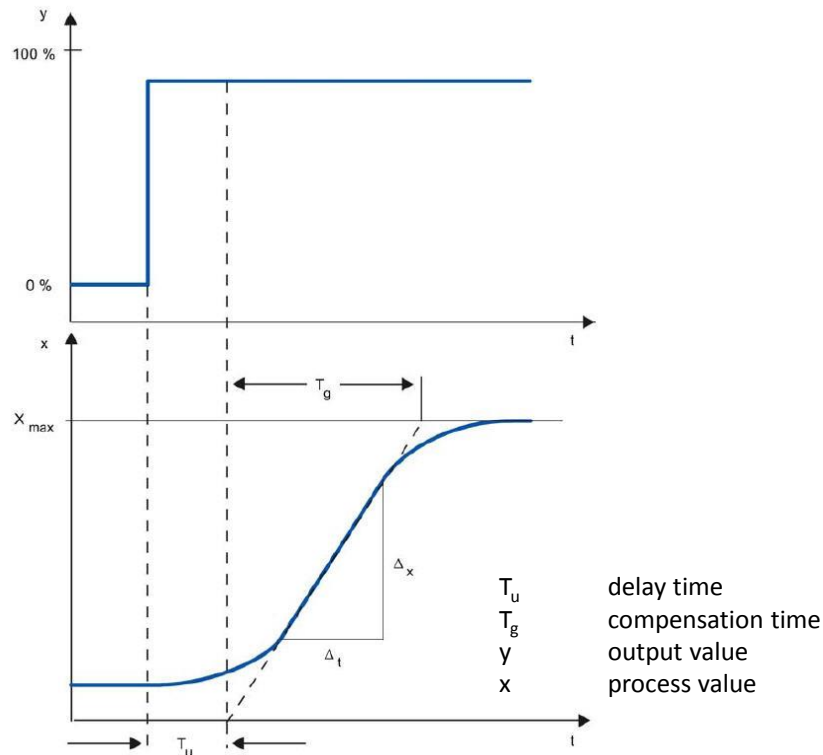

##### Controller

The controller controls an actuator to bring the controlled system to a desired state. The simplest controllers are two-position controllers that only know the states “ON” and “OFF” and use them to control the controlled system via the actuator.

The frequently used PID controllers consist of three parts:

- The P component generates an output signal proportional to the system deviation.
- The I component integrates the system deviation over time and, due to this integration, affects the controlled system.
- The D component, however, responds to the changed system deviation (time derivation of the system deviation).

These three components of the ideal PID controller are weighted by the coefficients proportional gain, integral action time and derivative action time.

With the “PID\_Compact”, “PID\_3Step” and “PID\_Temp” blocks, the SIMATIC S7-1500 offers a software control option that is already integrated in the firmware.

##### Note

This application uses “PID\_Compact”. For more information on “PID\_3Step” and “PID\_Temp”, please refer to manual [4](#), the TIA Portal Help and application examples [9](#) and [10](#).

##### Control loop

In a control loop, the system deviation between setpoint and process value is determined by the controller and a manipulated variable is derived from this deviation. The manipulated variable acts on the controlled system via an actuator (see [Figure 3-2](#)).

Figure 3-2 Simple control loop

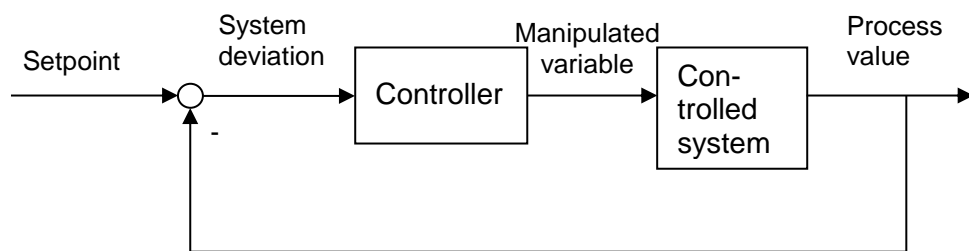

A simple example of a control loop is the control of the room temperature using a heater. The room temperature is measured with a sensor and fed to a controller. This controller compares the current room temperature to a setpoint and calculates an output value (manipulated variable) for controlling the heater.

## 4 Function mechanisms

### Structure

This chapter introduces the individual scenarios of the STEP 7 program and describes the individual blocks in greater detail.

It describes the exact behavior of the two scenarios and provides a figure of the entire control loop for each scenario.

### Project engineering

This chapter does not describe the configuration, commissioning and optimization of "PID\_Compact". For the appropriate step-by-step instructions, please refer to chapter [5](#).

## 4.1 Structure of the sample project

### Scenarios

The sample project consists of the scenarios listed in chapter [2.2](#) that are independent of each other.

### Program overview

The S7 program of the CPU 1516-3 PN/DP has the following structure:

Figure 4-1

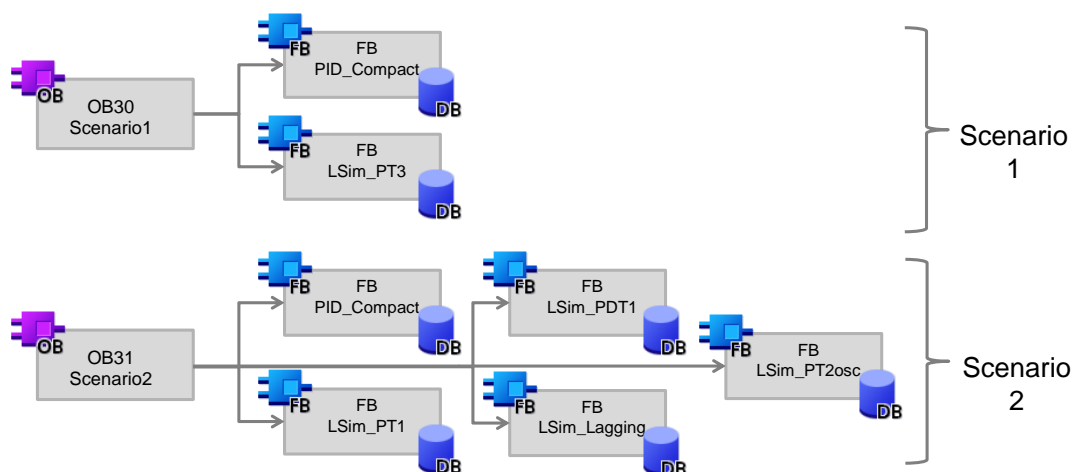

### Assignment

Except for the "PID\_Compact" FB (FB1130) used in all scenarios, the individual blocks can be clearly assigned to the existing scenarios.

**User blocks**

Table 4-1 Blocks and instructions of the simulation library

Element	Symbolic name	Description	
OB30	Scenario1	Cyclic interrupt OB: Implements the scenario described in chapter <a href="#">4.2</a> : Closed-loop control of a PT3 system with the aid of the "PID_Compact" controller	Scenario1
DB2	PidCompact1	Instance DB for the "PID_Compact" block	
DB100	Scenario1Tags	Block with parameters for supplying the block calls in Scenario 1	
FB54	LSim_PT3	Simulation of a PT3 element	
DB101	InstLSim_PT3	Instance DB of FB "LSim_PT3" (FB54)	
OB31	Scenario2	Cyclic interrupt OB: Implements the scenario described in chapter <a href="#">4.3</a> : Closed-loop control of a simulated controlled system consisting of PT1, PDT1, lag and PT2 element with the aid of the "PID_Compact" controller.	Scenario2
DB6	PidCompact2	Instance DB for the "PID_Compact" block.	
DB200	Scenario2Tags	Block with parameters for supplying the block calls in Scenario 2.	
FB50	LSim_PT1	Simulation of a PT1 element.	
DB201	InstLSim_PT1	Instance DB of FB "LSim_PT1" (FB50).	
FB52	LSim_PT2osc	Simulation of a periodic PT2 element.	
DB202	InstLSim_PT2osc	Instance DB of FB "LSim_PT2osc" (FB52).	
FB55	LSim_PDT1	Simulation of a PDT1 element.	
DB203	InstLSim_PDT1	Instance DB of FB "LSim_PDT1" (FB55).	
FB59	LSim_Lagging	Simulation of a lag element.	
DB204	InstLSim_Lagging	Instance DB of FB "LSim_Lagging" (FB59).	
FB1130	PID_Compact	System block: Digital PI/PID controller; called in each scenario. Always used as a PID controller – not as a PI controller – in this application.	

**Blocks of the "LSim" simulation library**

The project also uses blocks from the "LSim" simulation library that is provided on the same HTML page as this document.

The following blocks are from the library:

- LSim\_PT3
- LSim\_PT1
- LSim\_PDT1
- LSim\_Lagging
- LSim\_PT2osc

The "LSim" simulation library provides more simulation blocks for simulating controlled systems.

For a detailed description of the individual simulation blocks, please refer to the library description document ([Table 2-5](#)).

4.2 Scenario 1: Calling and commissioning “PID\_Compact”

**FB “PID\_Compact” (FB1130) software controller**

The “PID\_Compact” system block (FB1130) implements a PID software controller with the following interface:

Figure 4-2

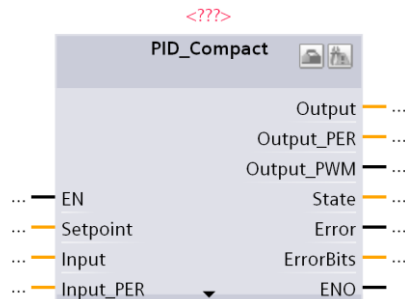

For a detailed description of FB “PID\_Compact” (FB1130) and its parameters, please refer to the TIA Portal Help.

## 4.2 Scenario 1: Calling and commissioning “PID\_Compact”

### 4.2.1 Task: Control a simulated PT3 system

**Task**

Show how to simulate a PT3 controlled system with the simulation library. Control the PT3 controlled system with the “PID\_Compact” block.

**Schematic diagram**

Figure 4-3

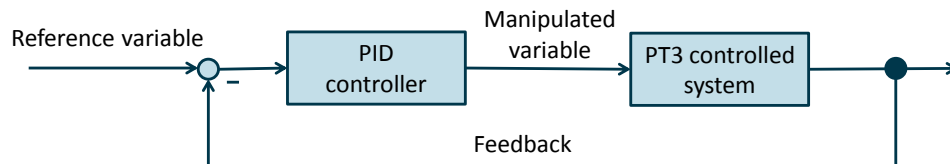

**Step response**

The figure below shows the step response of the PT3 controlled system when the input jumps from 0→50:

Figure 4-4

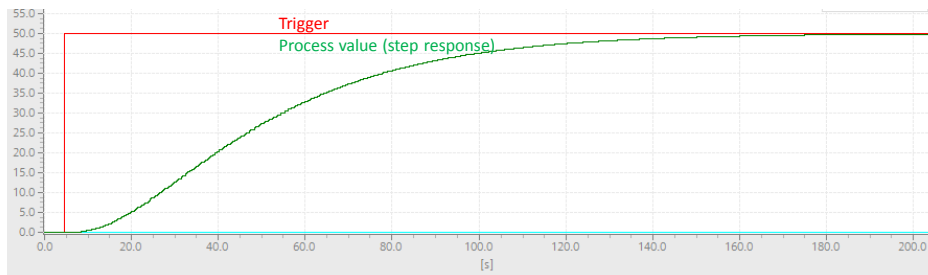

### 4.2.2 Procedure

#### Overview

The following tasks have to be performed to implement the user program:

- Insert the PT3 system simulation into the user program and parameterize it.
- Add the "PID\_Compact" block to the user program.
- Configure the "PID\_Compact" block.
- Commission the software controller with pretuning and fine tuning.

#### Step-by-step description

For the associated step-by-step description for the individual actions, please refer to chapter [5](#).

#### Note

If you do not want to reprogram the individual actions with the aid of chapter [5](#), you can also access the sample project directly. The sample project contains Scenario1 that has already been commissioned.

### 4.2.3 Controlled system: Scenario1

#### Overview

After commissioning the sample project as described in chapter [6](#), you can directly monitor the behavior of the controlled system.

#### Parameters and formula for "PID\_Compact"

After fine tuning, the following parameters are active in the "PID\_Compact" software controller:

Table 4-2 Symbols and parameters

Symbol	Description	Value
$K_p$	Proportional gain	10.770338
$T_I$	Integral action time	21.10933
$T_D$	Derivative action time	5.337515
$a$	Derivative delay coefficient	0.1
$b$	Proportional action weighting	0.2586402
$c$	Derivative action weighting	0.0
$y$	Output value of the PID algorithm	-
$s$	Laplace operator	-
$w$	Setpoint	-
$x$	Process value	-

The PID algorithm of "PID\_Compact" (FB1130) is based on the following formula:

## 4 Function mechanisms

### 4.2 Scenario 1: Calling and commissioning "PID\_Compact"

$$y = K_p \left[ (b * w - x) + \frac{1}{T_i * s} (w - x) + \frac{T_D * s}{a * T_D * s + 1} (c * w - x) \right]$$

#### Monitoring the controlled system

Chapter 7 describes how to monitor and control the controlled system with the aid of the provided visualization using WinCC Runtime Advanced.

#### Control response of the system

After commissioning Scenario1, a setpoint step-change from 0→50% results in the following response:

Figure 4-5

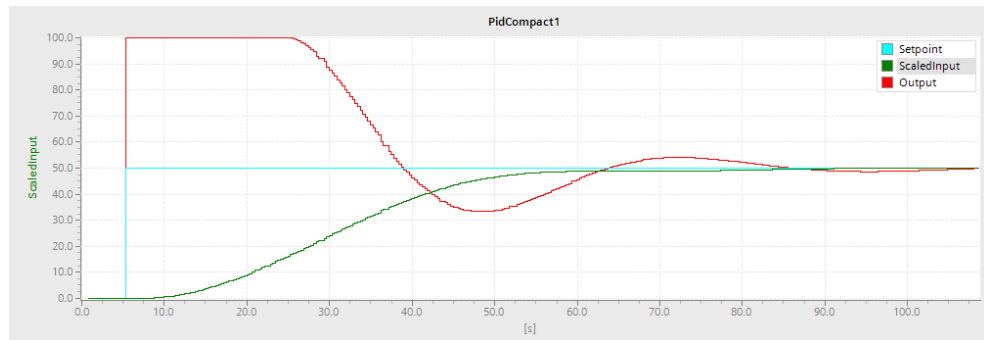

### 4.3 Scenario 2: Simulation and closed-loop control of a more complex controlled system

#### 4.3.1 Task: Control a simulated more complex controlled system

##### Task

Simulate a more complex controlled system with the aid of the “LSim” controlled system simulation library and control it using the “PID\_Compact” block. Use the “pretuning” and “fine tuning” functions for commissioning.

The controlled system should consist of the following elements:

Table 4-3

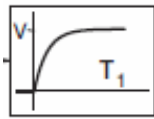
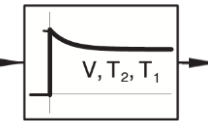
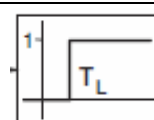
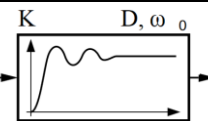
Type	Schematic step response	Example: real process
PT1 element		Controlled system speed, inverter
PDT1 element		Use in step change-capable systems
Lag element (lagging)		Conveyor system, gear
PT2 element (periodic)		Oscillating mechanical system, strokes/rotations

**Note** Simulating a real controlled system can save time and costs when commissioning a controller!

##### Schematic diagram

The more complex controlled system consists of the following elements:



Figure 4-6

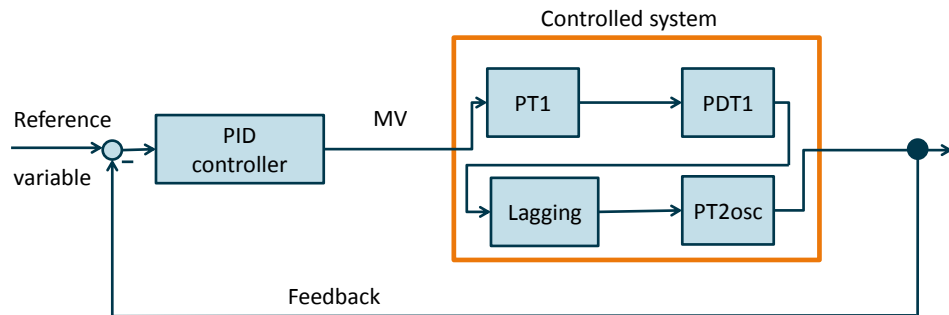

**Step response**

The step response of the combined controlled system is shown below:

Figure 4-7

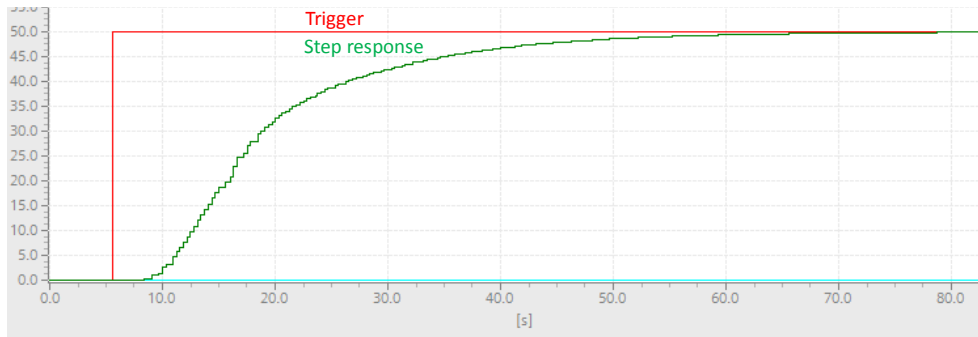

The following parameters are used for the individual elements:

Table 4-4

	tmLag1	tmLag2	gain	delayCycles
PT1	12.0	-	1.0	-
PDT1	3.0	5.0	1.0	-
Lag	-	-	-	5 (= 1.5 s)
Periodic PT2	0.4 (omega)	0.65 (damp)	1.0	-

**4.3.2 Procedure**

**Overview**

The procedure for this scenario corresponds to the one in Scenario 1:

- Insert the individual elements of the controlled system into the program and parameterize them.
- Add, parameterize and commission the "PID\_Compact" software controller.

**Note**

If you do not want to reprogram the individual actions with the aid of chapter 5, you can also access the sample project directly. The sample project contains "PID\_Compact" that has already been commissioned.

**Step-by-step description**

For the step-by-step description, please refer to chapter 5.

**Monitoring the controlled system**

Chapter 7 describes how to monitor and control the controlled system with the aid of the provided visualization using WinCC Runtime Advanced.

**“PID\_Compact” parameters**

The following fine-tuned parameters result for the “PID\_Compact” block:

Table 4-5 Complex controlled system parameter set

	PID_Compact
$K_p$	0.9506688
$T_i$ [s]	8.276175
$T_D$ [s]	2.224364
<b>a</b>	0.1
<b>b</b>	0.532196
<b>c</b>	0.0

**Control response of the system**

A setpoint step-change from 0 to 50 in the steady-state control loop results in the following response at the inputs and outputs of the “PID\_Compact” controller.

Figure 4-8

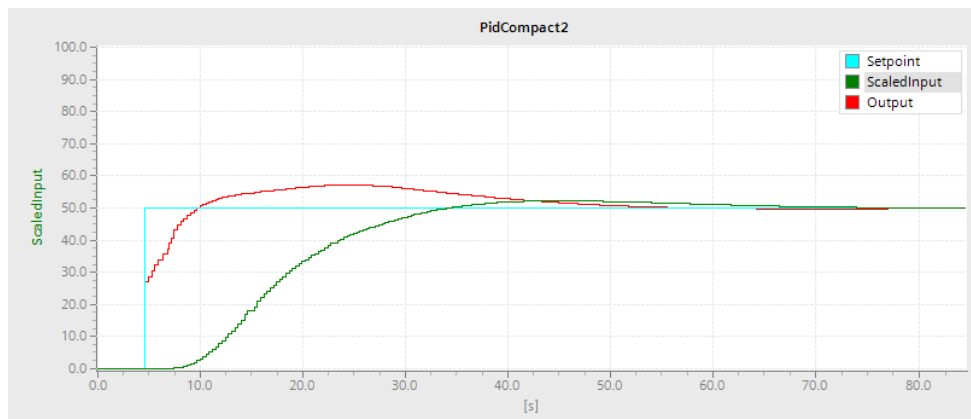

## 5 Configuration and Programming

### Contents

This chapter discusses the configuration and project engineering implemented on the S7-1500 CPU side in the sample project ([Table 2-5](#)).

Step-by-step instructions show you how to set up and optimize a simulated control loop.

### Outline

The following chapters are available for handling FB "PID\_Compact" (FB1130):

- Inserting FB "PID\_Compact" (FB1130).
- Parameterizing FB "PID\_Compact" (FB1130).
- Commissioning FB "PID\_Compact" (FB1130).

The following chapters describe how to handle the "LSim" simulation library:

- Inserting a function block of the simulation library.
- Simulation of a controlled system with multiple elements.

The following table shows the chapters relevant for the different scenarios:

Table 5-1 Necessary configuration steps in the scenarios

Task	Scenario		Description in chapter (link)
	1	2	
Parameterizing "PID_Compact"	X	X	Chapter <a href="#">5.1</a> and chapter <a href="#">5.2</a> .
Commissioning (pretuning and fine tuning)	X	X	Chapter <a href="#">5.3.1</a> .
Inserting a single simulation element	X		Chapter <a href="#">5.4</a> .
Interconnecting multiple controlled systems		X	Chapter <a href="#">5.5</a> .

## 5.1 Inserting FB "PID\_Compact" (FB1130)

### Variants

There are several options for inserting FB "PID\_Compact" into a project as a technology object.

Please note that calling "PID\_Compact" as a multi-instance does not generate a technology object. You can continue to use the FB – however, without graphics support of the technology object.

### Procedure

The following table shows one option of adding the "PID\_Compact" technology object to a project.

Table 5-2

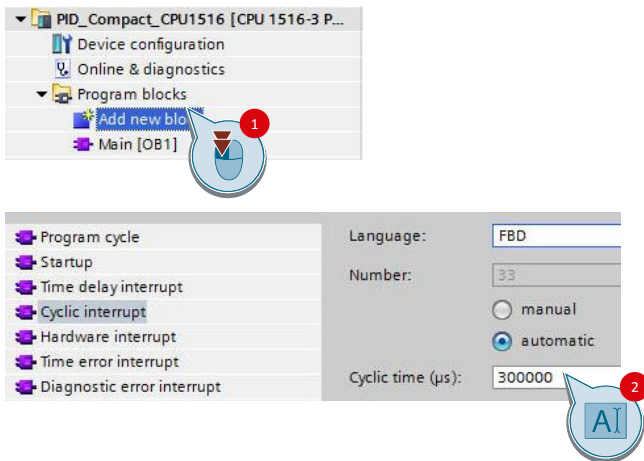
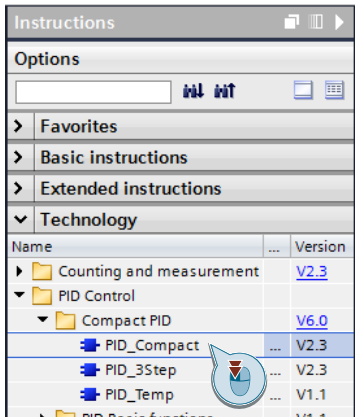
No.	Action
1.	<p>Insert a cyclic interrupt OB (1), for example, with a cycle time of 300 ms (2). The cycle time used is the sampling time of your controller. To ensure a constant sampling time of the controller, a PID controller must always be called in a cyclic interrupt OB.</p> 
2.	<p>In the instructions, double-click to add an instance of "PID_Compact" to any network of the cyclic interrupt OB created in step 1.</p> 

## 5 Configuration and Programming

### 5.1 Inserting FB "PID\_Compact" (FB1130)

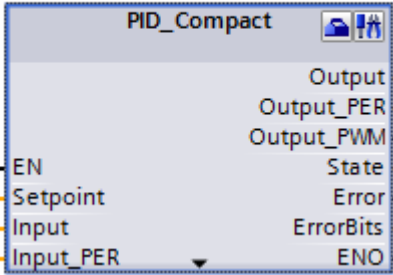
No.	Action
3.	<p>Select a name for the instance data block/technology object.</p> <div data-bbox="319 336 845 672" style="border: 1px solid black; padding: 5px; margin: 10px 0;"> <p style="text-align: center; color: cyan;">%DB2</p> <p style="text-align: center;">*PidScenario1*</p> <div style="border: 1px solid blue; padding: 5px; margin: 5px 0;"> <p style="text-align: center; margin: 0;">PID_Compact</p>  </div> </div> <p><b>Note!</b> When you call the "PID_Compact" function as a multi-instance, no technology object will be generated.</p> <p>Explanation: A technology object is the convenient, graphics-supported representation of a data block. The 'classic' display of the data block is possible by clicking "Open DB Editor" in the context menu of the technology object.</p>
4.	The FB has now been integrated into the user program.

## 5.2 Parameterizing FB "PID\_Compact" (FB1130)

### Parameters

The technology object of FB "PID\_Compact" already contains many settable parameters.

For a detailed description of all parameters, please refer to the TIA Portal V14 Help.

### Procedure

Table 5-3

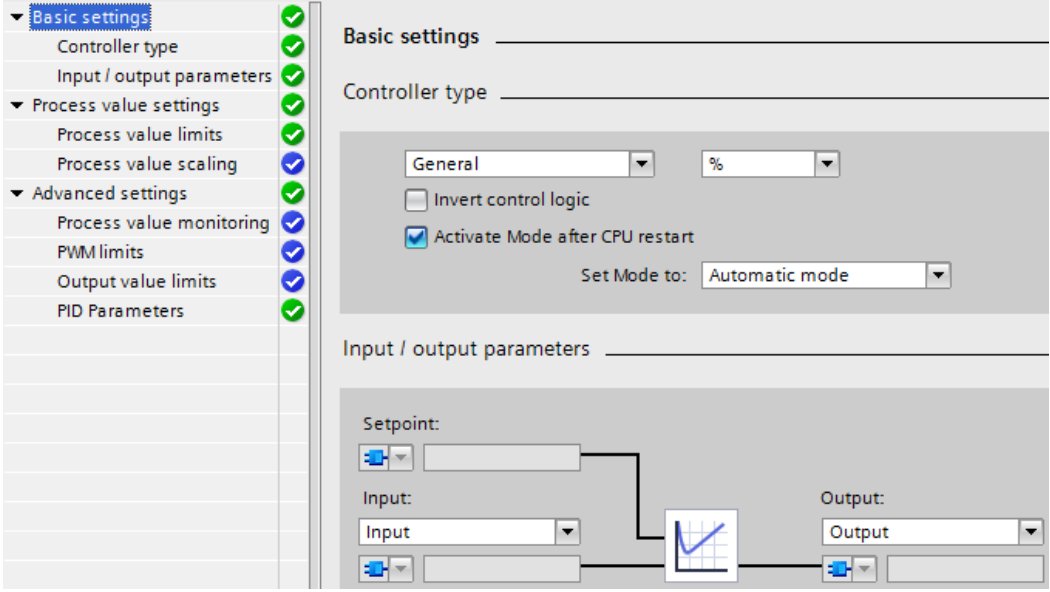
No.	Action
1.	In the project tree, open the object: "Technology objects > [Your_PID_instance] > Configuration".
2.	<p>In the "Basic Settings" window, select the unit for setpoint and process value for display in the parameter view (for example, temperature in °C).</p> <p>Furthermore, you can invert the control direction at this point. This is necessary, for example, for cooling as in this case a higher actuating signal (cooling power) reduces the process value (temperature).</p> <p>In addition, this is where you define the start behavior of the controller when restarting the CPU. You can choose between inactive, pretuning, fine tuning, manual or automatic mode.</p> <p>In the "Input" drop-down list, you define whether you want to use a floating-point number or the integer value of an analog input as the process value.</p> <p>In addition to this, the "Output" drop-down list provides the option to use a PWM output as the manipulated variable.</p> 
3.	The input parameters are interconnected directly at the block in the user program and cannot be interconnected in the configuration view of the technology object.

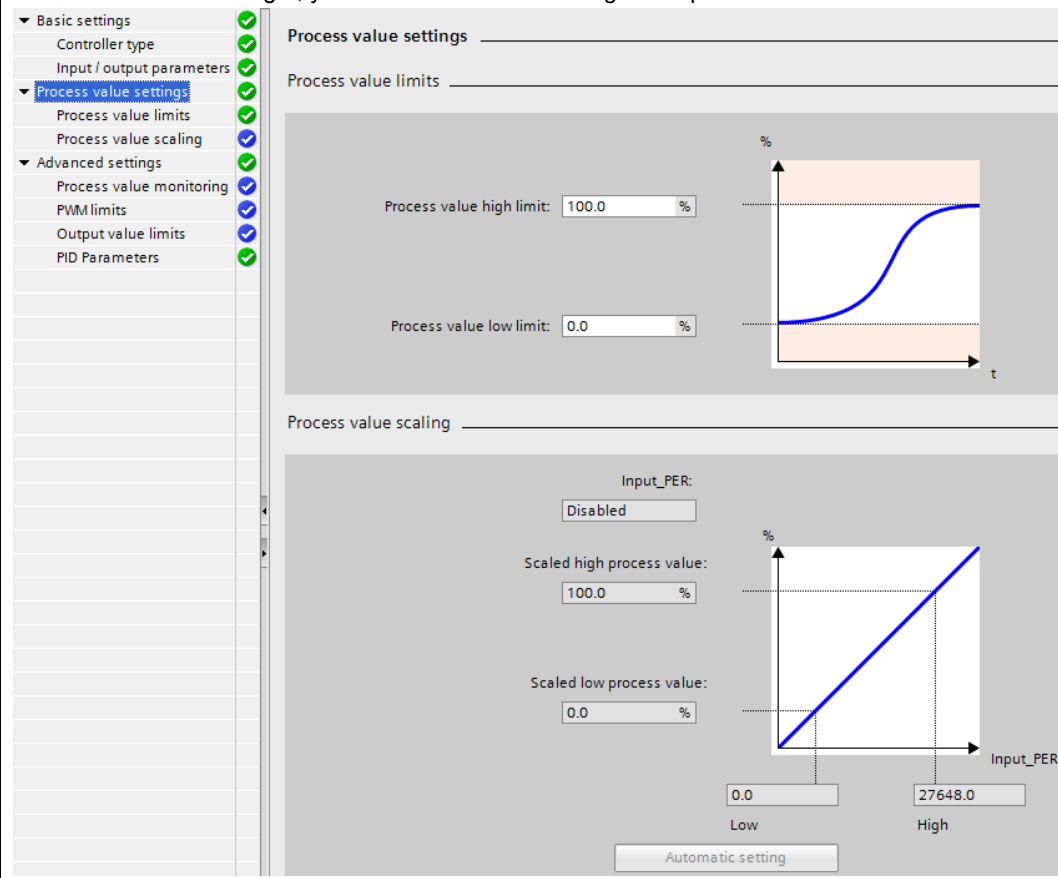
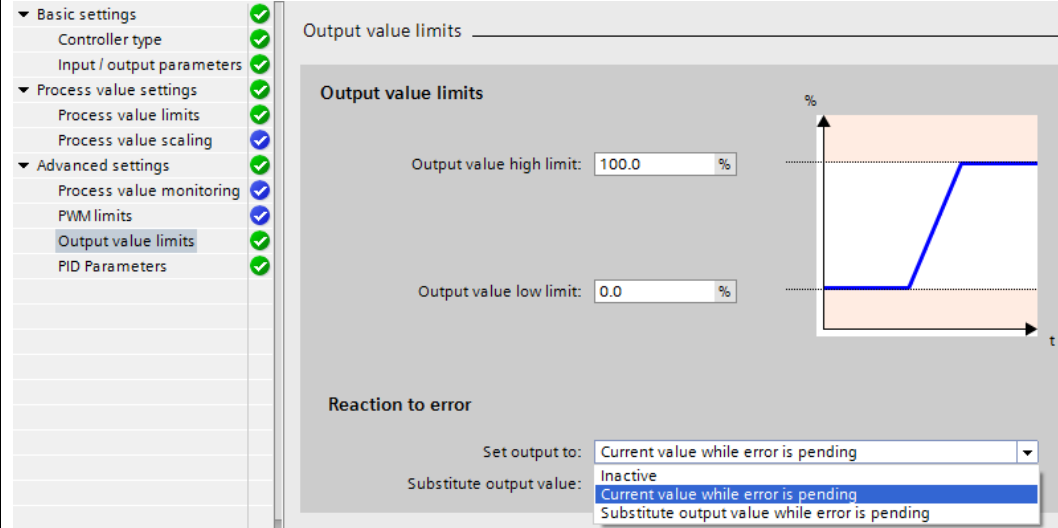
No.	Action
4.	<p>In "Process value settings", you set the limits and scaling of the process value.</p> 
5.	<p>Among other things, "Advanced settings" allows you to read out the current PID parameters and change them if necessary. However, you do not need to manually enter these parameters as they are adjusted during optimization.</p> <p>In "Output value limits", you will find the "Reaction to error" settings. You can select whether the controller should be inactive or output a substitute value or the last valid value while the error is pending (for example, if the process value limits are violated).</p> 

5.3 Commissioning FB "PID\_Compact" (FB1130)

No.	Action
6.	Save your changes or use "Online > Download and reset PLC program" to download the user program to the CPU.

For a detailed list of the individual parameters, including a description, please refer to the "SIMATIC S7-1200, S7-1500 PID Control" Function Manual (4), chapter "Configuring PID\_Compact V2". For more help, press "F1" when the focus is on the "PID\_Compact" block.

### 5.3 Commissioning FB "PID\_Compact" (FB1130)

When you have made your desired configuration settings on the controller, you can commission the controller.

You can:

- Use the existing commissioning tool and have STEP 7 calculate the controller parameters via pretuning and fine tuning (chapter 5.3.1).
- Transfer your own calculated controller parameters to the controller (chapter 5.3.2).

#### 5.3.1 Commissioning with pretuning and fine tuning

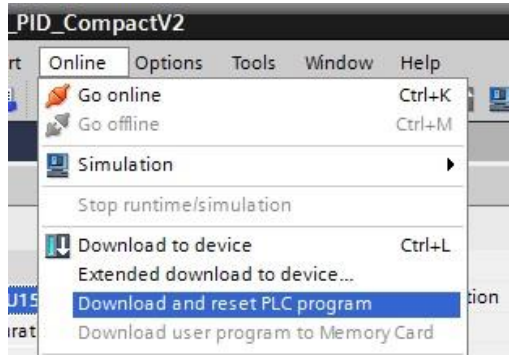
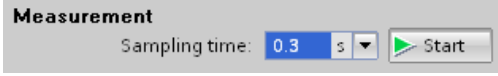
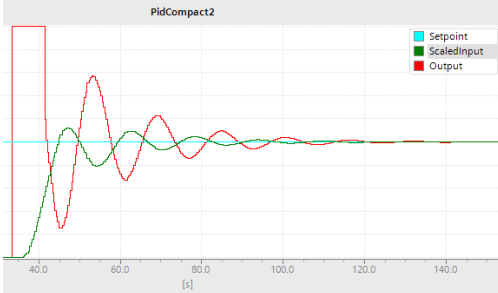

Table 5-4 Pretuning and fine tuning

No.	Action	Comment
1.	Make sure that the correct controller structure (PI or PID parameters) has been set.  The individual scenarios use only the PID controller structure.	In the project tree, navigate to "[Your_CPU] > Technology objects > [Your_PID_Compact] > Configuration > PID Parameters > Controller structure".  To find the suitable controller for a controlled system, please refer to the technical literature, for example 4, chapter 2.7.
2.	Use, for example, a MOVE command to interconnect <ul style="list-style-type: none"> <li>• the output of the PID controller with the input of the controlled system.</li> <li>• the output of the controlled system with the input of the PID controller.</li> </ul>	
3.	Use "Online > Download and reset PLC program" to download the PLC program to your CPU.	



## 5 Configuration and Programming

### 5.3 Commissioning FB "PID\_Compact" (FB1130)

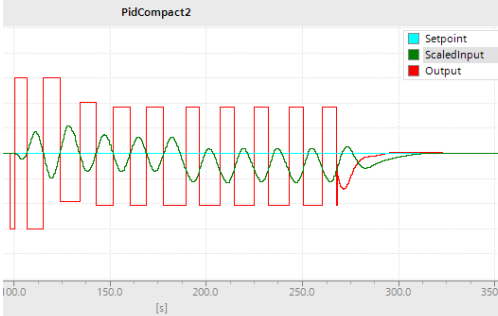
No.	Action	Comment
4.	<p>In the "PidCompact1" technology object, double-click "Commissioning".</p> <p>In "Measurement", click "Start" to go online.</p>	 <p>Now you can see the values for Setpoint, Input and Output in a graphic representation.</p>
5.	<p>Clicking Start in "Pretuning" starts pretuning under the following conditions:</p> <ul style="list-style-type: none"> <li>• "PID_Compact" is called in a cyclic interrupt OB.</li> <li>• ManualEnable = FALSE.</li> <li>• Reset = FALSE.</li> <li>• "PID_Compact" is in "Manual", "Inactive" or "Automatic" mode.</li> <li>• Setpoint and process value are within the configured limits.</li> <li>• The difference between setpoint and process value is greater than 30% of the difference between process value upper limit and process value lower limit.</li> <li>• The difference between setpoint and process value is &gt;50% of the setpoint</li> </ul> <p><b>Note</b> You can control the setpoint, for example, using the watch table.</p>	<p>Possible pretuning trend:</p> 
6.	<p>If pretuning does not start, the tooltip displays an error code or error message. The TIA Portal Online Help provides help in interpreting the messages.</p>	<p>Tuning status</p> <p>Progress: <input type="text"/></p> <p>Status: <span style="background-color: yellow;">Error when starting pretuning. The process value during pretuning: the process value is too</span> </p> <p><span style="background-color: yellow;">Shows the status of tuning.</span></p> <p><input type="button" value="ErrorAck"/></p>
7.	<p>After successful pretuning, fine tuning can be additionally performed.</p> <p>Fine tuning can also be started without previous pretuning.</p> <p>The fine tuning parameters mostly show a better command and disturbance behavior than the pretuning parameters.</p> <p>Precondition for fine tuning:</p> <ul style="list-style-type: none"> <li>• "PID_Compact" is called in a cyclic interrupt OB.</li> <li>• "ManualEnable" = FALSE.</li> <li>• "Reset" = FALSE.</li> <li>• Setpoint and process value are within the configured limits.</li> <li>• The control loop is in the steady state at the operating point.</li> <li>• No failures are expected.</li> <li>• "PID_Compact" is in "Inactive", "Automatic" or "Manual" mode.</li> </ul>	<p>Possible fine tuning trend:</p> 

**5.3.2 Commissioning with specified PID parameters**

If you do not want to use the optimization functions but your own parameters for the PID controller, follow the instructions in the table below.

Table 5-5

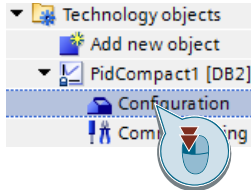
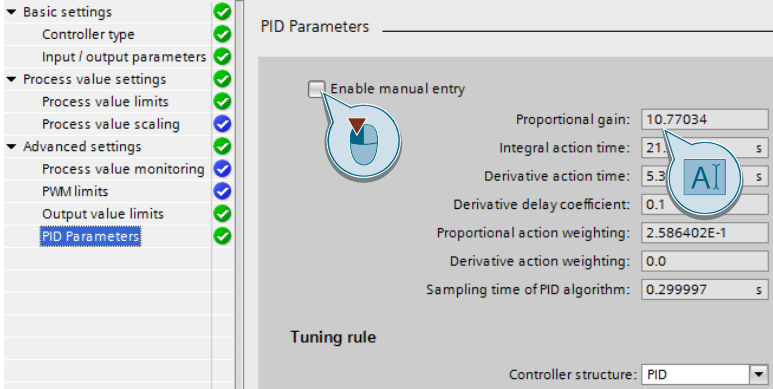
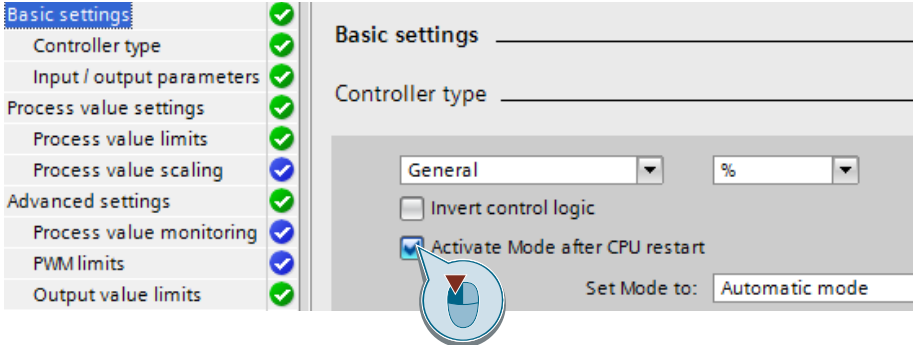
No.	Action
1.	<p>Choose the technology object In the project view and open the configuration window of the controller you want to set.</p> 
2.	<p>Navigate to "PID Parameters" and check the "Enable manual entry" check box. Now you can enter your parameters for the PID controller.</p> 
3.	<p>Then go to the "Basic settings", check the "Activate Mode after CPU restart" check box and select the "Automatic mode" item in the drop-down list.</p>  <p><b>Note!</b> When you have interconnected the "Mode" and "ModeActivate" inputs, make sure that Mode = 3 (corresponds to automatic mode).</p>

## 5 Configuration and Programming

### 5.3 Commissioning FB "PID\_Compact" (FB1130)

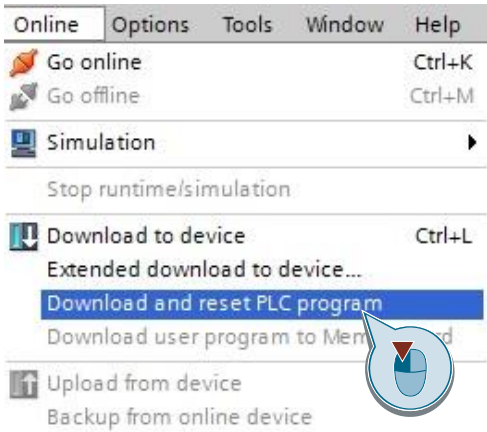
No.	Action
4.	<p>Now use "Online &gt; Download and reset PLC program" to download the user program to the CPU.</p> <p>Your manually entered parameters have been applied and "PID_Compact" controls the system with these parameters.</p>  <p>The screenshot shows the 'Online' menu with the following items:</p> <ul style="list-style-type: none"><li>Go online (Ctrl+K)</li><li>Go offline (Ctrl+M)</li><li>Simulation</li><li>Stop runtime/simulation</li><li>Download to device (Ctrl+L)</li><li>Extended download to device...</li><li><b>Download and reset PLC program</b> (highlighted)</li><li>Download user program to Memory Card</li><li>Upload from device</li><li>Backup from online device</li></ul>

## 5.4 Inserting a function block of the simulation library

### Documentation

The download page of this entry ([12](#)) additionally provides a description of the STEP 7 V14 library ([Table 2-5](#)) supplied with the project.

### Procedure

The following table shows how to insert the simulation block FB, "Sim\_PT3" (FB54), into a user program and configure it. The other simulation elements are integrated in the same way.

Table 5-6 Inserting the system simulation

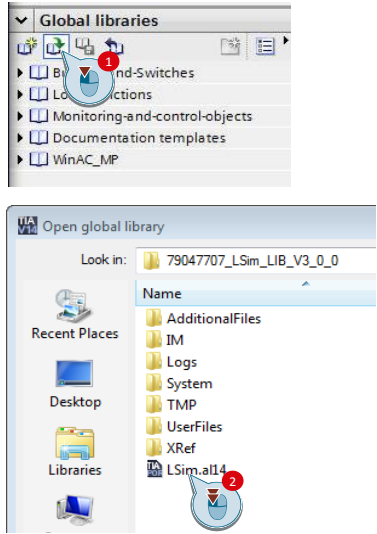
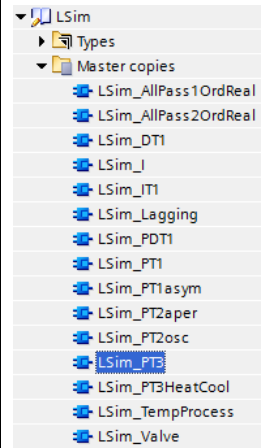
No.	Action	Comment
1.	Download the library file ( <a href="#">Table 2-5</a> ) and extract the file on your engineering station.	
2.	In the right-hand pane, open the "Libraries" tab and click "Open global library".  Navigate to the storage location of the extracted folder and double-click to open the "LSim" file.	
3.	Create a cyclic interrupt OB with a cycle time of, for example, 300 ms.	
4.	Drag the "LSim_PT3" block from the "Master copies" of the library to the cyclic OB. Create an instance data block for the function block. It is necessary that the simulation blocks are called in a cyclic interrupt OB.	

No.	Action	Comment
5.	<p>Call the block in the cyclic OB that has already been created and interconnect the parameters, for example, as follows:</p> <ul style="list-style-type: none"> <li>gain = 1.0</li> <li>tmLag1 = 29.0</li> <li>tmLag2 = 17.5</li> <li>tmLag3 = 3.1</li> <li>cycle = 0.3</li> </ul> <p>Also interconnect the "Reset" input with a controllable Boolean variable.</p>	<p><b>Note</b> The "cycle" parameter must correspond to the cycle time of the calling cyclic interrupt OB.</p>

## 5.5 Simulation of a controlled system with multiple elements

### Interconnecting controlled systems

Serial or parallel interconnection of controlled systems allows mapping even more complex real processes with the aid of the controlled system simulation library.

The steps for inserting a controlling element are the same as for inserting a PT3 system described in [Table 5-6](#).

### Serial interconnection

As an example, this section describes the implementation of a controlled system that consists of four serial simulation elements.

Figure 5-1

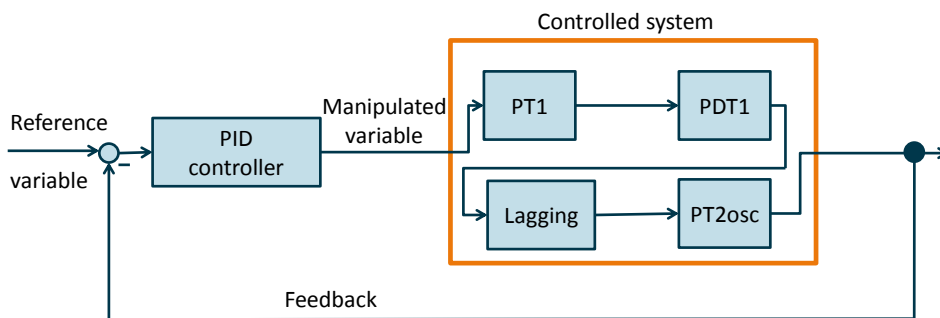

The following table describes the actions for inserting a controlled system that consists of multiple serial elements. Specifically, this is the example from Scenario2.

## 5 Configuration and Programming

### 5.5 Simulation of a controlled system with multiple elements

Table 5-7

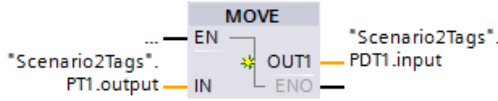
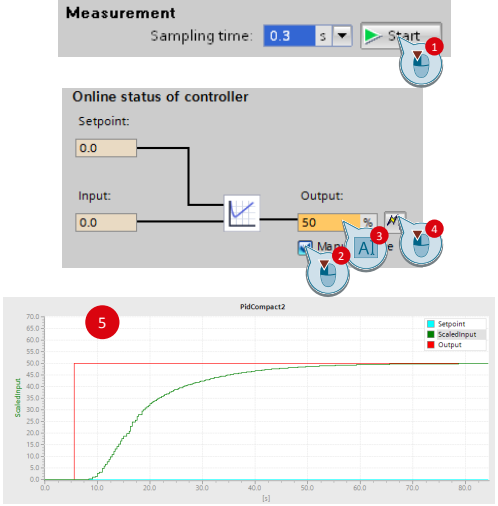
No.	Action	Comment
1.	<p>Add the controlling elements you want to use as described in <a href="#">Table 5-6</a>. In Scenario2, these are the following controlling elements:</p> <ul style="list-style-type: none"> <li>• PT1 (FB "LSim_PT1")</li> <li>• PDT1 (FB "LSim_PDT1")</li> <li>• Lag element (FB "LSim_Lagging")</li> <li>• PT2 in the periodic case. (FB "LSim_PT2osc")</li> </ul>	
2.	<p>Use MOVE commands to interconnect the outputs of the controlling elements with the input of the respective following controlling element.</p>	
3.	<p>As described in <a href="#">Table 5-2</a>, add "PID_Compact" to your project and interconnect (also using a MOVE command) the output of the controller with the input of the first controlling element. Interconnect the input of the controller with the output of the last controlling element.</p>	
4.	<p>Now you have set up a complete control loop. To download the controlled systems to the CPU, compile your program and download it to the CPU.</p> <p><b>Note</b> If you want to view the step response of the controlled system without closed-loop control (5), click "Start" (1) in the commissioning window "[Your_CPU] &gt; Technology objects &gt; [Your_PID] &gt; Commissioning". Then set the PID controller to Manual mode (2) and set a step change for the controlled system (set the output to a fixed value (3+4)).</p>	

**Parallel interconnection**

As an example, this section describes the implementation of a controlled system that consists of two parallel simulation elements.

Figure 5-2

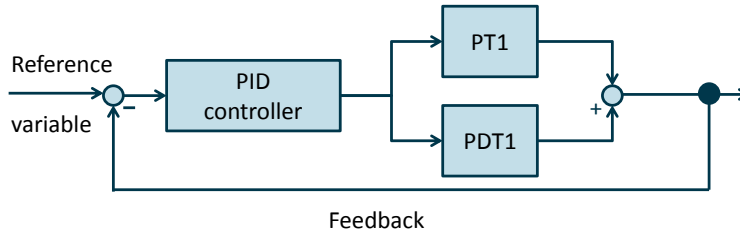

Both controlling elements receive the same input signal from the PID controller. Their output signals are added and returned to the controller.

Table 5-8

No.	Action
1.	Add the controlling elements you want to use as described in <a href="#">Table 5-6</a> . In this example, these are the following ones: <ul style="list-style-type: none"> <li>• PT1 (FB "LSim_PT1")</li> <li>• PDT1 (FB "LSim_PDT1")</li> </ul>
2.	Use two Move commands to interconnect the output of the PID controller with the input <ul style="list-style-type: none"> <li>• of the PT1 element.</li> <li>• of the PDT1 element.</li> </ul>
3.	Add the output values of the two controlled systems.
4.	Assign the added and, if necessary, scaled output signal as an input to the PID controller.

## 6 Installation and Startup

This chapter describes how to commission the supplied TIA Portal project.

You can either use the hardware described in chapter [2.4.2](#) (for commissioning, see chapter [6.1](#)) or completely simulate the project with PLCSIM (for commissioning, see chapter [6.2](#)).

### 6.1 Startup with the entire hardware

#### 6.1.1 Installing the hardware

The figure below shows a possible hardware configuration of the application. A configuration without the intermediate switch is also possible.

Figure 6-1

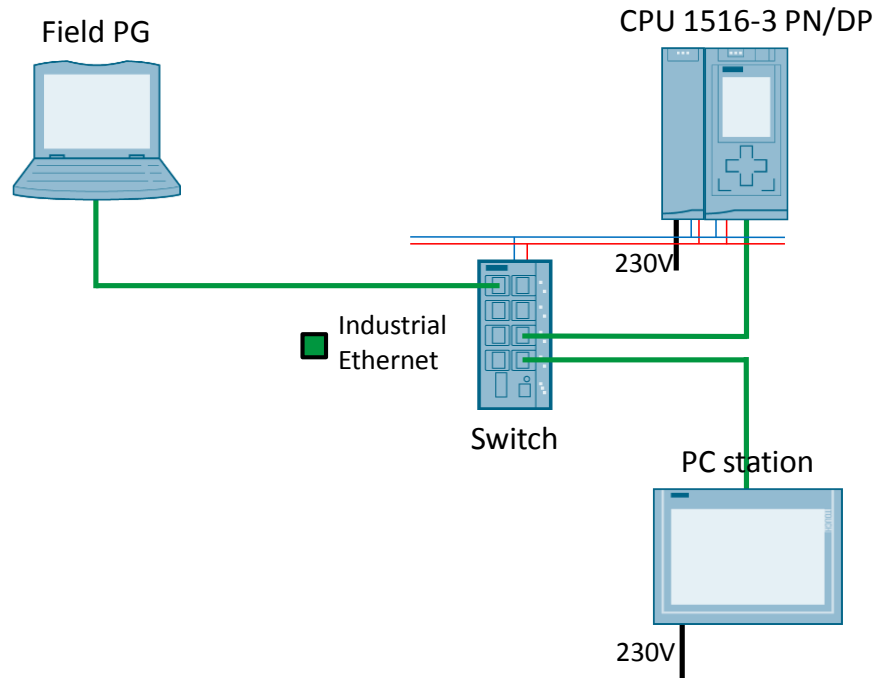

**Note** Always follow the installation guidelines for SIMATIC S7 systems (see also [16](#) and [17](#)).



## 6 Installation and Startup

### 6.1 Startup with the entire hardware

Table 6-1

No.	Action	Comment
1.	Attach the switch, the S7-1500 CPU and the power supply to a DIN rail.	
2.	Connect the S7-1500 CPU and the switch to the power supply.	
3.	Use an Ethernet cable to connect your engineering PC and the S7-1500 CPU to the switch via the X1 interface.	
4.	Supply the power supply with 230V AC.	
5.	Set the IP address of the X1 port of the S7-1500 in the display to the IP address used in the example (192.168.0.1). The IP address can be set in the display in "Settings > Addresses > X1 (IE/PN)".	<b>Note</b> For downloading to the CPU, the engineering station should be in the same subnet.

#### Note

The use of a field PG as an engineering station and at the same time as a PC station is described here.

Alternatively, for example, a rack PC can be used for visualization.

#### 6.1.2 Installing the software

This chapter describes the steps for installing the programs used.

Table 6-2 Installing the software components

No.	Action	Comment
1.	Install STEP 7 Professional V14.0.	Follow the information provided in the system manual: <a href="#">\3\</a>
2.	Install WinCC Professional V14.0.	Follow the information provided in the system manual: <a href="#">\8\</a>
3.	Download the sample project ( <a href="#">Table 2-5</a> ) from the Siemens Online Support page ( <a href="#">\2\</a> ).	

## 6 Installation and Startup

### 6.1 Startup with the entire hardware

#### 6.1.3 Configuring the hardware

##### Renaming the engineering station

The following table shows the procedure for changing the PC name in Windows 7:

Table 6-3 Renaming the engineering station

No.	Action	Comment
1.	To download WinCC Runtime to your engineering station, the engineering station must have the PC name used in the project ("VisuPC").	Alternatively, you can also adapt the name to your engineering station in the project.
2.	Click "Start". Go to the "Computer" context menu and click "Properties". In the following window, below "Computer name, domain and workgroup settings", click "Change settings".	
3.	In the "System properties" window, select "Change" and then enter the new computer name, "VisuPC", in the appropriate field.	More information</a>'. Below this, there are two input fields: 'Computer name:' with 'VisuPC' entered, and 'Full computer name:' with 'VisuPC' entered." data-bbox="525 328 858 463"/>
4.	Confirm and restart your engineering station to apply the computer name.	

##### Setting the IP address of the engineering station

When using the engineering station simultaneously as a PC station for visualization, you have to assign the IP address specified in the project to the engineering station:

Table 6-4 Assigning the IP address

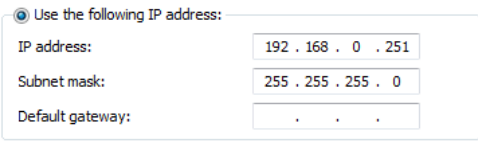

No.	Action	Comment
1.	Open "Start > Control Panel > Network and Sharing Center".	
2.	Click "Change Adapter Settings" and then select "Properties" in the context menu of your Ethernet adapter.	
3.	Select "Internet Protocol Version 4" and change the IP address as follows: IP address: 192.168.0.251 Subnet mask: 255.255.255.0	
4.	Click OK to confirm the change. Now your engineering station has the IP address assigned in the project ( <a href="#">Table 2-5</a> ).	
5.	In addition, set your PG/PC interface ("Start > Control Panel > Set PG/PC Interface") to TCP/IP and the network adapter you are using.	

## 6 Installation and Startup

### 6.1 Startup with the entire hardware

#### 6.1.4 Opening and downloading the TIA Portal project

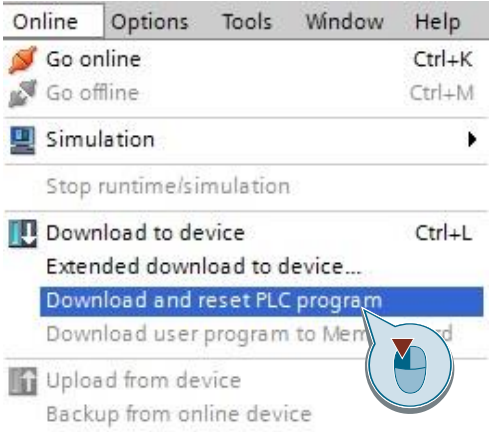
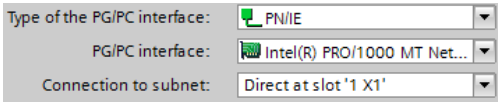
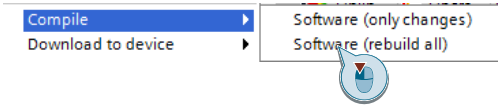
Table 6-5

No.	Action	Comment
1.	Download the zip project ( <a href="#">Table 2-5</a> ) to your engineering station and unzip the folder.	
2.	In the program folder, double-click the icon with the ".ap14" extension. The project now opens in TIA Portal V14.	
3.	Go to the project view. Click the "PID_Compact_CPU1516" CPU and use "Online > Download and reset PLC program" to download the user program to the CPU.	
4.	When downloading the program for the first time, you have to specify your interface and the subnet for downloading. Then select the CPU to be downloaded.	
5.	Compile the visualization by clicking the context menu of WinCC RT Advanced > "Compile > Software (Rebuild all)".	
6.	Click the "VisuPC" PC station and, for a graphic representation of the scenarios, click the appropriate icon to start WinCC Runtime.	
7.	Now you can monitor the individual tags and the trend of the setpoint, process value and output value of the PID controllers.	For a description of the WinCC user interface, please refer to <a href="#">chapter 7</a> .

## 6.2 Startup with PLCSIM V14

### 6.2.1 Installing the software

This chapter describes the steps for installing the programs used.

Table 6-6 Installing the software components

No.	Action	Comment
1.	Install STEP 7 Professional V14	Follow the information provided in the system manual: <a href="#">3</a>
2.	Install PLCSIM V14	Follow the information provided in the system manual: <a href="#">3</a>
3.	Install WinCC Professional V14	Follow the information provided in the system manual: <a href="#">8</a>
4.	Download the sample project ( <a href="#">Table 2-5</a> ) from the Siemens Online Support page ( <a href="#">2</a> ).	

### 6.2.2 Configuring the engineering station

#### Changing the PG/PC interface

Table 6-7

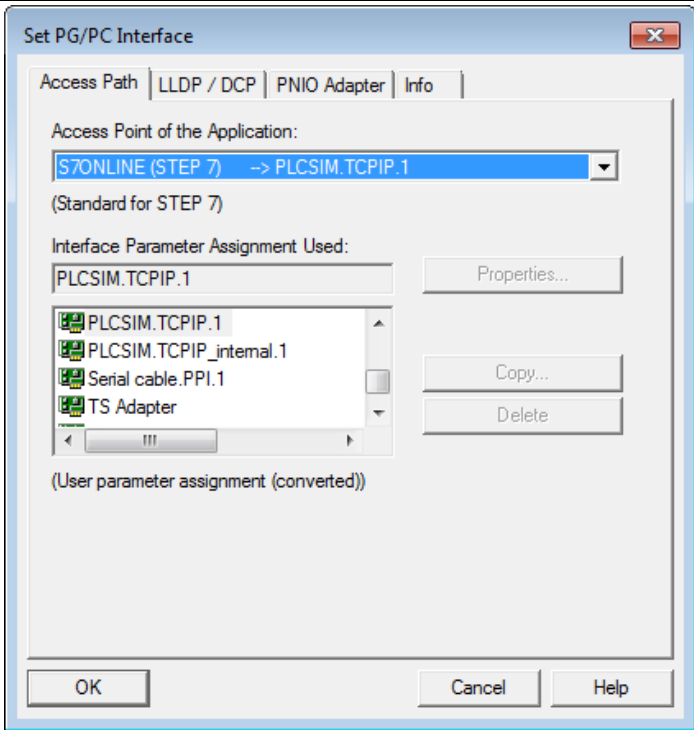
No	Action	Comment
1.	Use "Start > Control Panel" to go to the Control Panel and select the "Set PG/PC Interface" icon.	 <b>Set PG/PC Interface</b>
2.	Set your PG/PC interface to S7ONLINE (STEP 7) → PLCSIM.TCPIP1.	

## 6 Installation and Startup

### 6.2 Startup with PLCSIM V14

No.	Action	Comment
3.	Click OK to confirm the interface and the displayed warning message.	

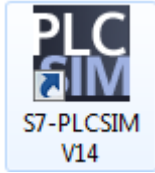
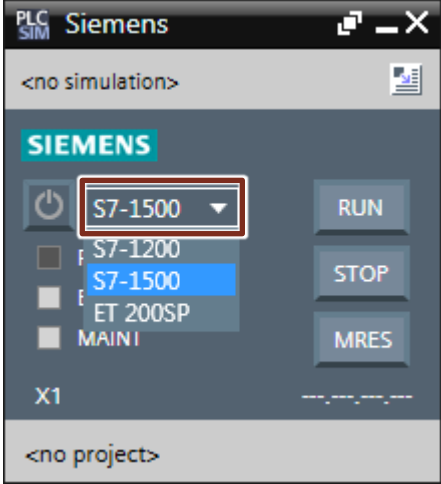
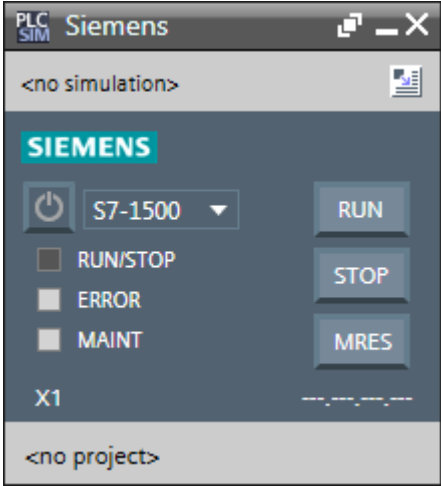

### Starting PLCSIM V14

Table 6-8

No.	Action	Comment
1.	Double-click the S7-PLCSIM V14 icon to start.	
2.	Select the PLC "S7-1500" to be simulated.	
3.	The simulated PLC is ready now.	

**6.2.3 Opening and downloading the TIA Portal project**

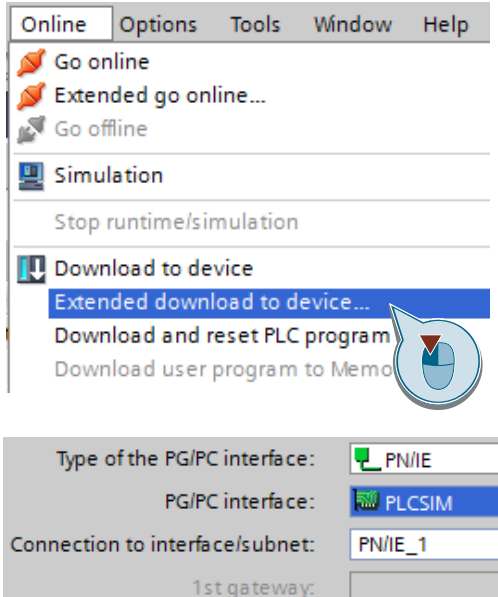
Table 6-9

No.	Action	Comment
1.	Download the zip project ( <a href="#">Table 2-5</a> ) to your engineering station and unzip the folder.	
2.	In the program folder, double-click the icon with the ".ap14" extension. The project now opens in TIA Portal V14.	
3.	Click the "PidCompactCPU1516" CPU and use "Online > Extended download to device" to download the user program to the CPU. Select the following interface for downloading: <ul style="list-style-type: none"> <li>• Type of the PG/PC interface: PN/IE</li> <li>• PG/PC interface: PLCSIM</li> <li>• Connection to interface/subnet: PN/IE_1</li> </ul>	
4.	Click the "VisuPC" PC station and, for a graphic representation of the scenarios, click the appropriate icon to start WinCC Runtime.	
5.	Now you can monitor the individual tags and the trend of the setpoint, process value and output value of the PID controllers.	For a description of the WinCC user interface, please refer to <a href="#">chapter 7</a> .

# 7 Operation of the application

## 7.1 Overview

For a better overview of the behavior of the implemented scenarios, several options are available to the user:

- Insight into the behavior of the control loops using the WinCC Runtime Advanced HMI system.
- Detailed insight into the current status of the control loop through the watch tables already prepared in the CPU.

## 7.2 Operation via WinCC Runtime

### 7.2.1 Control elements

The different scenarios can be selected from the start screen of the WinCC Runtime system running on the "VisuPC" PC station.

The WinCC Runtime screens contain the following elements:

Table 7-1

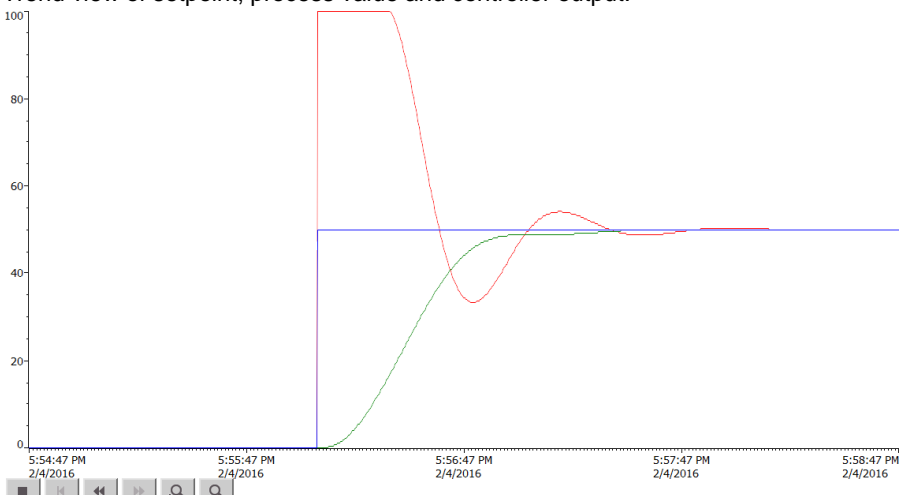
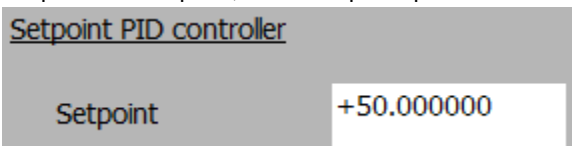
No.	Element																
1.	<p>Trend view of setpoint, process value and controller output.</p>  <table border="1"> <thead> <tr> <th>Trend</th> <th>Tag connection</th> <th>Value</th> <th>Date/Time</th> </tr> </thead> <tbody> <tr> <td>Setpoint</td> <td>PidCompact1_Setpoint</td> <td>50,000000</td> <td>2/4/2016 5:58:47:507 PM</td> </tr> <tr> <td>Input</td> <td>PidCompact1_Input</td> <td>49,997010</td> <td>2/4/2016 5:58:47:507 PM</td> </tr> <tr> <td>Output</td> <td>PidCompact1_Output</td> <td>50,031950</td> <td>2/4/2016 5:58:47:507 PM</td> </tr> </tbody> </table>	Trend	Tag connection	Value	Date/Time	Setpoint	PidCompact1_Setpoint	50,000000	2/4/2016 5:58:47:507 PM	Input	PidCompact1_Input	49,997010	2/4/2016 5:58:47:507 PM	Output	PidCompact1_Output	50,031950	2/4/2016 5:58:47:507 PM
Trend	Tag connection	Value	Date/Time														
Setpoint	PidCompact1_Setpoint	50,000000	2/4/2016 5:58:47:507 PM														
Input	PidCompact1_Input	49,997010	2/4/2016 5:58:47:507 PM														
Output	PidCompact1_Output	50,031950	2/4/2016 5:58:47:507 PM														
2.	<p>Output of the setpoint; manual input is possible.</p> 																
3.	<p>Output of the currently used PID parameters.</p>																

## 7 Operation of the application

### 7.2 Operation via WinCC Runtime

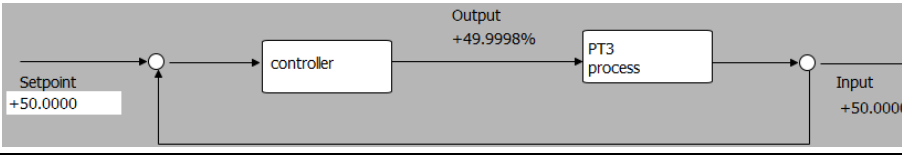
No.	Element						
	<p><u>PID parameters</u></p> <table border="1" data-bbox="470 353 874 577"> <tr> <td>Gain</td> <td>10.77034</td> </tr> <tr> <td>Ti</td> <td>21.10933 s</td> </tr> <tr> <td>Td</td> <td>5.33751 s</td> </tr> </table>	Gain	10.77034	Ti	21.10933 s	Td	5.33751 s
Gain	10.77034						
Ti	21.10933 s						
Td	5.33751 s						
4.	<p>Output of the PID controller.</p> <p><u>Output PID controller</u></p> <table border="1" data-bbox="470 622 874 745"> <tr> <td>Output</td> <td>+50.000</td> </tr> </table>	Output	+50.000				
Output	+50.000						
5.	<p>Overview screen of the control loop with current values.</p> 						
6.	<p>Mode display and mode selection buttons: Manual or automatic mode of the PID controller. When a mode is selected, the respective button is hidden. "Manual output" specifies the output value in manual mode. In automatic mode, the PID controller controls the output value.</p> <table border="1" data-bbox="470 1070 826 1328"> <tr> <td>State</td> <td>Automatic mode</td> </tr> <tr> <td colspan="2">           PID_Compact:            Mode: Manual         </td> </tr> <tr> <td colspan="2">           Manual output:            +0.000         </td> </tr> </table>	State	Automatic mode	PID_Compact: Mode: Manual		Manual output: +0.000	
State	Automatic mode						
PID_Compact: Mode: Manual							
Manual output: +0.000							
7.	<p>Navigation buttons to go the overview screen and stop WinCC Runtime.</p> <table border="1" data-bbox="470 1361 954 1426"> <tr> <td>Overview</td> <td>Stop RT</td> </tr> </table>	Overview	Stop RT				
Overview	Stop RT						





**7.2.2 Monitoring Scenario 2 with WinCC**

After commissioning the project, the two scenarios can be monitored using WinCC.

[Table 7-2](#) describes a possible monitoring scenario for Scenario2.

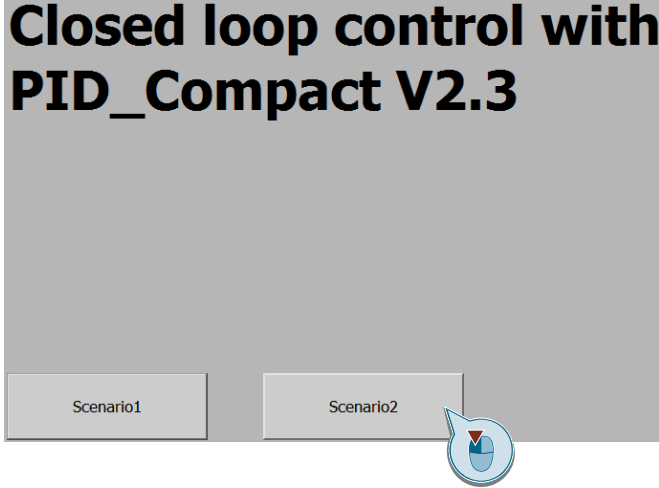
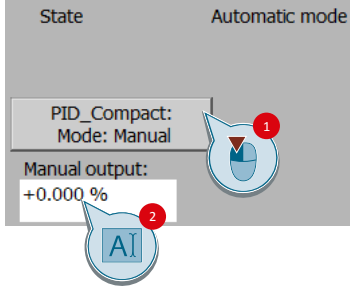
Table 7-2

No.	Action
1.	<p>Start the visualization and in the start screen, select "Scenario2".</p> 
2.	<p>To initially monitor a step response of the controlled system, select Manual mode (1).</p> <p>Set "Manual output" to any value (2).</p>  <p>Now you can monitor the system's step response to the trigger:</p> 

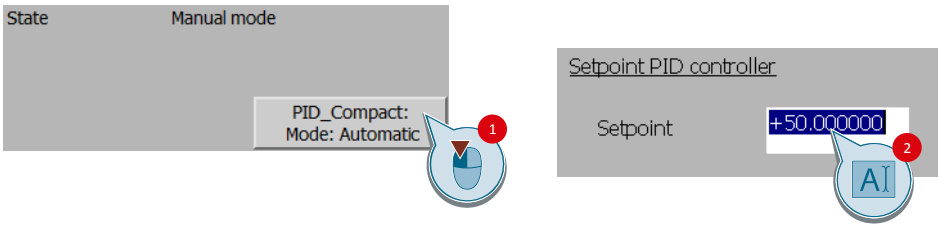
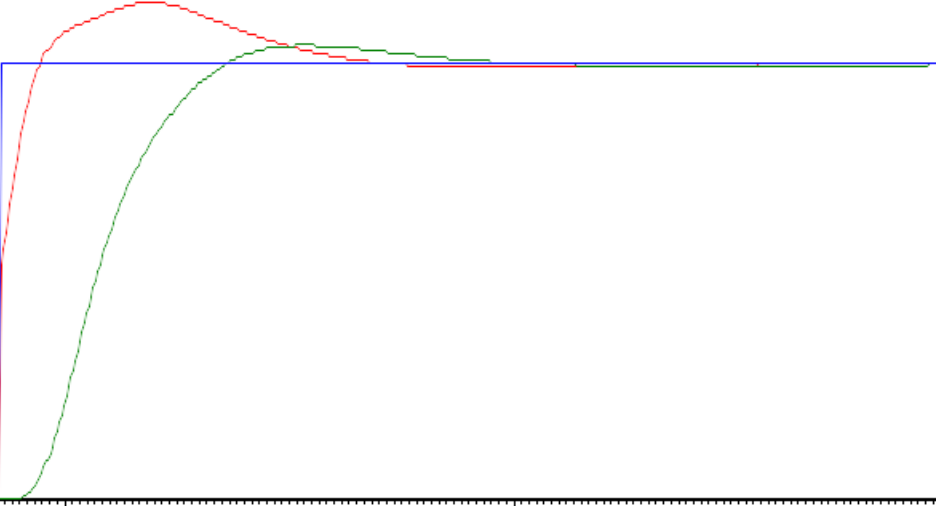
No.	Action
3.	<p>To monitor the control behavior, select Automatic mode (1) and define a setpoint (2).</p>  <p>Now you can monitor the behavior of the control loop:</p> 

## 7.3 Operator control and monitoring via online access

### Overview

You can analyze the S7 program of the CPU via CPU online access and the monitoring of blocks.

### Watch tables

Two watch tables have already been inserted into the project for support. They contain important parameters of the individual blocks for the individual scenarios. You will find the watch tables in the project tree of the "PidCompactCPU1516" folder in "Watch and force tables":

- WatchTableScenario1
- WatchTableScenario2

## 8 Related literature

### Book directory

Table 8-1

	Topic
\1\	Praxisbuch für Regelungen mit SIMATIC S7 und SIMATIC PCS 7 für die Prozessautomatisierung Authors: Müller/ Pfeiffer/ Wieser Publicis Publishing, Erlangen ISBN: 978-3-89578-340-1

### Link directory

Table 8-2

	Topic
\1\	Siemens Industry Online Support <a href="https://support.industry.siemens.com">https://support.industry.siemens.com</a>
\2\	Download page of this entry <a href="https://support.industry.siemens.com/cs/ww/en/view/79047707">https://support.industry.siemens.com/cs/ww/en/view/79047707</a>
\3\	System Manual: STEP 7 Professional V14 <a href="https://support.industry.siemens.com/cs/ww/en/view/109742272">https://support.industry.siemens.com/cs/ww/en/view/109742272</a>
\4\	Function Manual: SIMATIC S7-1200, S7-1500: PID Control <a href="https://support.industry.siemens.com/cs/ww/en/view/108210036">https://support.industry.siemens.com/cs/ww/en/view/108210036</a>
\5\	System Manual: SIMATIC S7-1500 Automation System <a href="https://support.industry.siemens.com/cs/ww/en/view/59191792">https://support.industry.siemens.com/cs/ww/en/view/59191792</a>
\6\	Getting Started: SIMATIC S7-1500: Installing the Assembly <a href="https://support.industry.siemens.com/cs/ww/en/view/71704272/52316681355">https://support.industry.siemens.com/cs/ww/en/view/71704272/52316681355</a>
\7\	Getting Started: SIMATIC S7-1500: Wiring <a href="https://support.industry.siemens.com/cs/ww/en/view/71704272/53386475915">https://support.industry.siemens.com/cs/ww/en/view/71704272/53386475915</a>
\8\	System Manual: WinCC Professional V14 <a href="https://support.industry.siemens.com/cs/ww/en/view/109742302">https://support.industry.siemens.com/cs/ww/en/view/109742302</a>
\9\	Application Example: "3-Point Stepper Control with SIMATIC S7-1500" <a href="https://support.industry.siemens.com/cs/ww/en/view/68011827">https://support.industry.siemens.com/cs/ww/en/view/68011827</a>
\10\	Application Example: „Single and Multi Loop Controller Structures (Cascade Control) with PID_Temp“ <a href="https://support.industry.siemens.com/cs/ww/en/view/103526819">https://support.industry.siemens.com/cs/ww/en/view/103526819</a>

## 9 History

Table 9-1

Version	Date	Modifications
V1.0	09/2013	First version
V2.0	03/2016	Update to "PID_Compact" V2.2 (TIA V13 SP1)
V2.0.1	03/2017	Adjustment <a href="#">Table 2-5</a>
V3.0.0	03/2017	Update to „PID_Compact“ V2.3 (TIA V14)