

SIEMENS



SIMATIC

S7-1500 / ET 200MP

Digital output module DQ 16x24VDC/0.5A BA (6ES7522-1BH10-0AA0)

Manual

Edition

09/2016

siemens.com

SIEMENS

SIMATIC

**S7-1500/ET 200MP
Digital output module
DQ 16x24VDC/0.5A BA
(6ES7522-1BH10-0AA0)**

Manual

Preface

Documentation guide

1

Product overview

2

Wiring

3

Address space

4

Diagnostics alarms

5

Technical specifications

6



Dimensional drawing

A

Legal information

Warning notice system

This manual contains notices you have to observe in order to ensure your personal safety, as well as to prevent damage to property. The notices referring to your personal safety are highlighted in the manual by a safety alert symbol, notices referring only to property damage have no safety alert symbol. These notices shown below are graded according to the degree of danger.

 DANGER
indicates that death or severe personal injury will result if proper precautions are not taken.
 WARNING
indicates that death or severe personal injury may result if proper precautions are not taken.
 CAUTION
indicates that minor personal injury can result if proper precautions are not taken.
NOTICE
indicates that property damage can result if proper precautions are not taken.

If more than one degree of danger is present, the warning notice representing the highest degree of danger will be used. A notice warning of injury to persons with a safety alert symbol may also include a warning relating to property damage.

Qualified Personnel

The product/system described in this documentation may be operated only by **personnel qualified** for the specific task in accordance with the relevant documentation, in particular its warning notices and safety instructions. Qualified personnel are those who, based on their training and experience, are capable of identifying risks and avoiding potential hazards when working with these products/systems.

Proper use of Siemens products

Note the following:

 WARNING
Siemens products may only be used for the applications described in the catalog and in the relevant technical documentation. If products and components from other manufacturers are used, these must be recommended or approved by Siemens. Proper transport, storage, installation, assembly, commissioning, operation and maintenance are required to ensure that the products operate safely and without any problems. The permissible ambient conditions must be complied with. The information in the relevant documentation must be observed.

Trademarks

All names identified by ® are registered trademarks of Siemens AG. The remaining trademarks in this publication may be trademarks whose use by third parties for their own purposes could violate the rights of the owner.

Disclaimer of Liability

We have reviewed the contents of this publication to ensure consistency with the hardware and software described. Since variance cannot be precluded entirely, we cannot guarantee full consistency. However, the information in this publication is reviewed regularly and any necessary corrections are included in subsequent editions.

Preface

Purpose of the documentation

This manual supplements the system manual S7-1500/ET 200MP (<https://support.industry.siemens.com/cs/ww/en/view/59191792>).

Functions that relate in general to the systems are described in this system manual.

The information provided in this manual and in the system/function manuals supports you in commissioning the systems.

Changes compared to previous version

Compared to the previous version, this manual contains the following change:

Original texts of the license conditions and copyright notes for open-source software are available on the Internet as of 09/2016.

Conventions

The term "CPU" is used in this manual both for the CPUs of the S7-1500 automation system and for interface modules of the ET 200MP distributed I/O system.

Please also observe notes marked as follows:

Note

A note contains important information on the product described in the documentation, on the handling of the product or on the section of the documentation to which particular attention should be paid.

Security information

Siemens provides products and solutions with industrial security functions that support the secure operation of plants, systems, machines and networks.

In order to protect plants, systems, machines and networks against cyber threats, it is necessary to implement – and continuously maintain – a holistic, state-of-the-art industrial security concept. Siemens' products and solutions only form one element of such a concept.

Customer is responsible to prevent unauthorized access to its plants, systems, machines and networks. Systems, machines and components should only be connected to the enterprise network or the internet if and to the extent necessary and with appropriate security measures (e.g. use of firewalls and network segmentation) in place.

Additionally, Siemens' guidance on appropriate security measures should be taken into account. For more information about industrial security, please visit (<http://www.siemens.com/industrialsecurity>).

Siemens' products and solutions undergo continuous development to make them more secure. Siemens strongly recommends to apply product updates as soon as available and to always use the latest product versions. Use of product versions that are no longer supported, and failure to apply latest updates may increase customer's exposure to cyber threats.

To stay informed about product updates, subscribe to the Siemens Industrial Security RSS Feed under (<http://www.siemens.com/industrialsecurity>).

Open Source Software

Open-source software is used in the firmware of the I/O modules. Open Source Software is provided free of charge. We are liable for the product described, including the open-source software contained in it, pursuant to the conditions applicable to the product. Siemens accepts no liability for the use of the open source software over and above the intended program sequence, or for any faults caused by modifications to the software.

For legal reasons, we are obliged to publish the original text of the license conditions and copyright notices. Please read the information relating to this on the Internet (<https://support.industry.siemens.com/cs/ww/en/view/109741045>).

Table of contents

	Preface	4
1	Documentation guide	7
2	Product overview	11
	2.1 Properties	11
3	Wiring	13
4	Address space	15
	4.1 Address space	15
5	Diagnostics alarms	19
	5.1 Status and error displays	19
6	Technical specifications	21
A	Dimensional drawing	25

Documentation guide

The documentation for the SIMATIC S7-1500 automation system, the CPU 1516pro-2 PN based on SIMATIC S7-1500 and the SIMATIC ET 200MP distributed I/O system is arranged into three areas.

This arrangement enables you to access the specific content you require.

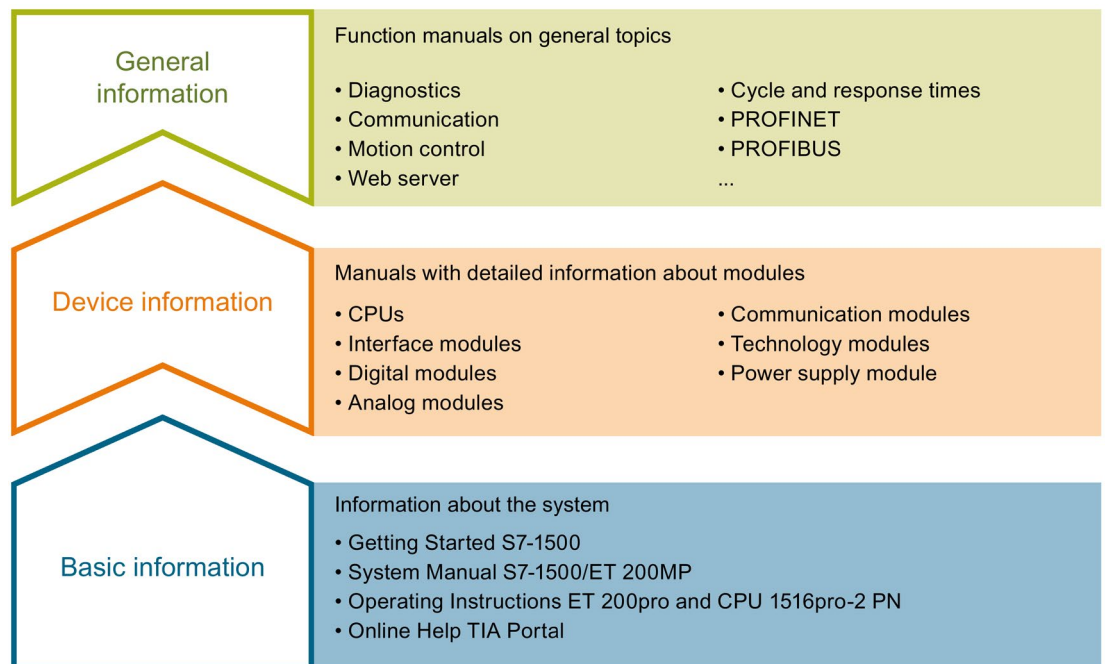

Basic information

The System Manual and Getting Started describe in detail the configuration, installation, wiring and commissioning of the SIMATIC S7-1500 and ET 200MP systems. For CPU 1516pro-2 PN you use the corresponding operating instructions. The STEP 7 online help supports you in the configuration and programming.

Device information

Product manuals contain a compact description of the module-specific information, such as properties, wiring diagrams, characteristics and technical specifications.

General information

The function manuals contain detailed descriptions on general topics regarding the SIMATIC S7-1500 and ET 200MP systems, e.g. diagnostics, communication, motion control, Web server, OPC UA.

You can download the documentation free of charge from the Internet (<http://w3.siemens.com/mcms/industrial-automation-systems-simatic/en/manual-overview/Pages/Default.aspx>).

Changes and supplements to the manuals are documented in a Product Information.

You can download the product information free of charge from the Internet (<https://support.industry.siemens.com/cs/us/en/view/68052815>).

Manual Collection S7-1500/ET 200MP

The Manual Collection contains the complete documentation on the SIMATIC S7-1500 automation system and the ET 200MP distributed I/O system gathered together in one file.

You can find the Manual Collection on the Internet (<https://support.industry.siemens.com/cs/ww/en/view/86140384>).

SIMATIC S7-1500 comparison list for programming languages

The comparison list contains an overview of which instructions and functions you can use for which controller families.

You can find the comparison list on the Internet (<https://support.industry.siemens.com/cs/ww/en/view/86630375>).

"mySupport"

With "mySupport", your personal workspace, you make the best out of your Industry Online Support.

In "mySupport", you can save filters, favorites and tags, request CAx data and compile your personal library in the Documentation area. In addition, your data is already filled out in support requests and you can get an overview of your current requests at any time.

You must register once to use the full functionality of "mySupport".

You can find "mySupport" on the Internet (<https://support.industry.siemens.com/My/ww/en>).

"mySupport" - Documentation

In the Documentation area in "mySupport" you can combine entire manuals or only parts of these to your own manual.

You can export the manual as PDF file or in a format that can be edited later.

You can find "mySupport" - Documentation on the Internet (<http://support.industry.siemens.com/My/ww/en/documentation>).

"mySupport" - CAx data

In the CAx data area in "mySupport", you can access the current product data for your CAx or CAe system.

You configure your own download package with a few clicks.

In doing so you can select:

- Product images, 2D dimension drawings, 3D models, internal circuit diagrams, EPLAN macro files
- Manuals, characteristics, operating manuals, certificates
- Product master data

You can find "mySupport" - CAx data on the Internet (<http://support.industry.siemens.com/my/ww/en/CAxOnline>).

Application examples

The application examples support you with various tools and examples for solving your automation tasks. Solutions are shown in interplay with multiple components in the system - separated from the focus on individual products.

You will find the application examples on the Internet (<https://support.industry.siemens.com/sc/ww/en/sc/2054>).

TIA Selection Tool

With the TIA Selection Tool, you can select, configure and order devices for Totally Integrated Automation (TIA).

This tool is the successor of the SIMATIC Selection Tool and combines the known configurators for automation technology into one tool.

With the TIA Selection Tool, you can generate a complete order list from your product selection or product configuration.

You can find the TIA Selection Tool on the Internet (<http://w3.siemens.com/mcms/topics/en/simatic/tia-selection-tool>).

SIMATIC Automation Tool

You can use the SIMATIC Automation Tool to run commissioning and maintenance activities simultaneously on various SIMATIC S7 stations as a bulk operation independently of the TIA Portal.

The SIMATIC Automation Tool provides a multitude of functions:

- Scanning of a PROFINET/Ethernet network and identification of all connected CPUs
- Address assignment (IP, subnet, gateway) and station name (PROFINET device) to a CPU
- Transfer of the date and the programming device/PC time converted to UTC time to the module
- Program download to CPU
- Operating mode switchover RUN/STOP
- Localization of the CPU by means of LED flashing
- Reading out CPU error information
- Reading the CPU diagnostic buffer
- Reset to factory settings
- Updating the firmware of the CPU and connected modules

You can find the SIMATIC Automation Tool on the Internet (<https://support.industry.siemens.com/cs/ww/en/view/98161300>).

PRONETA

With SIEMENS PRONETA (PROFINET network analysis), you analyze the PROFINET network during commissioning. PRONETA features two core functions:

- The topology overview independently scans PROFINET and all connected components.
- The IO check is a fast test of the wiring and the module configuration of a system.

You can find SIEMENS PRONETA on the Internet (<https://support.industry.siemens.com/cs/ww/en/view/67460624>).

Product overview

2.1 Properties

Article number

6ES7522-1BH10-0AA0

View of the module

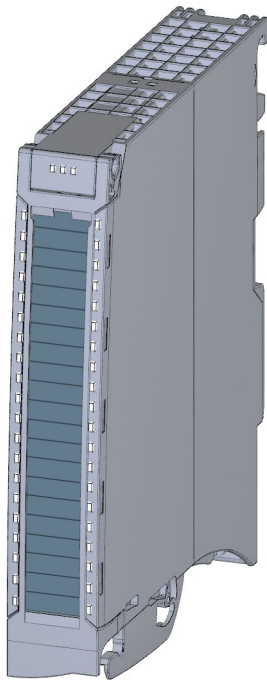

Figure 2-1 View of the DQ 16x24VDC/0.5A BA module

Properties

The digital module has the following technical properties:

- 16 digital outputs, electrically isolated in groups of 8
- Rated output voltage 24 V DC
- Rated output current 0.5 A per channel
- Suitable for solenoid valves, DC contactors, and indicator lights

The module supports the following functions:

Table 2- 1 Version dependencies of the module functions

Function	Firmware version of the module	Configuration software	
		STEP 7 (TIA Portal)	GSD file in STEP 7 (TIA Portal) V12 or higher, or STEP 7 V5.5 SP3 or higher
Firmware update	V1.0.0 or higher	V13 or higher	--- / X
Identification data I&M0 to I&M3	V1.0.0 or higher	V13 or higher	X
Module-internal Shared Output (MSO)	V1.0.0 or higher	V13 Update 3 or higher (PROFINET IO only)	X (PROFINET IO only)
Configurable submodules / submodules for Shared Device	V1.0.0 or higher	V13 Update 3 or higher (PROFINET IO only)	X (PROFINET IO only)

You can configure the module with STEP 7 (TIA Portal) and with a GSD file.

Accessories

The following accessories are supplied with the module and can also be ordered separately as spare parts:

- Front connector (push-in terminals) including cable tie
- Labeling strips
- U connector
- Universal front door

You can find additional information on accessories in the system manual S7-1500/ET 200MP (<https://support.industry.siemens.com/cs/ww/en/view/59191792>).

Wiring

This section contains the block diagram of the module and outlines various wiring options.

You can find information on wiring the front connector, creating a cable shield, etc. in the Wiring section of the S7-1500/ET 200MP

(<https://support.industry.siemens.com/cs/ww/en/view/59191792>) system manual.

Wiring and block diagram

The example in the following figure shows the terminal assignment and the assignment of the channels to the addresses (output byte a and output byte b).

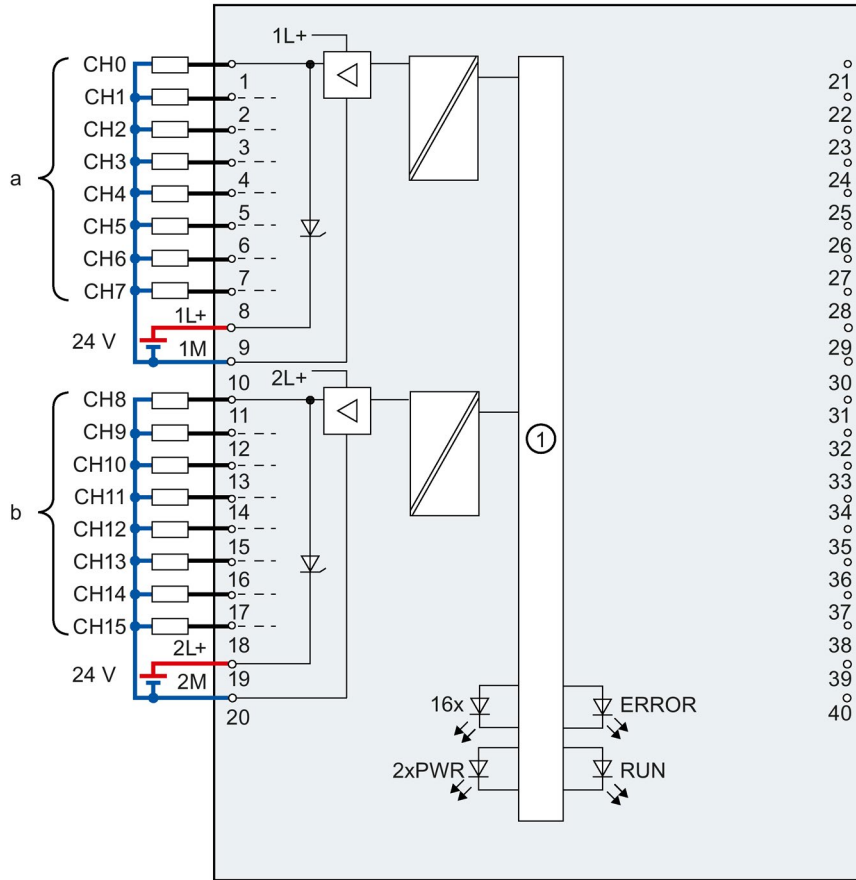

①	Backplane bus interface	CHx	Channel or channel status LED (green)
xL+	Supply voltage 24 V DC	RUN	Status display LED (green)
xM	Ground	ERROR	Error display LED (red)
		PWR	POWER supply voltage LED (green)

Figure 3-1 Block diagram and terminal assignment

Note

Upon activation of the 24 V supply voltage, there is a "1" signal at the module outputs for approx. 50 µs.

Address space

4.1 Address space

The module can be configured in various ways in STEP 7. Depending on the configuration, additional/different addresses are assigned in the process image output/input.

Configuration options of DQ 16x24VDC/0.5A BA

You can configure the module with STEP 7 (TIA Portal) or with a GSD file.

When you configure the module by means of the GSD file, the configurations are available under different short designations/module names.

The following configurations are possible:

Table 4- 1 Configuration options

Configuration	Short designation/module name in the GSD file	Configuration software, e.g., with STEP 7 (TIA Portal)	
		Integrated in hardware catalog STEP 7 (TIA Portal)	GSD file in STEP 7 (TIA Portal) V12 or higher or STEP 7 V5.5 SP3 or higher
1 x 16-channel without value status	DQ 16x24VDC/0.5A BA	V13 or higher	X
2 x 8-channel without value status	DQ 16x24VDC/0.5A BA S	V13 Update 3 or higher (PROFINET IO only)	X (PROFINET IO only)
1 x 16-channel with value status for module-internal Shared Output with up to 4 submodules	DQ 16x24VDC/0.5A BA MSO	V13 Update 3 or higher (PROFINET IO only)	X (PROFINET IO only)

4.1 Address space

Address space for configuration as 1 x 16-channel DQ 16x24VDC/0.5A BA

The figure below shows the address space assignment for configuration as a 1 x 16-channel module. You can freely assign the start address for the module. The addresses of the channels are derived from the start address.

The letters "a to d" are printed on the module- "QB a", for example, stands for module start address output byte a.

Assignment in the process image output (PIQ)

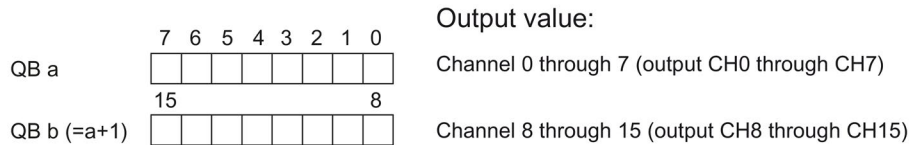

Figure 4-1 Address space for configuration as 1 x 16-channel DQ 16x24VDC/0.5A BA

Address space for configuration as 2 x 8-channel DQ 16x24VDC/0.5A BA S

For the configuration as a 2 x 8-channel module, the channels of the module are divided into multiple submodules. The submodules can be assigned to different IO controllers when the module is used in a shared device.

The number of usable IO controllers depends on the interface module used. Please observe the information in the manual for the particular interface module.

Unlike the 1 x 16-channel module configuration, each of the two submodules has a freely assignable start address.

Assignment in the process image output (PIQ)

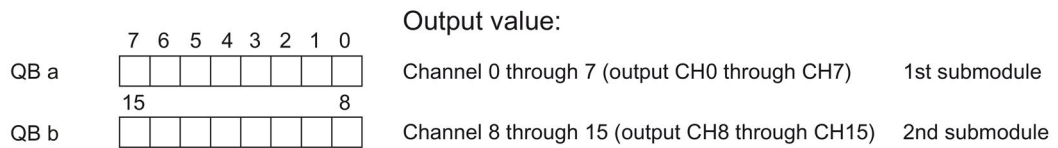

Figure 4-2 Address space for configuration as 2 x 8-channel DQ 32x24VDC/0.5A BA S

Address space for configuration as 1 x 16-channel DQ 16x24VDC/0.5A BA MSO

For the configuration as a 1 x 16-channel module (module-internal Shared Output, MSO), channels 0 to 15 of the module are copied to multiple submodules. Channels 0 to 16 are then available with identical values in various submodules. These submodules can be assigned to up to four IO controllers when the module is used in a shared device:

- The IO controller to which submodule 1 is assigned has write access to outputs 0 to 15.
- The IO controllers to which submodule 2, 3, or 4 is assigned have read access to outputs 0 to 15.

The number of usable IO controllers depends on the interface module used. Please observe the information in the manual for the particular interface module.

Value status (Quality Information, QI)

The meaning of the value status depends on the submodule involved.

For the 1st submodule (=basic submodule), the value status 1 indicates that the output value specified by the user program is actually output at the module terminal.

Possible causes for value status = 0:

- Value is incorrect, for example, because the supply voltage is missing.
- IO controller of the basic submodule is in STOP mode.

For the 2nd to 4th submodule (=MSO submodule), the value status 1 indicates that the output value specified by the user program is actually output at the module terminal.

Possible causes for value status = 0:

- Value is incorrect, for example, because the supply voltage is missing.
- IO controller of the basic submodule is in STOP mode.
- The basic submodule is not yet configured.

The figure below shows the assignment of the address space for submodules 1 and 2.

Assignment in the process image output (PIQ) for 1st submodule

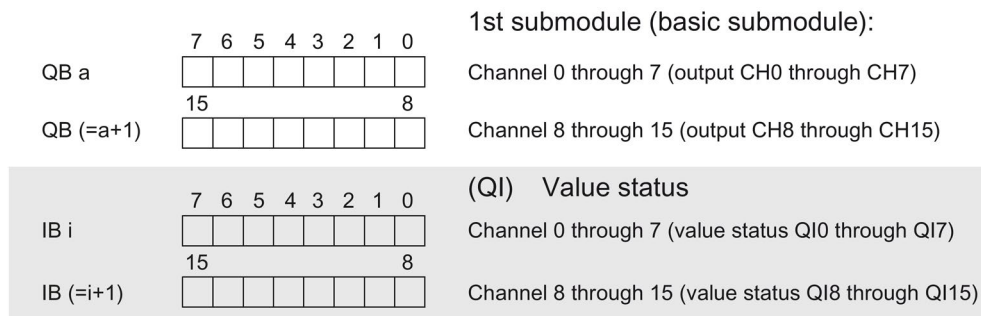

Assignment in the process image input (PII) for 2nd submodule

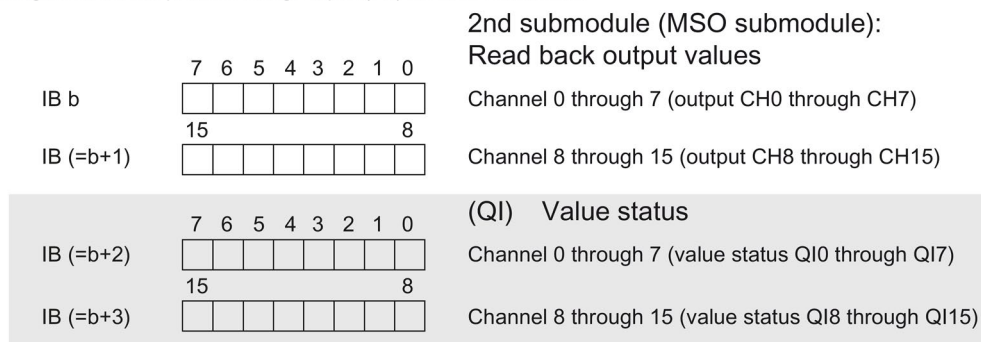

0 = value read in on channel is faulty

Figure 4-3 Address space for configuration as 1 x 16-channel DQ 16x24VDC/0.5A BA MSO with value status

4.1 Address space

The figure below shows the assignment of the address space with submodules 3 and 4.

Assignment in the process image input (PII) for 3rd and 4th submodule

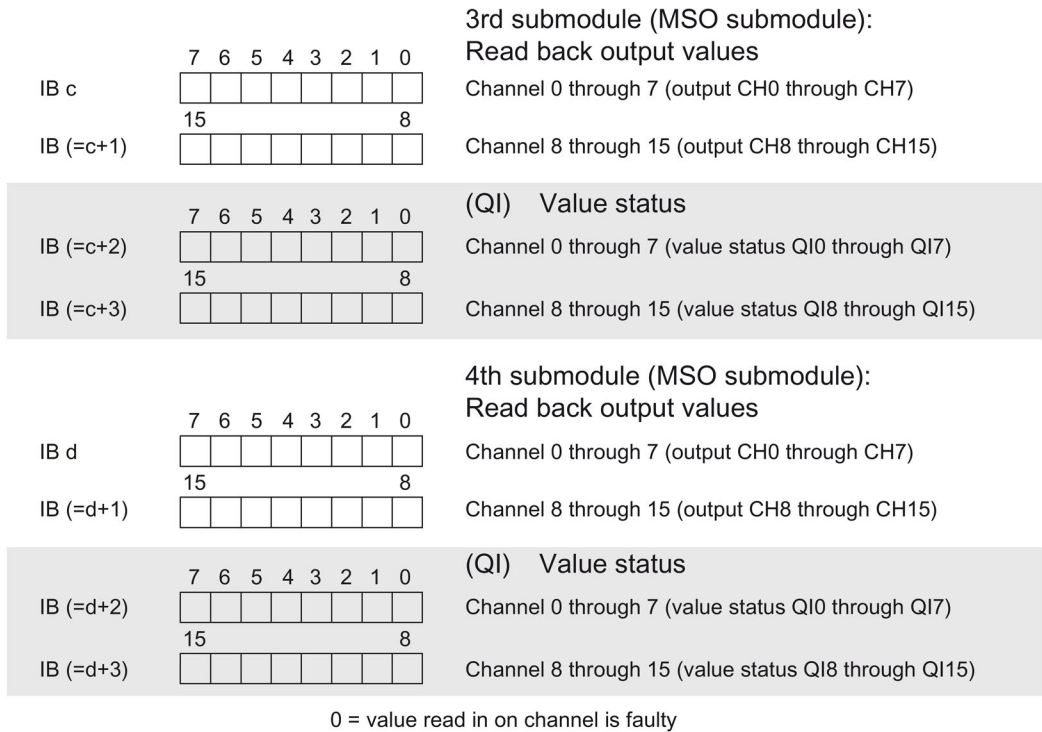

Figure 4-4 Address space for configuration as 1 x 16-channel DQ 16x24VDC/0.5A BA MSO with value status

Reference

You can find information on the Shared Input/Output (MSI/MSO) function in the section Module-Internal Shared Input/Output (MSI/MSO) of the PROFINET with STEP 7 V13 (<https://support.industry.siemens.com/cs/ww/en/view/49948856>) function manual.

Diagnostics alarms

The module has no selectable diagnostics. Diagnostics alarms, for example, cannot be output with STEP 7 (TIA Portal).

5.1 Status and error displays

LED displays

The figure below shows you the LED displays (status and error displays) of the DQ 16x24VDC/0.5A BA.

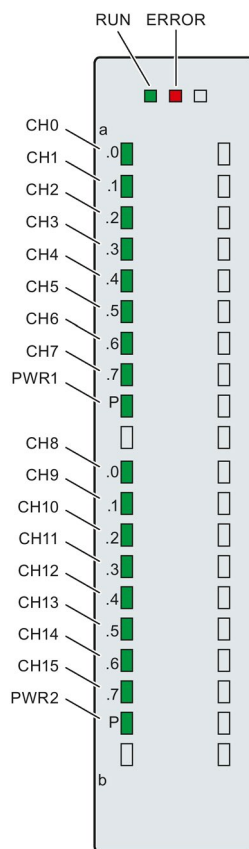









Figure 5-1 LED displays of the module DQ 16x24VDC/0.5A BA

Meaning of the LED displays

The tables below explain the meaning of the status and error displays.



LED RUN/ERROR

Table 5- 1 RUN/ERROR status and error displays

LED		Meaning	Remedy
RUN	ERROR		
 Off	 Off	Voltage missing or too low at backplane bus.	<ul style="list-style-type: none"> Switch on the CPU and/or the system power supply modules. Verify that the U connectors are inserted. Check to see if too many modules are inserted.
 Flashes	 Off	Module is starting up.	---
 On	 Off	Module is ready.	---
 Flashes	 Flashes	Hardware defective.	Replace the module.



LED PWR1/PWR2

Table 5- 2 PWR1/PWR2 status display

LED PWRx	Meaning	Remedy
 Off	Supply voltage L+ too low or missing.	Check the L+ supply voltage.
 On	Supply voltage L+ is present and OK.	---

LED CHx

Table 5- 3 CHx status display

LED CHx	Meaning	Remedy
 Off	0 = Status of the output signal.	---
 On	1 = Status of the output signal.	---

Technical specifications

Technical specifications of the DQ 16x24VDC/0.5A BA

	6ES7522-1BH10-0AA0
General information	
Product type designation	DQ 16x24VDC/0,5A BA
Hardware functional status	FS01
Firmware version	V1.0.0
<ul style="list-style-type: none"> FW update possible 	Yes
Product function	
I&M data	Yes; I&M0 to I&M3
Engineering with	
STEP 7 TIA Portal can be configured/integrated as of version	V13 / V13
STEP 7 can be configured/integrated as of version	V5.5 SP3 / -
PROFIBUS as of GSD version/GSD revision	V1.0 / V5.1
PROFINET as of GSD version/GSD revision	V2.3 / -
Operating mode	
DQ	Yes
DQ with energy-saving function	No
PWM	No
Oversampling	No
MSO	Yes
Supply voltage	
Rated value (DC)	24 V
Valid range, low limit (DC)	20.4 V
Valid range, high limit (DC)	28.8 V
Reverse polarity protection	Yes; through internal protection with 7 A per group
Input current	
Current consumption, max.	30 mA
Output voltage	
Rated value (DC)	24 V
Power	
Power consumption from the backplane bus	1.15 W
Power loss	
Power loss, typ.	2.2 W

	6ES7522-1BH10-0AA0
Digital outputs	
Number of outputs	16
Sourcing output	Yes
Short-circuit protection	Yes
<ul style="list-style-type: none"> • Response threshold, typ. 	1 A
Limitation of inductive shutdown voltage to	L+ (-53 V)
Control of a digital input	Yes
Switching capacity of outputs	
With resistive load, max.	0.5 A
With lamp load, max.	5 W
Load resistance range	
Low limit	48 Ω
High limit	12 kΩ
Output voltage	
For signal "1", min.	L+ (-0.8 V)
Output current	
For signal "1" rated value	0.5 A
For signal "1" permitted range, max.	0.5 A
For signal "0" residual current, max.	0.5 mA
Output delay with resistive load	
"0" to "1", max.	100 μs
"1" to "0", max.	500 μs
Parallel connection of two outputs	
For logic operations	Yes
For increased performance	No
For redundant control of a load	Yes
Switching frequency	
With resistive load, max.	100 Hz
With inductive load, max.	0.5 Hz; according to IEC 60947-5-1, DC-13
With lamp load, max.	10 Hz
Total current of outputs	
Current per channel, max.	0.5 A; see additional description in the manual
Current per group, max.	4 A; see additional description in the manual
Current per module, max.	8 A; see additional description in the manual
Cable length	
shielded, max.	1000 m
unshielded, max.	600 m
Isochronous mode	
Isochronous mode (application synchronized up to terminal)	No
Interrupts/diagnostics/status information	
Diagnostics function	No
Substitute values can be applied	No

6ES7522-1BH10-0AA0	
Interrupts	
Diagnostic interrupt	No
Diagnostics alarms	
Monitoring of supply voltage	No
Wire break	No
Short-circuit	No
Group error	No
Diagnostics indicator LED	
RUN LED	Yes; green LED
ERROR LED	Yes; red LED
Monitoring of supply voltage (PWR LED)	Yes; green LED
Channel status display	Yes; green LED
For channel diagnostics	No
For module diagnostics	No
Electrical isolation	
Electrical isolation of channels	
Between the channels	No
Between the channels, in groups of	8
Between the channels and backplane bus	Yes
Insulation	
Insulation tested with	707 V DC (type test)
Distributed operation	
Prioritized startup	Yes
Dimensions	
Width	25 mm
Height	147 mm
Depth	129 mm
Weights	
Weight, approx.	230 g
Miscellaneous	
Note:	Delivery includes 40-pin push-in front connector

Power reduction (derating) to aggregate current of outputs (per group)

The following derating graphs show the loading capacity of the outputs in relation to the mounting position of the S71500 automation system/ET 200MP distributed I/O system and the ambient temperature.

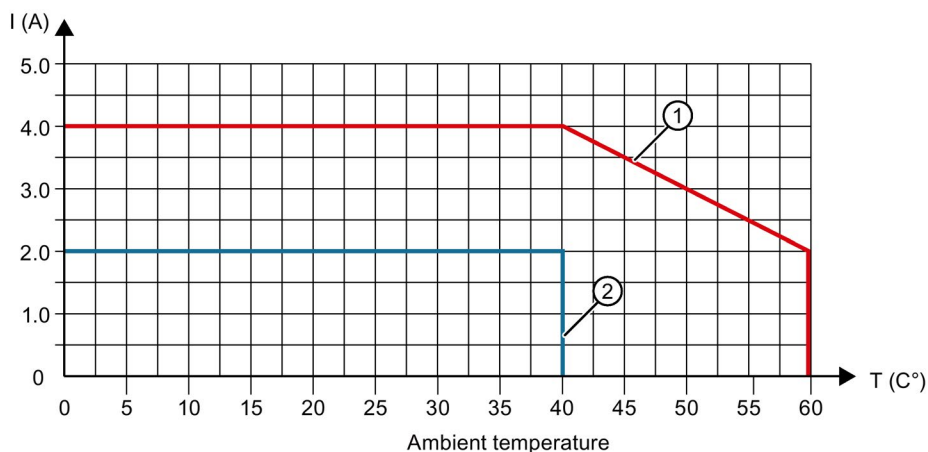

- ① Horizontal mounting of the system
- ② Vertical mounting of the system

Figure 6-1 Details on aggregate current of outputs (per group)

Dimensional drawing

A

The dimensional drawing of the module on the mounting rail, as well as a dimensional drawing with open front cover, are provided in this appendix. Always observe the specified dimensions for installation in cabinets, control rooms, etc.

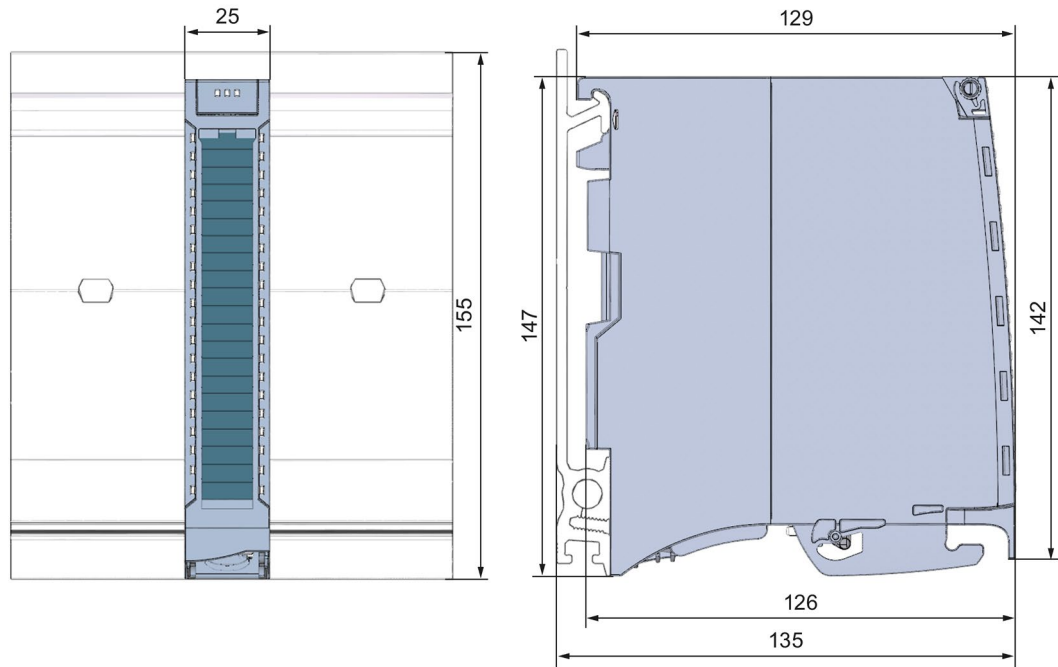

Figure A-1 Dimensional drawing of the DQ 16x24VDC/0.5A BA module

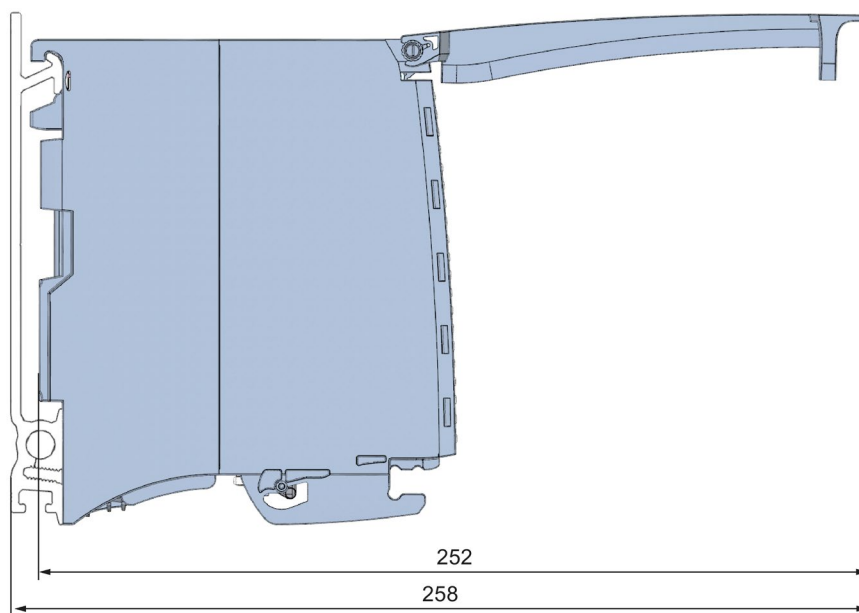

Figure A-2 Dimensional drawing of the DQ 16x24VDC/0.5A BA module, side view with open front cover